

EN 4.2

Content

New at KESSEL	4	1. Backwater protection	16
This is KESSEL	6	1.1 Backwater valves	24
KESSEL Worldwide	8	1.2 Backwater chambers	58
Individual solutions	10	2. Hybrid lifting stations	66
KESSEL SmartServices	12	2.1 Backwater pumping stations	70
Quality	14	2.2 Hybrid lifting stations	78
Integrated management system	15	3. Lifting and Pumping stations	96
		3.1 Lifting stations (above ground)	106
		3.2 Pumping stations (below ground)	142
		3.3 Submersible pumps, conversion and control units	172
		4. Drains and Channels	182
		4.1 Bathroom drains	192
		4.2 Floor drains	230
		4.3 Basement drains	280
		4.4 Outdoor drains	302
		5. Separators	324
		5.1 Grease separators	328
		5.2 Coalescence / Oil-/Fuel separators	388
		5.3 Sediment separators	400
		5.4 Starch separators	404
		Article Index	408

New at KESSEL



Our 2023 innovations



Lifting station
Minilift S

The space-saving version for sewage-free wastewater.

➤ Page 132

Hybrid lifting station
Ecolift L

The intelligent alternative to a lifting station.

➤ Page 87



Floor drain / Channel drains /
Square channel drains

Ferrofix

The steel solution for trade and industry.

➤ Page 250





Basement drain
Universale Plus

New, versatile and more affordable than ever.

➤ Page 286



Grease separator
EasyClean free UnderSink

The handy solution for small water quantities.

➤ Page 369



Grease separator
EasyClean ground Multi

Grease separator and pumping station in one chamber.

➤ Page 381



Grease separator
EasyClean ground oval

Now also available as single dome separators.

➤ Page 374

This is KESSEL.

Since 1963, KESSEL has stood like no other company for innovative and reliable drainage technology. We have established ourselves as the impulse generator in the industry and are now a worldwide premium supplier.



Competent partner
since 1963



International player
**60+
countries**



Innovative premium supplier
**3.000+
products**



Safe employer
**765
employees**



Sustainable company
**141,5 mio. €
in sales**

During the production of our products as well as their operation on-site, we keep quality assurance, environmental protection and worker's safety at the top of our list.

We also place great value in the relationship with our customer, providing consultation, installation support, commissioning and after-sales service.

One thing is certain, our innovation, quality, reliability and service is number one in the industry.

KESSEL – Leading in drainage



Made in Germany



KESSEL Headquarters Lenting, Germany

Leading in drainage.

No matter whether the task involves discharging water, wastewater treatment or backwater protection: if the best solution is required, there is no option but KESSEL.



Backwater protection

Backwater valves
Backwater chambers



Pump technology

Backwater pumping station
Hybrid lifting station
Lifting stations
Pumping stations
Submersible pumps,
conversions and control units



Drains & channels

Bathroom drains
Floor drains
Basement drains
Outdoor drains



Separators

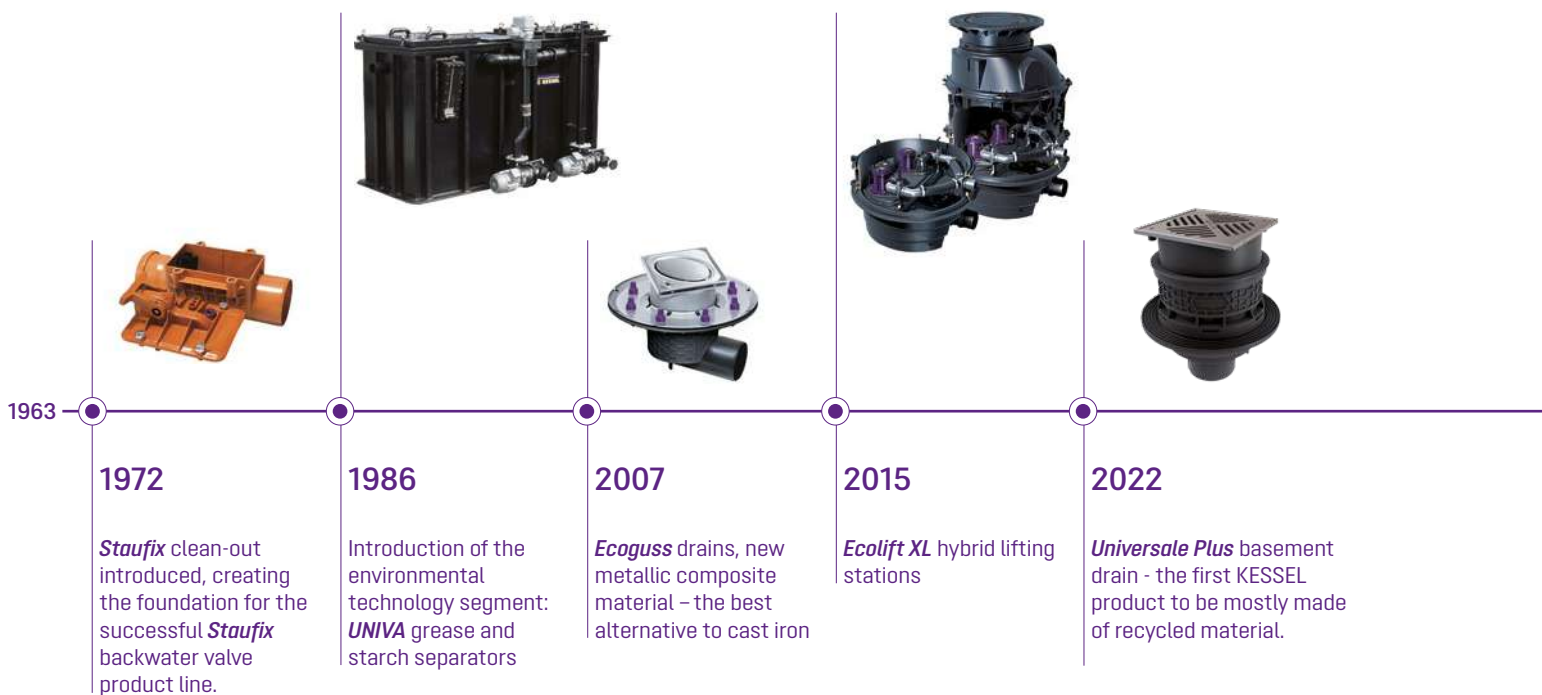
Grease separators
Coalescence / Oil /
Fuel separators
Sediment separators
Starch separators

KESSEL Worldwide

KESSEL supplies our market leading drainage products to over 60 countries throughout the world. For any questions you may have, please contact our local partner in your country.



● KESSEL offices ○ Partners worldwide



Individual solutions

For over 20 years we have been developing tailor-made drainage solutions for the specific requirements of our customers.

Our extensive knowledge of polymer engineering enables us to respond to your particular needs at any time. This means we can offer you almost unlimited product variety. To date, we have successfully installed around 20,000 customised solutions.

Our product lines

- Lifting stations
- Drains and channels
- Separators
- Hybrid lifting stations
- Backwater protection
- Chambers



Individual solutions

info@kessel.com



Product adaptation

If a particular shape, size or function of the product is required, we can carry out minor or major modifications to the product to meet these specifications.



Standard solution

Draining water, treating wastewater, protecting against backwater: all the standard drainage tasks are covered by our standard portfolio.



New development

If the range of tasks differs from the usual framework to an extreme extent, we also develop completely new products for your specific application.

KESSEL SmartServices

Our digital services offer



Stay up to date:
get always the newest information
about KESSEL and our products



BIM



LinkedIn



Facebook



SmartSelect




Youtube

With KESSEL SmartServices the future has already arrived for each of our drainage products. For you as a customer, this not only means extensive digital support for design, installation and operation – but also the certainty that we continue to develop our services for your benefit.



Planning

 **Building Information Modelling (BIM)**

All component information for dependable planning.

 **CAD data**

Drawing with AutoCAD & similar software.


 **Specification texts**

Simple management of article master data.

 **Design information**

Detailed guide.

Installation

 **Building Information Modelling (BIM)**

All important component information for dependable installation.

 **Assembly/installation videos**

Illustrated installation tips.

 **Installation instructions**

Proper installation, step-by-step.

Operation

 **Building Information Modelling (BIM)**


All important component information for dependable operation and maintenance.

 **Spare parts catalogue**

Spare parts for maintenance and repair.

 **Function videos**

Illustrated product explanations.

 **User manuals**

Online library for product manuals.

 **SmartSelect**

Design tool for lifting stations and grease separators.

 **SonicControl**

Automatic layer thickness measurement for separators.

 **Spare part finder**

Selection tool for suitable spare parts.

Quality

Our promise

The KESSEL name stands for the highest quality. That is why our manufacturing is carried out where we can guarantee our customers the best quality. And this is why the town of Lenting, near Ingolstadt, Germany, has been our main site since 1979. For us, "Made in Germany" is not a marketing slogan, but rather the basis for the KESSEL quality promise. In order to remain at the peak, we are continuously optimising our internal processes – backed by ISO management standards.



DGNB

Member of the association for sustainable construction ["DGNB e. V."] for long-term sustainable quality in construction products.



TÜV Rheinland

type tested and monitored.



SKZ test seal

The quality seal testifies that the tested products have successfully passed through the testing, monitoring and certification stages.



Information on ATEX products

Proof that a device complies with the ATEX product guideline 2014/34/EU. For devices and protection systems for proper use in potentially explosive areas, e.g. volatile liquid separators.



CE mark

Proof that the manufacturer is compliant with the directive 93/42/EEC for Europe-wide regulation of construction products. National requirements should nonetheless be fulfilled during installation and operation.



Ü mark

Proof of compliance for European or nationally regulated construction products.



Quality mark for high-quality stainless steel

Stainless steel material 1.4301 or 1.4571 complies fully with the requirements for food-processing plants and guarantees perfect functional use.



Design awards

The **Red Dot Award** is an international design competition and is awarded in the categories Product design and Communication design. The **DobryDesign** award is bestowed by a Polish interior design magazine and honours particularly attractive products in various segments.



Polyethylene guarantee

KESSEL extends the warranty period for polyethylene tanks beyond the statutory requirement to 20 years. This covers the air-tightness, usability and static safety of these components.



Recyclat

These products are mainly manufactured from recycled material.



Recyclable

All KESSEL products are fully recyclable.

Integrated management system

Systematic sustainability

Alongside the strategic guidelines, the integrated management system for quality, energy, environment and occupational safety plays a central role at operative levels. The integrated management system serves to define measurable and realistic objectives for increasing sustainability in various areas and to implement these in a controlled manner.



Quality management system according to ISO 9001



Energy management system according to ISO 50001



Environmental management system according to ISO 14001



Occupational safety management system according to ISO 45001

A meaningful mission

The authority to issue instructions on all system-relevant issues lies with the management representatives, who report directly to the Executive Board and perform management functions within the sustainability team. They maintain the management systems, are available to all employees as direct points of contacts, are responsible for planning and conducting employee training and carry out internal and external audits.

The SWOT analysis...
 ...is a tool for strategic planning in companies. In a SWOT analysis, strengths, weaknesses, opportunities and threats within a specific business area are determined. Accordingly, "SWOT" stands for "Strengths, Weaknesses, Opportunities and Threats".

Controlled implementation

Through our management systems, we not only coordinate our target systems, but also monitor and control our internal processes. Our systems help us to anchor our sustainability strategy and the guiding principles contained within the company which ensures responsible business operations. To date, management systems have been implemented at the company headquarters and main production site in Lenting. Implementation at our international locations in Poland and China has already been planned. This will also be implemented there in accordance with the applicable standards, in order to achieve the best possible results and to be able to demonstrate sustainable corporate management transparently vis-à-vis third parties.

1. Backwater protection

Protection against flooding
due to backwater

Overview of Backwater protection range

1.1 Backwater valves



Backwater pumping station
Pumpfix F

➤ Page 26



Backwater valve
Staufix
Ø 110, 125, 160, 200

➤ Page 37



Backwater valve
Staufix FKA

➤ Page 31



Backwater valve
Staufix Basic
Ø 100, 110, 125, 160, 200

➤ Page 43



Backwater valve
Staufix SWA

➤ Page 33



Backwater valve
Staufix
Ø 50 or Ø 75

➤ Page 46



Clean out
Controlfix

➤ Page 35



Can be converted to:
Pumpfix F, Staufix FKA,
Staufix SWA



Backwater valve
Multitube
Ø 260, 320, 410, 515

➤ Page 48



Backwater valve
Pipe flap
Ø 110 - 1000

➤ Page 49





1.2 Backwater chambers for backwater valves



Backwater chamber
Standard backwater chamber
Ø 1000 with *Controlfix*

➤ Page 60



Can be converted to:
Pumpfix F, Staufix FKA,
Staufix SWA



Modular backwater chamber
Ø 1000 with *Controlfix*

➤ Page 61



Can be converted to:
Pumpfix F, Staufix FKA,
Staufix SWA

Type of wastewater



Wastewater containing sewage



Wastewater without sewage

Installation situation



Outdoor, underground installation



Indoor, exposed installation



Floor slab installation

Function



Protects in the event of backwater



Protects and disposes in the event of backwater

No slope to the sewage pipe?

➤ Lifting stations: page 106

➤ Pumping stations: page 142

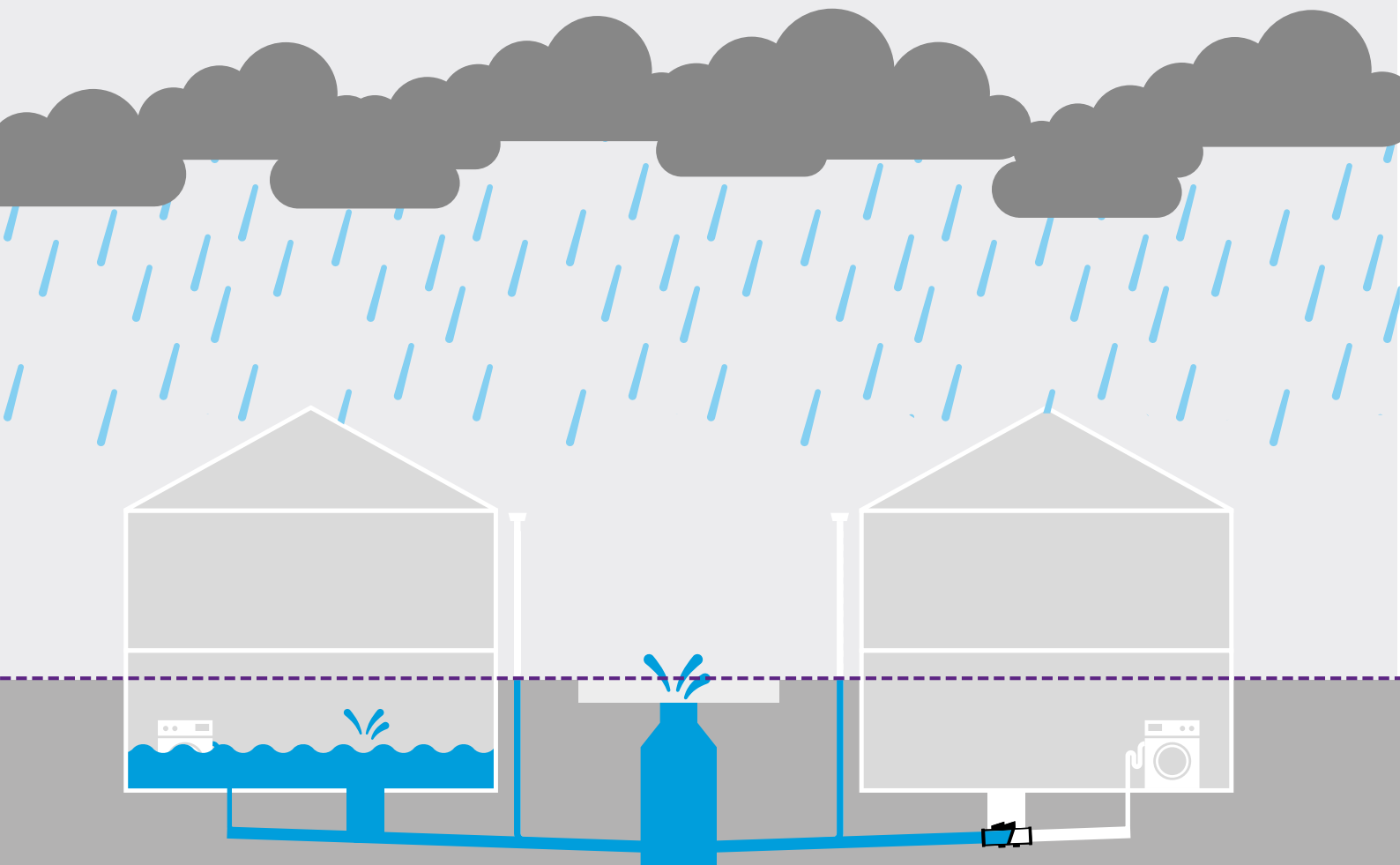
Additional KESSEL products with integrated backwater protection:

➤ Hybrid lifting stations: page 78

➤ Basement drains: page 280

Everything specialists need to know

What is backwater and what criteria must be noted for the correct product choice?



Water drainage system without backwater protection

During heavy rain, the water level rises above the so-called backwater level. This term is usually used to mean street level. Rooms in the basement or cellar quickly become flooded. The results are significant damage and costs.

Water drainage system with backwater protection

Wastewater that flows with a slope to the sewer will be protected by a backwater valve. In the event of backwater, the flap closes so that no wastewater can enter the building. If the public sewer is higher than the drainage spot in the building, the wastewater must be pumped above the backwater level, for example via an Aqualift lifting station from KESSEL.

KESSEL backwater valves according to EN 13564

With mechanical flap system

Staufix and *Staufix SWA* backwater valves are available with one or two vertically hanging flaps. Additionally they can be equipped with a flap locking lever.

Type 0 Backwater valve for use in horizontal pipes with one closure flap.

Type 1 Backwater valve for use in horizontal pipes with one self actuating closure flap equipped with locking lever.

Type 2 Backwater valve for use in horizontal pipes with two self actuating closure flaps one of which equipped with a locking lever.

Type 4 Floor drain with integrated self actuating closure flap equipped with locking lever.

Type 5 Floor drain with two integrated self actuating closure flaps one of which is equipped with a locking lever.



With electronic open flap system

The *Staufix FKA* has two open flaps. One closes electrically during backwater and additionally it has a back-up manually closable flap. This is the ideal product for use with raw sewage.

Type 3 Backwater valve for use in horizontal pipes with an automated closure flap operated by external energy (electric, pneumatic or other) and a second back-up manual closure flap.



With electronic open flap system and sewage pump

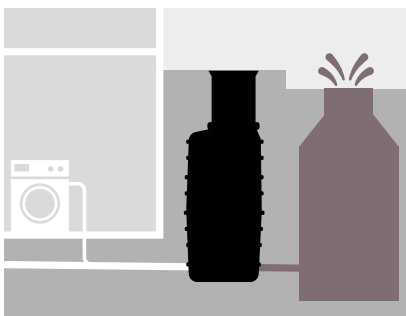
The flap of the *Pumpfix F* closes electrically and the integrated sewage pump discharges the building's wastewater into the sewer during backwater.

Type 3 Backwater valve for use in horizontal pipes with an automated closure flap operated by external energy (electric, pneumatic or other) and a second back-up manual closure flap.



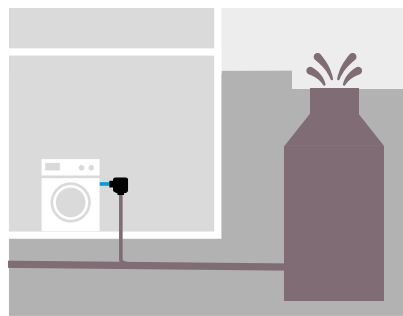
Installation situation

There are three options for installing backwater protection.



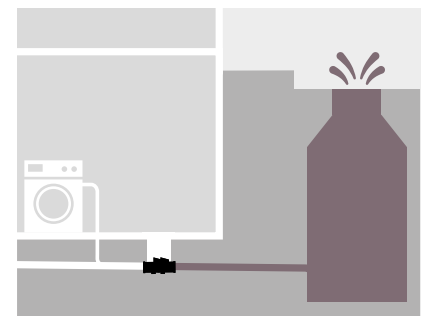
Outdoor, underground installation

This is the most practical solution. Products to protect against water ingress are installed in a chamber in the ground in front of the building. This saves space in the basement, noise nuisance can be practically ruled out and the installation is functionally secure and maintenance-friendly.



Exposed installation

This is the simplest solution as it does not require a great deal of structural rework. This means that the installation is quick and that the backwater protection unit is always easily accessible for maintenance and cleaning.



Floor slab installation

This is the most convenient solution. With floor slab installation, the backwater valve takes up no living space as it is unobtrusively installed in the underfloor. However, it is still accessible for maintenance or repair via the cover. Ideal for new construction.

Types of wastewater

In principle, we differentiate between two different types of wastewater. Different backwater protection devices can be considered depending on the type of wastewater being dealt with.



Wastewater with sewage

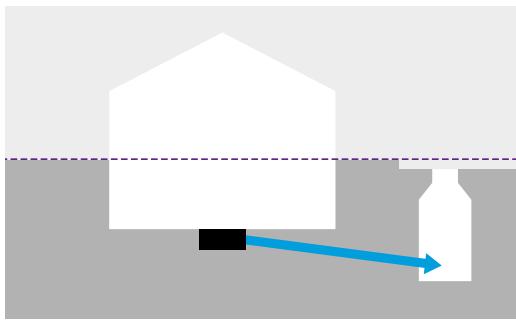
is water with faecal content coming from urinals or toilets to the sewer. This is termed "black water".



Wastewater without sewage

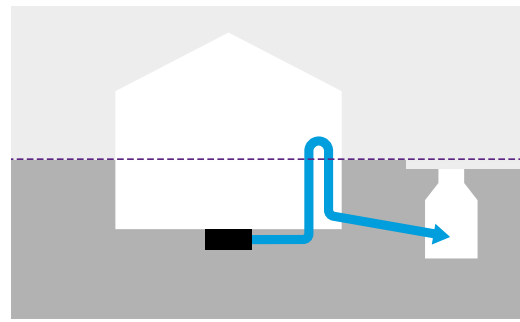
is water without faecal content, for example shower water or water from a washing machine. This is termed "grey water".

Slope to the public sewer



Slope to the public sewer

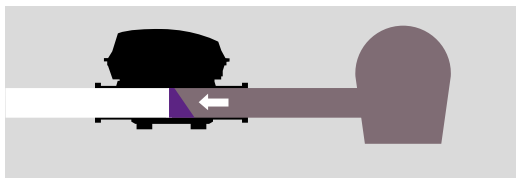
Backwater valves and hybrid lifting stations can be used here.



No slope to the public sewer

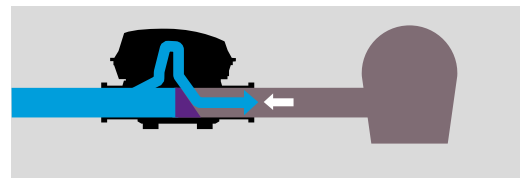
If the public sewer is higher than the basement level, the wastewater must be lifted to the sewage pipe with a lifting station via a backwater loop.

Function



Protects in the event of backwater

The backwater flap prevents wastewater from the public sewer from backing up through the drainage pipe and flooding the building.



Disposes in the event of backwater

Despite backwater from the public sewer and closed backwater flap(s), domestic wastewater can be disposed of via a pump. This ensures that the building's drainage system functions even in the event of backwater.

1.1 Backwater valves

Backwater flood protection





Backwater pumping station *Pumpfix F*

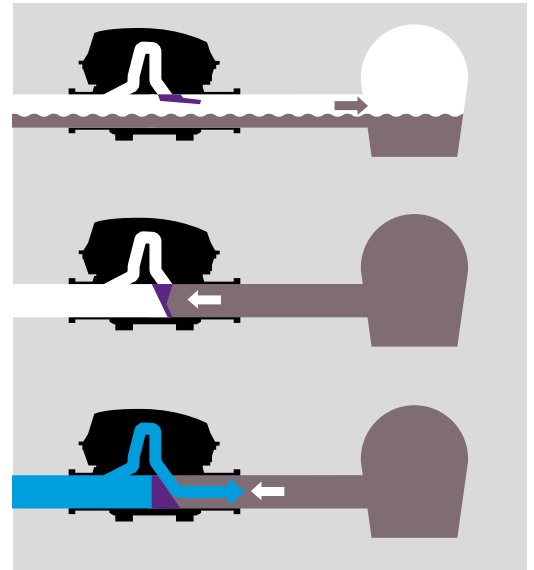
The unique backwater solution.

More than a backwater valve: *Pumpfix F* is the only backwater valve that pumps against backwater. In normal operation, the backwater pumping station continuously disposes of the wastewater via the slope to the main sewer, making it energy-neutral. In the event of backwater, the backwater flap closes automatically to protect the building from flooding and any wastewater from the building is pumped into the flooded sewer via the integrated sewage. The integrated cutting system shreds solids meaning the *Pumpfix F* can be used with wastewater containing sewage. It can also drain basement staircases up to 5 m².

Pumpfix F is available in two variants – for installation in an exposed drainage pipe and for floor slab installation, where you can choose between a black cover or tileable cover.

Application

For flats under the backwater level with no access to a toilet above backwater level.



How it works

Pumpfix F is the only backwater valve with hybrid function: In normal operation it uses the natural slope to the sewage pipe. In the event of backwater from the sewage pipe, the pump is automatically switched on in order to reliably pump the building's wastewater into the flooded sewer.



1 Backwater pumping station 2 Control unit 3 Sealing gasket set



1 Backwater pumping station 2 Control unit

Ventilation

Integrated ventilation eliminates the requirement for costly roof ventilation pipes

Motor

Automatically closes the backwater flap in the event of backwater

Body with only 9 mm integrated slope

Ideal for renovation work

Installation kit for the floor slab with integrated drainage function

The backwater valve is available for floor slab installation and can also be installed in waterproof concrete by using an extension piece with sealing flange and an elastomer waterproofing membrane. The integrated drainage function ensures that any surface water, for example due to a pipe break, will be pumped into the sewer even during times of backwater.



Flange for groundwater resistance available.

Optional with gasket set.

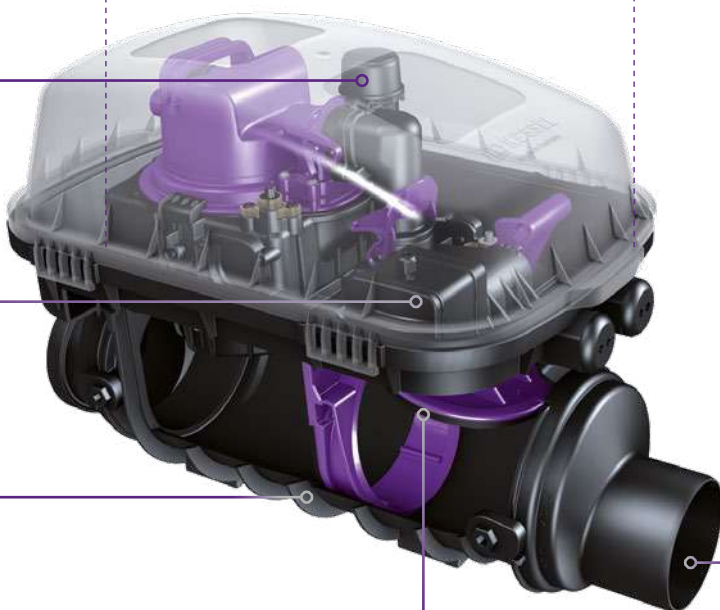
Comfort control unit

with multilingual (EN, DE, FR, IT, PL, NL) digital display for operating state and servicing instructions as well as connection option for building management system



Plug & Play control unit

with self-diagnosis system SDS for maximum safety



Motorized Flap

Closed backwater flap with integrated gasket provides secure and reliable protection during backwater

Removable inlet / outlet connections – also in Ø 200

- Flange/spigot for customized connections
- Variable inlet and outlet sizes available

Backwater pumping station *Pumpfix F*

Installation in a concrete slab / floor



Z-53.2-388

Made of polymer, with telescopic upper section for continuous height- and level adjustment. For installation depth (D) from 486 – 640 mm, Installation area 750 × 750 mm. With surface water tight polymer cover plate class A 15 and integrated floor drain.

Installation kit with choice of cover.

Backwater pumping station according to EN 13564 Type 3 with pump (1kW/230V) and backwater valve, pump activates during backwater, suitable for wastewater with or without sewage.

Plug-and-Play control unit with connection option to building management system and alarm, display for operating status and battery back-up, protection type IP 54, with integrated self diagnosis system SDS, motorized backwater flap, *Pumpfix F* body rated protection type IP 68 (3 m, 24 h).

Power cable length: 5 m (15 m available on request).

Accessories:

Extension sections for installation in waterproof concrete see page 54



Outer diameter Ø (mm)	L × H in mm	Art. no.
-----------------------	-------------	----------

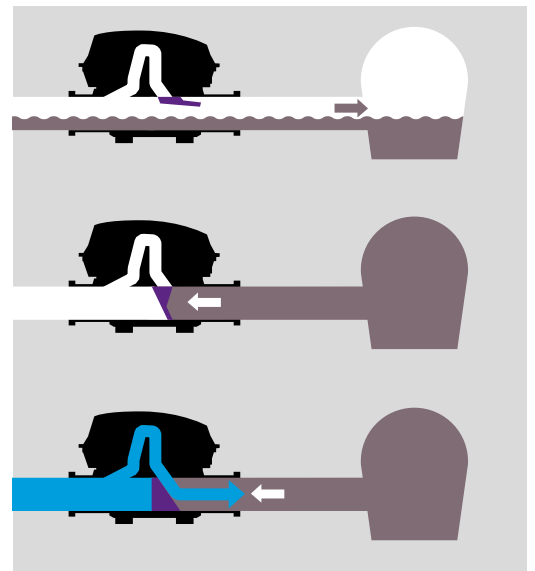
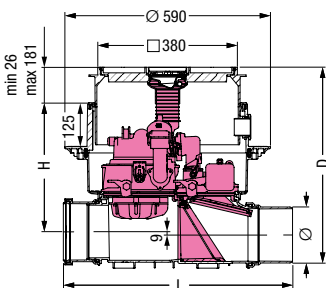
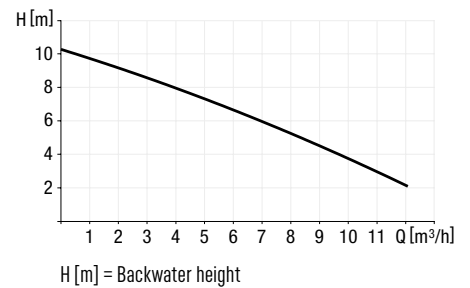
With recessed cover for on-site tiling with integrated drain

Ø 110	642 × 394	24 100X
Ø 125	645 × 387	24 125X
Ø 160	656 × 370	24 150X
Ø 200*	720 × 348	24 200X

With black cover with integrated drain

Ø 110	642 × 394	24 100S
Ø 125	645 × 387	24 125S
Ø 160	656 × 370	24 150S
Ø 200*	720 × 348	24 200S

Pumping capacity



How it works

Pumpfix F is the only backwater valve with hybrid function: In normal operation it uses the natural slope to the sewage pipe. In the event of backwater from the sewage pipe, the pump is automatically switched on in order to reliably pump the building's wastewater into the flooded sewer.

* In-/Outlet Ø 200, hydraulics corresponds to Ø 160



Backwater pumping station *Pumpfix F*

Installation in an exposed wastewater pipe



Z-53.2-388

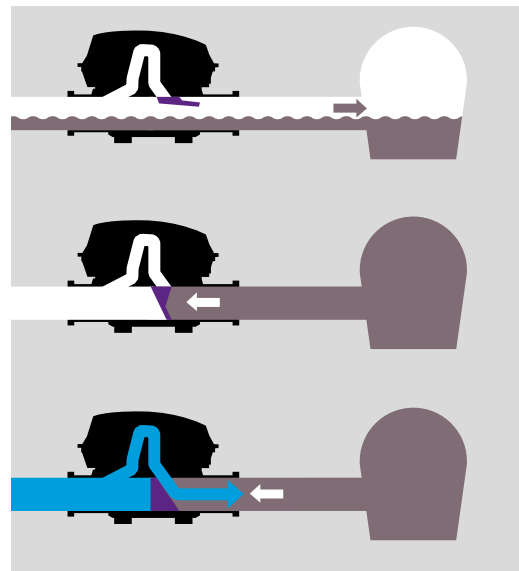
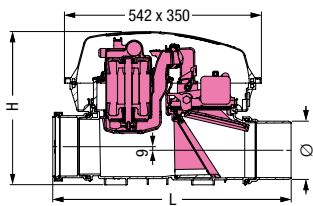
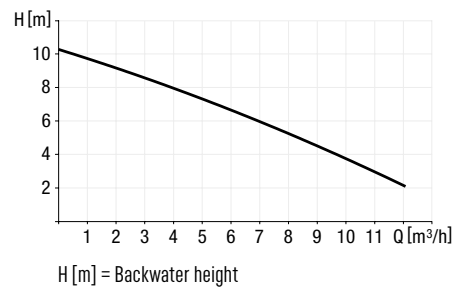
Made of polymer, with protective cover. Backwater pumping station according to EN 13564 Type 3 with pump (1kW/230V) and backwater valve, pump activates during backwater, suitable for wastewater with or without sewage. Plug-and-Play control unit with connection option to building management system and alarm, display for operating status and battery back-up, protection type IP 54, with integrated self diagnosis system SDS, motorized backwater flap, *Pumpfix F* body rated protection type IP 68 (3 m, 24 h).

Power cable length: 5 m (15 m available on request).



Outer diameter Ø (mm)	L × H in mm	Art. no.
Ø 110	642 × 422	24 100
Ø 125	645 × 422	24 125
Ø 160	656 × 422	24 150
Ø 200*	720 × 422	24 200

Pumping capacity



How it works

Pumpfix F is the only backwater valve with hybrid function: In normal operation it uses the natural slope to the sewage pipe. In the event of backwater from the sewage pipe, the pump is automatically switched on in order to reliably pump the building's wastewater into the flooded sewer.

* In-/Outlet Ø 200, hydraulics corresponds to Ø 160



Backwater valves

Staufix FKA

The reliable solution for wastewater with sewage.

Particularly reliable motor operation: In contrast to conventional backwater valves, the *Staufix FKA* closes the backwater flap with the help of a motor. This means that it is also suitable for wastewater containing sewage – not only for showers, washbasins and washing machines, but also for toilets.

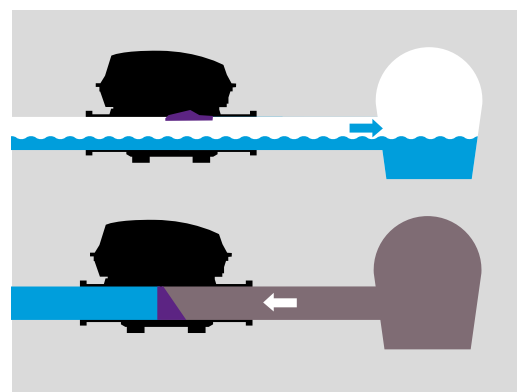
Staufix FKA is available in two variants – for installation in an exposed drainage pipe and for floor slab installation, where you can choose between a black cover or tileable cover.



1 Backwater valve 2 Control unit



1 Backwater valve 2 Control unit 3 Sealing gasket set



How it works

During normal operations, both flaps are open so that all the wastewater can drain away fully. In the event of backwater from the sewer, the flap is closed and locked by a motor and then opened again automatically afterwards.

Installation kit for the floor slab

The backwater valve is available for floor slab installation with a tileable cover and can also be installed in waterproof concrete by using an extension piece with central flange and an elastomer waterproofing membrane.

The backwater valve has a plug-in, fully wired, convenient control unit with SDS self-diagnosis system.

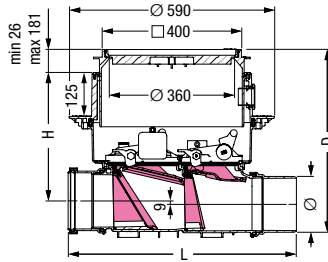
Backwater valve *Staufix FKA*

Installation in a concrete slab / floor



CE EN 13564 Type 3 F

Made of polymer, with telescopic upper section for continuous height- and level adjustment. For installation depth (D) from 486 – 640 mm, Installation area 750 × 750 mm With surface water tight cover plate class A 15 made of polymer. Installation kit with choice of cover. Backwater valve according to EN 13564 Type 3 with two open flaps. Plug-and-Play control unit with connection option to building management system and alarm, protection type IP 54, with integrated self diagnosis system SDS, display for operating status and battery back-up, motor is rated protection Type IP 68 (3 m, 24 h). Supply voltage/-frequency: 230 V AC/50 Hz. **Power cable length:** 5 m (15 m available on request).



Accessories:

- Extension sections for installation in waterproof concrete see page 54
- Conversion kits see page 35



Outer diameter Ø (mm)	L × H in mm	Art. no.
-----------------------	-------------	----------

With recessed cover for on-site tiling

Ø 110	642 × 394	84 100X
Ø 125	645 × 387	84 125X
Ø 160	656 × 370	84 150X
Ø 200*	720 × 348	84 200X

With black cover

Ø 110	642 × 394	84 100S
Ø 125	645 × 387	84 125S
Ø 160	656 × 370	84 150S
Ø 200*	720 × 348	84 200S

* In-/Outlet Ø 200, hydraulics corresponds to Ø 160

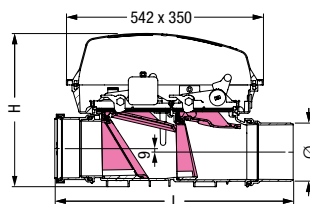
Backwater valve *Staufix FKA*

Installation in an exposed wastewater pipe



CE EN 13564 Type 3 F

Made of polymer, with protective cover. Backwater valve according to EN 13564 Type 3 with two open flaps. Plug-and-Play control unit with connection option to building management system and alarm, display for operating status and battery back-up, protection type IP 54, with integrated self diagnosis system SDS, display for operating status and battery back-up, motor is rated protection Type IP 68 (3 m, 24 h). Supply voltage/-frequency: 230 V AC/50 Hz. **Power cable length:** 5 m (15 m available on request).



Accessories: Conversion kits see page 35



Outer diameter Ø (mm)	L × H in mm	Art. no.
-----------------------	-------------	----------

Ø 110	642 × 422	84 100
Ø 125	645 × 422	84 125
Ø 160	656 × 422	84 150
Ø 200*	720 × 422	84 200

* In-/Outlet Ø 200, hydraulics corresponds to Ø 160

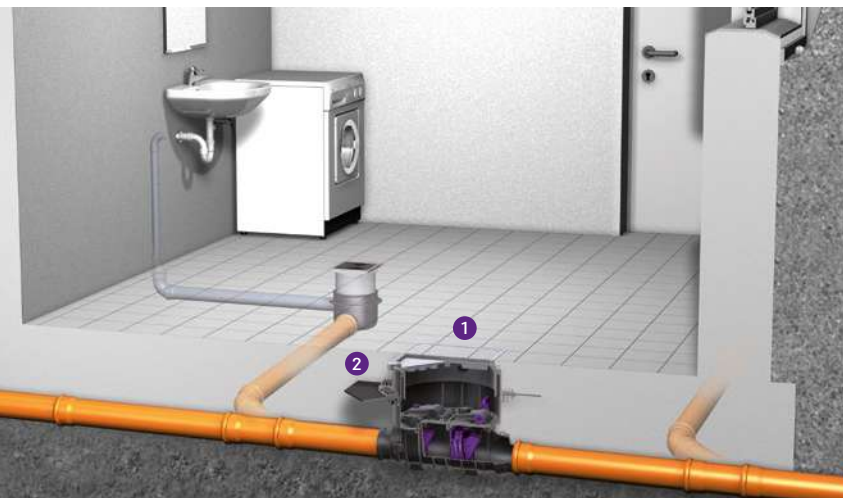
Backwater valves

Staufix SWA

The reliable solution for wastewater

Double security with two pendulum flaps: The *Staufix SWA* backwater valve for wastewater offers absolute security in protection against backwater. In the event of backwater, the outer flap closes with the second flap providing additional security. The system can also be locked with a manually actuated emergency closure. *Staufix SWA* is suitable for showers, washbasins and washing machines.

Staufix SWA is available in two versions – for installation in an exposed drainage pipe and for floor slab installation, where you can choose between a black cover or tileable cover.



1 Backwater valve 2 Sealing gasket set



1 Backwater valve

Simple conversion

The *Staufix SWA* backwater valve can be retrofitted with the *Staufix FKA* and *Pumpfix F* conversion kits – even in its installed state.

- **Backwater valve *Staufix FKA***
Page 31
- **Backwater pumping station *Pumpfix F***
Page 28
- **Conversion kits**
Page 35

Twin flap backwater valve *Staufix SWA*

Installation in a concrete slab / floor



CE EN 13564 Type 2

Made of polymer, with telescopic upper section for continuous height- and level adjustment. For installation depth (D) from 486 – 640 mm, Installation area 750 × 750 mm With surface water tight cover plate class A 15 made of polymer.

Installation kit with choice of cover.

Backwater valve according to EN 13564 Type 2 with two self-closing flaps, one of which can be locked by hand as an emergency closure.

➤ Accessories:

- Extension sections for installation in waterproof concrete see page 54
- Conversion kits see page 35



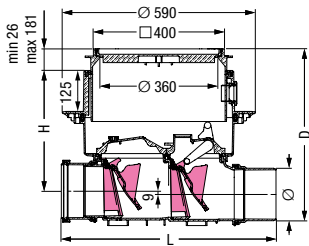
**Outer diameter
Ø (mm)** **L × H in mm** **Art. no.**

With recessed cover for on-site tiling

Ø 110	642 × 394	73 100.10X
Ø 125	645 × 387	73 125.10X
Ø 160	656 × 370	73 150.10X
Ø 200*	720 × 348	73 200.10X

With black cover

Ø 110	642 × 394	73 100.10S
Ø 125	645 × 387	73 125.10S
Ø 160	656 × 370	73 150.10S
Ø 200*	720 × 348	73 200.10S



* In-/Outlet Ø 200, hydraulics corresponds to Ø 160

Twin flap backwater valve *Staufix SWA*

Installation in an exposed wastewater pipe



CE EN 13564 Type 2

Made of polymer, with protective cover.

Backwater valve according to EN 13564 Type 2 with two self-closing flaps, one of which can be locked by hand as an emergency closure.

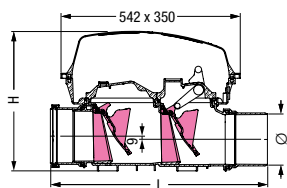
➤ Accessories:

Conversion kits see page 35



**Outer diameter
Ø (mm)** **L × H in mm** **Art. no.**

Ø 110	642 × 422	73 100.10
Ø 125	645 × 422	73 125.10
Ø 160	656 × 422	73 150.10
Ø 200*	720 × 422	73 200.10



* In-/Outlet Ø 200, hydraulics corresponds to Ø 160

Clean out *Controlfix*

The practical upgrade solution.

The foundation stone for your safety: Clean outs are installed at regular intervals in the drainage pipes in order to be able to clear out any blockages more easily. Our clean out *Controlfix* also facilitates this task further with its practical quick-release closures, enabling you to carry out maintenance quickly and without the need for tools.

Would you like to retain the option to retrospectively equip your drainage pipe with a backwater valve? The *Controlfix* clean out is ideally suited for this too – as it can be easily upgraded in situ to a *Staufix* backwater valve or a *Pumpfix F* backwater pumping station!

Clean out *Controlfix*

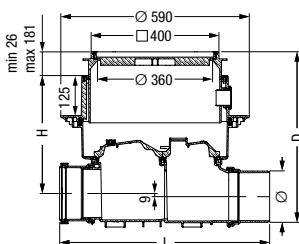
Installation in a concrete slab / floor

Made of polymer, with telescopic upper section for continuous height- and level adjustment. For installation depth (D) from 486 – 640 mm, Installation area 750 × 750 mm. With surface water tight cover plate class A 15 made of polymer.

Installation kit with choice of cover.

➤ Accessories:

- Extension sections for installation in waterproof concrete see page 54
- Conversion kits see page 35



Outer diameter Ø (mm)	L × H in mm	Art. no.
With recessed cover for on-site tiling		
Ø 110	642 × 394	80 100X
Ø 125	645 × 387	80 125X
Ø 160	656 × 370	80 150X
Ø 200*	720 × 348	80 200X

Outer diameter Ø (mm)	L × H in mm	Art. no.
With black cover		
Ø 110	642 × 394	80 100S
Ø 125	645 × 387	80 125S
Ø 160	656 × 370	80 150S
Ø 200*	720 × 348	80 200S

* In-/Outlet Ø 200, hydraulics corresponds to Ø 160

Clean out *Controlfix*

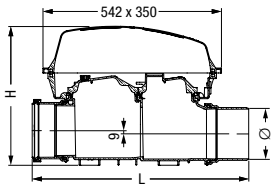
Installation in an exposed wastewater pipe



Made of polymer, with protective cover.

Accessories:

Conversion kits see below







Outer diameter Ø (mm)	L × H in mm	Art. no.
Ø 110	642 × 422	80 100
Ø 125	645 × 422	80 125
Ø 160	656 × 422	80 150
Ø 200*	720 × 422	80 200

* In-/Outlet Ø 200, hydraulics corresponds to Ø 160

Conversion kits

for *Pumpfix F*, *Staufix FKA* and *Staufix SWA* models made on or after Jan 2011

		Art. no.
Backwater pumping <i>Pumpfix F</i> for installation in a concrete slab/floor	Compatibility: For Ø 110 – Ø 200* Inclusive: Comfort control unit with recessed cover for on-site tiling and drain, <i>Multistop</i> , gasket Cable length: 5 m ↗ Cable extension: See page 54	 80 098
Backwater pumping <i>Pumpfix F</i> for installation in an exposed wastewater pipe	Compatibility: For Ø 110 – Ø 200* Inclusive: Comfort control unit Cable length: 5 m ↗ Cable extension: See page 54	 80 097
Motorized backwater valve <i>Staufix FKA</i>	Compatibility: For installation in a concrete slab/floor and in an exposed wastewater pipe, for Ø 110 – Ø 200* Inclusive: Comfort control unit Cable length: 5 m ↗ Cable extension: See page 54	 80 093
Backwater valve <i>Staufix SWA</i>	Compatibility: For installation in a concrete slab/floor and in an exposed wastewater pipe, for Ø 110 – Ø 200* * In-/Outlet Ø 200, hydraulics corresponds to Ø 160	 80 091

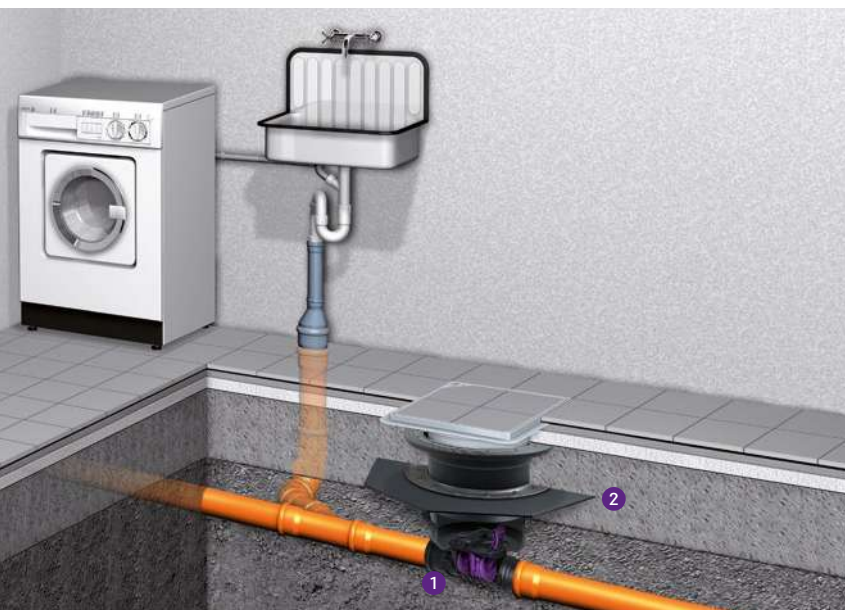
Backwater valves

Staufix

The original solution for wastewater without sewage.

You can't improve on an original... But we can! The new *Staufix* is the result of decades of product development and optimisation. It is now even more compact, allowing a simpler installation and more flexible mounting.

Staufix is each available in two variants – for installation in an exposed drainage pipe and for floor slab installation, where you can choose between a black cover or tileable cover.



1 Backwater valve 2 Extension section

Flexibly installable

The new installation kit is available with three different extension sections and can therefore be installed flexibly at depths of up to 65 cm. Choose from a standard extension section, an extension section with flange, and mating flange made of stainless steel as well as with elastomer waterproofing membrane for deeper installation in waterproof concrete.

Individually combinable

The sockets and spigots are available in the same or in different nominal inlet and outlet sizes – and can be individually combined with different drain bodies. The interchangeable sockets therefore flexibly fit on all standard pipes. This is especially practical if old and new pipes have to be joined in case of structural alterations or renovation work.

Installation situation

The backwater valves *Staufix* can be installed either in an exposed drainage pipe or in the floor slab – convenient and tidy thanks to the installation kit with telescopic upper section. Even installation in waterproof concrete is possible by means of an extension piece with flange and an elastomer waterproofing membrane.



Individually combinable

The sockets and spigots are available with the same sizes or different inlet and outlet sizes – and can be individually combined with two different pipe sizes. The two-way sockets thus fit flexibly on all pipes. This is especially practical if old pipes have to be joined to new pipes for structural alteration or renovation work.

Tool-free maintenance

With the quick-fastening, single-hand closure system with lift function, the cover is particularly easy to open and close – for convenient maintenance, with absolutely no tools required.

Twin flap backwater valve *Staufix*

Installation in a concrete slab / floor



EN 13564 Type 2

Made of polymer, with telescopic upper section for continuous height- and level adjustment.

For installation depth (D)

Ø 90 – 110, 276 – 399 mm

Ø 125 – 200, 328 – 450 mm,

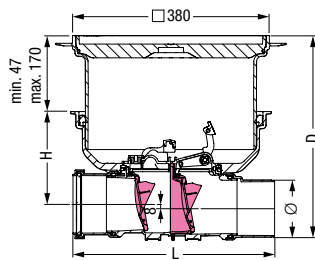
Installation area 750 × 750 mm

With surface water tight cover plate class A 15 made of polymer.

Installation kit with choice of cover.

Backwater valve according to EN 13564 Type 2 with two self-closing flaps, one of which can be locked by hand as an emergency closure.

➤ **Accessories:** see page 54 – 57



Without rodent protection (two polymer flaps)

Outer diameter Ø (mm)	L × H in mm	Art. no.
With recessed cover for on-site tiling		
Ø 90	389 × 179	730 090.10X
Ø 110	389 × 179	730 100.10X
Ø 125	515 × 222	730 125.10X
Ø 160	526 × 205	730 150.10X
Ø 200*	590 × 185	730 200.10X

With black cover

Ø 90	389 × 179	730 090.10S
Ø 110	389 × 179	730 100.10S
Ø 125	515 × 222	730 125.10S
Ø 160	526 × 205	730 150.10S
Ø 200*	590 × 185	730 200.10S

With rodent protection (one polymer and one stainless steel flap)

Outer diameter Ø (mm)	L × H in mm	Art. no.
With recessed cover for on-site tiling		
Ø 90	389 × 179	730 090.10XR
Ø 110	389 × 179	730 100.10XR
Ø 125	515 × 222	730 125.10XR
Ø 160	526 × 205	730 150.10XR
Ø 200*	590 × 185	730 200.10XR

With black cover

Ø 90	389 × 179	730 090.10SR
Ø 110	389 × 179	730 100.10SR
Ø 125	515 × 222	730 125.10SR
Ø 160	526 × 205	730 150.10SR
Ø 200*	590 × 185	730 200.10SR



* In-/Outlet Ø 200, hydraulics corresponds to Ø 160

Twin flap backwater valve *Staufix*

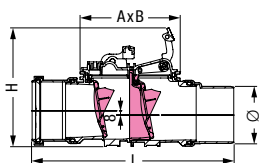
Installation in an exposed wastewater pipe



EN 13564 Type 2

Made of polymer. Backwater valve according to EN 13564 Type 2 with two self-closing flaps, one of which can be locked by hand as an emergency closure.

Accessories: see page 54 – 57



Without rodent protection (two polymer flaps)

Outer diameter Ø (mm)	L × H in mm	A × B in mm	Art. no.
Ø 90	386 × 230	193 × 167	730 090
Ø 110	389 × 230	193 × 167	730 100
Ø 125	515 × 306	263 × 214	730 125
Ø 160	526 × 306	263 × 214	730 150
Ø 200*	590 × 306	263 × 214	730 200

With rodent protection (one polymer and one stainless steel flap)

Outer diameter Ø (mm)	L × H in mm	A × B in mm	Art. no.
Ø 90	386 × 230	193 × 167	730 090R
Ø 110	389 × 230	193 × 167	730 100R
Ø 125	515 × 306	263 × 214	730 125R
Ø 160	526 × 306	263 × 214	730 150R
Ø 200*	590 × 306	263 × 214	730 200R

1.1



* In-/Outlet Ø 200, hydraulics corresponds to Ø 160

Single flap backwater valve *Staufix*

Installation in a concrete slab / floor



EN 13564 Type 1

Made of polymer, with telescopic upper section for continuous height- and level adjustment.

For installation depth (D)

Ø 90 – 110, 276 – 399 mm

Ø 125 – 200, 328 – 450 mm,

Installation area 750 × 750 mm

With surface water tight cover plate class A 15 made of polymer.

Installation kit with choice of cover.

Backwater valve according to EN 13564 Type 1

with one self-closing flap, can be locked by hand as an emergency closure.

Note: Can be upgraded to *Staufix* Type 2.

➤ **Accessories:** see page 54 – 57



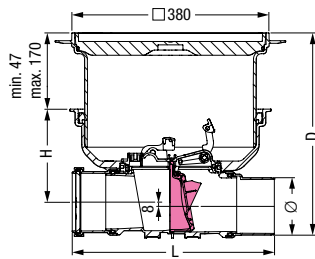
Outer diameter Ø (mm)	L × H in mm	Art. no.
--------------------------	-------------	----------

With recessed cover for on-site tiling

Ø 90	389 × 179	720 090.10X
Ø 110	389 × 179	720 100.10X
Ø 125	515 × 222	720 125.10X
Ø 160	526 × 205	720 150.10X
Ø 200*	590 × 185	720 200.10X

With black cover

Ø 90	389 × 179	720 090.10S
Ø 110	389 × 179	720 100.10S
Ø 125	515 × 222	720 125.10S
Ø 160	526 × 205	720 150.10S
Ø 200*	590 × 185	720 200.10S



* In-/Outlet Ø 200, hydraulics corresponds to Ø 160

Single flap backwater valve *Staufix*

Installation in an exposed wastewater pipe



EN 13564 Type 1

Made of polymer

Backwater valve according to EN 13564 Type 1

with one self-closing flap, can be locked by hand as an emergency closure.

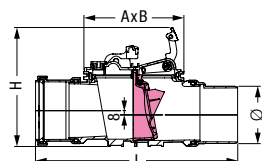
Note: Can be upgraded to *Staufix* Type 2.

➤ **Accessories:** see page 54 – 57



Outer diameter Ø (mm)	L × H in mm	A × B in mm	Art. no.
--------------------------	-------------	-------------	----------

Ø 90	386 × 230	193 × 167	720 090
Ø 110	389 × 230	193 × 167	720 100
Ø 125	515 × 306	263 × 214	720 125
Ø 160	526 × 306	263 × 214	720 150
Ø 200*	590 × 306	263 × 214	720 200



* In-/Outlet Ø 200, hydraulics corresponds to Ø 160

Clean out *Staufix*

Installation in a concrete slab / floor



Made of polymer, with telescopic upper section for continuous height- and level adjustment.

For installation depth (D)

Ø 90 – 110, 276 – 399 mm

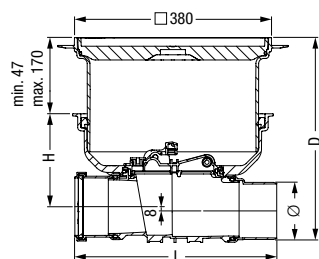
Ø 125 – 200, 328 – 450 mm,

Installation area 750 × 750 mm

With surface water tight cover plate class A 15 made of polymer.

Installation kit with choice of cover.

➤ **Accessories:** see page 54 – 57



Outer diameter Ø (mm)	L × H in mm	Art. no.
--------------------------	-------------	----------

With recessed cover for on-site tiling

Ø 90	389 × 179	700 090.10X
Ø 110	389 × 179	700 100.10X
Ø 125	515 × 222	700 125.10X
Ø 160	526 × 205	700 150.10X
Ø 200*	590 × 185	700 200.10X

With black cover

Ø 90	389 × 179	700 090.10S
Ø 110	389 × 179	700 100.10S
Ø 125	515 × 222	700 125.10S
Ø 160	526 × 205	700 150.10S
Ø 200*	590 × 185	700 200.10S

* In-/Outlet Ø 200, hydraulics corresponds to Ø 160

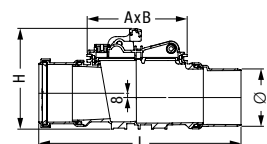
Clean out *Staufix*

Installation in an exposed wastewater pipe



Made of polymer

➤ **Accessories:** see page 54 – 57



Outer diameter Ø (mm)	L × H in mm	A × B in mm	Art. no.
--------------------------	----------------	----------------	----------

Ø 90	386 × 230	193 × 167	700 090
Ø 110	389 × 230	193 × 167	700 100
Ø 125	515 × 306	263 × 214	700 125
Ø 160	526 × 306	263 × 214	700 150
Ø 200*	590 × 306	263 × 214	700 200

* In-/Outlet Ø 200, hydraulics corresponds to Ø 160

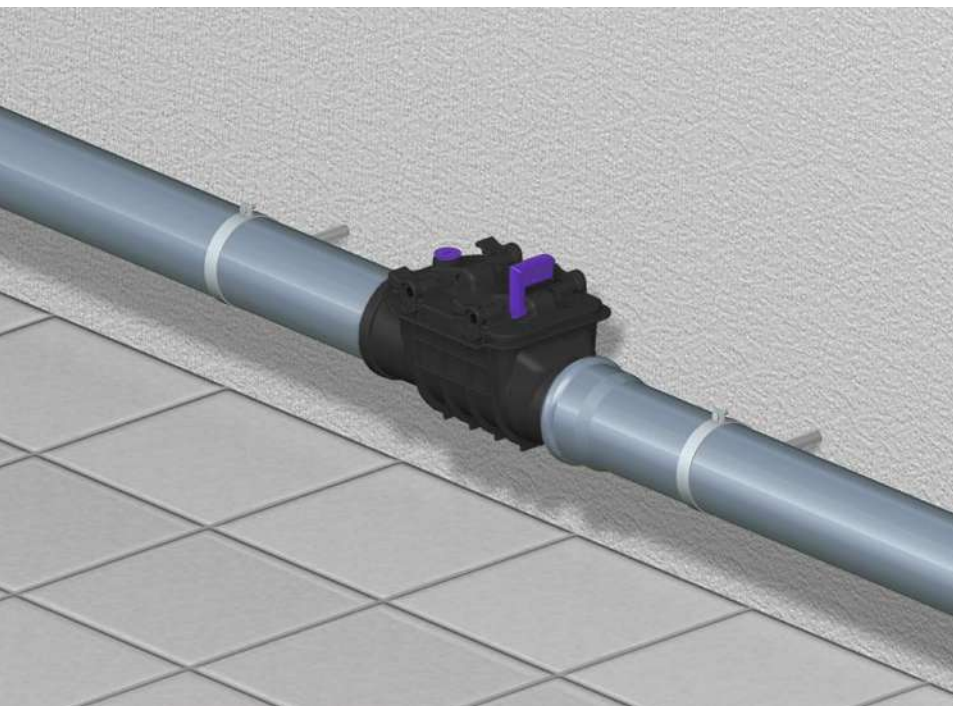


Backwater valves

Staufix Basic

The original solution for dry basements.

The original backwater valve *Staufix Basic* has been the standard in the water drainage sector for over 40 years. It is made entirely of polymer and so is completely corrosion-free. The *Staufix Basic* is installed in an individual drainage pipe and prevents the penetration of water and rodents by means of mechanical flaps – simple and secure!



Low drop

Thanks to the minimal height difference of just 7 mm between the inlet and outlet, the backwater valve is ideally suited to installation in existing drainage pipes.

Cleaning & maintenance without tools

The cover can be opened or locked by hand thus providing access without the need for tools.

Rat protection

The optional stainless steel rat protection flap prevents rats and other vermin entering the premises.

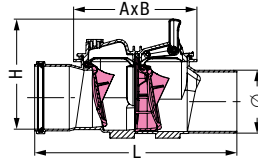
Twin flap backwater valve *Staufix Basic*

Installation in an exposed wastewater pipe



EN 13564 Type 2

Made of polymer. Installation area 650 × 300 mm. Twin flaps, self-closing, one of which can be locked by hand as an emergency closure. Inlet/outlet for connection to PVC pipe according to EN 1566-1.



Without rodent protection
(two polymer flaps)

Outer diameter Ø (mm)	L × H in mm	A × B in mm	Art. no.
Ø 110	355 × 180+25	205 × 155	73 100
Ø 125	405 × 240+40	270 × 200	73 125
Ø 160	450 × 240+40	270 × 200	73 150
Ø 200	530 × 278+50	353 × 248	73 200

With rodent protection
(one polymer and one stainless steel flap)

Outer diameter Ø (mm)	L × H in mm	A × B in mm	Art. no.
Ø 110	355 × 180+25	205 × 155	73 100R
Ø 125	405 × 240+40	270 × 200	73 125R
Ø 160	450 × 240+40	270 × 200	73 150R



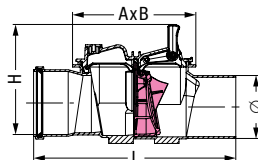
Single flap backwater valve *Staufix Basic*

Installation in an exposed wastewater pipe



EN 13564 Type 1

Made of polymer. Installation area 650 × 300 mm. Self-closing flap, can be locked by hand as an emergency closure. Inlet/outlet for connection to PVC pipe according to EN 1566-1.



Without rodent protection
(one polymer flap)

Outer diameter Ø (mm)	L × H in mm	A × B in mm	Art. no.
Ø 100	355 × 180+25	205 × 155	77 100
Ø 110	355 × 180+25	205 × 155	72 100
Ø 125	405 × 240+40	270 × 200	72 125
Ø 160	450 × 240+40	270 × 200	72 150
Ø 200	530 × 278+50	353 × 248	72 200

With rodent protection
(one stainless steel flap)

Outer diameter Ø (mm)	L × H in mm	A × B in mm	Art. no.
Ø 110	355 × 180+25	205 × 155	72 100R
Ø 125	405 × 240+40	270 × 200	72 125R
Ø 160	450 × 240+40	270 × 200	72 150R



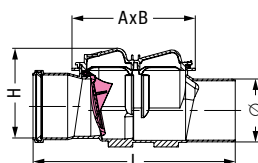
Single flap backwater valve *Staufix Basic*

Installation in an exposed wastewater pipe



EN 13564 Type 0

Made of polymer. Installation area 650 × 300 mm, Self-closing flap. Inlet/outlet for connection to PVC pipe according to EN 1566-1.



Outer diameter Ø (mm)	L × H in mm	A × B in mm	Art. no.
Ø 100	355 × 170	205 × 155	76 100
Ø 110	355 × 170	205 × 155	71 100
Ø 125	405 × 230	270 × 200	71 125
Ø 160	450 × 230	270 × 200	71 150
Ø 200	530 × 278	353 × 248	71 200

↗ Conversion kits: page 44
↗ Accessories: pages 54 – 57



Clean out *Staufix Basic*

Installation in an exposed wastewater pipe



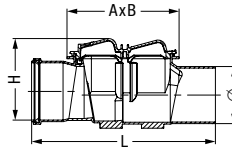
Made of polymer.

Installation area 650×300 mm

Upgradable to all *Staufix* model backwater valves

➤ **Conversion kits:** see below




➤ **Accessories:** pages 54 – 57



Outer diameter Ø (mm)	L × H in mm	A × B in mm	Art. no.
Ø 110	355 × 170	205 × 155	70 100
Ø 125	405 × 230	270 × 200	70 125
Ø 160	450 × 230	270 × 200	70 150
Ø 200	530 × 278	353 × 248	70 200

Conversion kits

for *Staufix Basic* from 04/2005

			Outer diameter Ø (mm)	Art. no.
for upgrade to Type 2 (Twin flap backwater valve <i>Staufix</i>) Function: The <i>Staufix Basic</i> clean out body can be converted to a <i>Staufix Basic</i> twin flap backwater valve by means of two backwater flaps, the insert flap housing and the lockable cover. Please note: 2x backwater flap 70 205 and the lockable cover are required for the Ø 200 version.	Backwater flap		Ø 110	70 231
			Ø 125	70 232
			Ø 160	70 232
			Ø 200	70 205
			Insert flap housing	
Ø 125	70 242			
Ø 160	70 242			
Ø 200	70 205			
for upgrade to Type 1 (Single flap backwater valve <i>Staufix</i>) Function: The <i>Staufix Basic</i> clean out body can be converted to a <i>Staufix Basic</i> single flap backwater valve with emergency closure by means of the backwater flap, insert flap housing and the lockable cover.	Lockable cover incl. emergency closure and sealing gasket		Ø 110	70 261
			Ø 125	70 262
			Ø 160	70 262
			Ø 200	70 203
for upgrade to Type 0 (Single flap backwater valve <i>Staufix</i>) Function: The <i>Staufix Basic</i> clean out body can be converted to a <i>Staufix Basic</i> single flap backwater valve by means of a backwater flap (for <i>Staufix Basic</i> from 04/2005).				

Backwater valve

Staufix Ø 50 or Ø 75

Standard-compliant in nominal widths
Ø 50 or Ø 75.

Individual drainage points such as washbasins, showers or washing machines can be very simply protected against backwater with the *Staufix* Ø 50 or *Staufix* Ø 75 backwater valves.

The *Staufix* Ø 50 or Ø 75 can be installed in the pipe to protect several drainage points. There are also additional variants of the *Staufix* Ø 50 with siphon traps, with washing machine connections or with inlet funnel for the emergency overflow of heating systems. This ensures that individual drainage points are protected.



Ø 50 or Ø 75 exposed drainage pipe



Washbasins with odour traps and washing machine connection



Twin flap backwater valve with inlet funnel for emergency overflow of heating system

Standard-compliant

The small backwater valves *Staufix* Ø 50 and *Staufix* Ø 75 are each equipped with two flaps and an emergency closure – and the first standard-compliant backwater double valves for wastewater without sewage per EN 13564 Type 2.

Area of application

The backwater valves are versatile in use: They can be installed as individual safeguards for washbasins, showers or washing machines, as a central backwater protection in horizontal drainage pipes or as an emergency overflow for heating systems.

Tool-free maintenance

The maintenance and cleaning of the backwater valves is particularly convenient and possible without any tools whatsoever thanks to the quick-release closure.

Twin flap backwater valve *Staufix* Ø 50

Installation in an exposed wastewater pipe

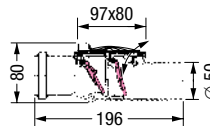


CE EN 13564 Type 2

Made of polymer.

Twin flaps, self-closing, one of which can be locked by hand as an emergency closure.

Inlet/outlet for connection to HT-pipe according to EN 1451-1.



Outer diameter Ø (mm)	Art. no.
Ø 50	73 050



Twin flap backwater valve *Staufix* Ø 75

Installation in an exposed wastewater pipe

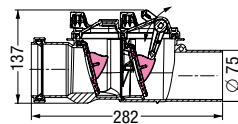


CE EN 13564 Type 2

Made of polymer.

Twin flaps, self-closing, one of which can be locked by hand as an emergency closure.

Inlet/outlet for connection to HT-pipe according to EN 1451-1.



Outer diameter Ø (mm)	Art. no.
Ø 75	73 070



Twin flap backwater valve *Staufix Siphon* Ø 50

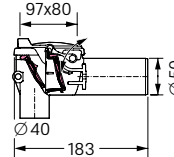
Installation in an exposed wastewater pipe



CE EN 13564 Type 5

Made of polymer.

Twin flaps, self-closing, one of which can be locked by hand as an emergency closure, incl. wall attachment, inlet connection Ø 40 (1 1/2 inch) at pipe odour trap. Outlet Ø 50 for connection to HT-pipe according to EN 1451-1.



Outer diameter Ø (mm)	Art. no.
Ø 50	73 051

Twin flap backwater valve *Staufix Siphon* Ø 50

Installation in an exposed wastewater pipe



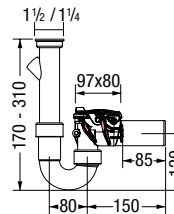
CE EN 13564 Type 5

Made of polymer.

Twin flaps, self-closing, one of which can be locked by hand as an emergency closure, incl. wall attachment, outlet Ø 50 for connection to HT-pipe according to EN 1451-1.

Model contains:

- pipe odour trap
- washing machine connection



Outer diameter Ø (mm)	Art. no.
Ø 50	73 052

Twin flap backwater valve *Staufix Siphon* Ø 50

Installation in an exposed wastewater pipe



CE EN 13564 Type 5

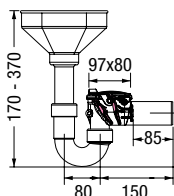
Made of polymer.

Two flaps, self-closing, one of which can be locked by hand as an emergency closure, incl. wall attachment. Outlet Ø 50 for connection to an HT-pipe according to EN 1451-1.

Model contains:

- pipe odour trap
- inlet funnel

Installation: Ideal for the emergency overflow of heating systems



Outer diameter Ø (mm)	Art. no.
Ø 50	73 053



Backwater valve *Multitube*

The high-performance solution for larger pipes.

The *Multitube* is a powerful backwater valve for large-diameter pipes in public, municipal and industrial areas. It can be installed in an exposed drainage pipe. The *Multitube* is also completely corrosion free as it is made entirely from polymer. Available in diameters of Ø 260 mm to Ø 515 mm.

Area of application

The *Multitube* backwater valve is suitable for use in leaching and pond systems and behind cisterns that are separately connected to a rainwater channel or that lead to a drainage ditch. It provides not only reliable protection against backwater, but also provides additional protection against rats, mice, frogs and vermin.



Single flap backwater valve *Multitube*

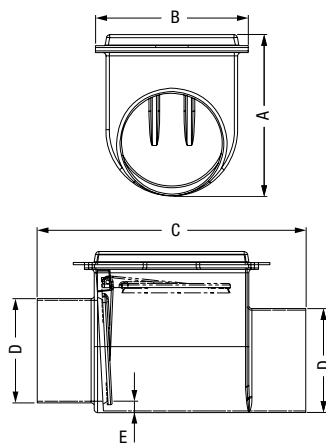
Installation in an exposed wastewater pipe



Made of polymer,
One self-closing flap,
incl. two connection couplings



Illustration shows Art. no. 71 400



Outer diameter Ø (mm)	A in mm	B in mm	C in mm	D in mm	E in mm	Connection for pipe size Ø mm	Art. no.
With connection couplings*, for connection to all pipe materials							
Ø 260	485	455	730	260	60	250 - 275	71 250
Ø 320	490	470	825	320	35	310 - 335	71 300
Ø 410	600	610	900	410	30	385 - 410	71 400
Ø 515	730	700	1230	515	40	495 - 525	71 500

* With connection couplings it is possible to connect pipes of different diameters. Connection couplings are necessary where the difference in outer diameter is > 12 mm. Rights reserved for technical changes

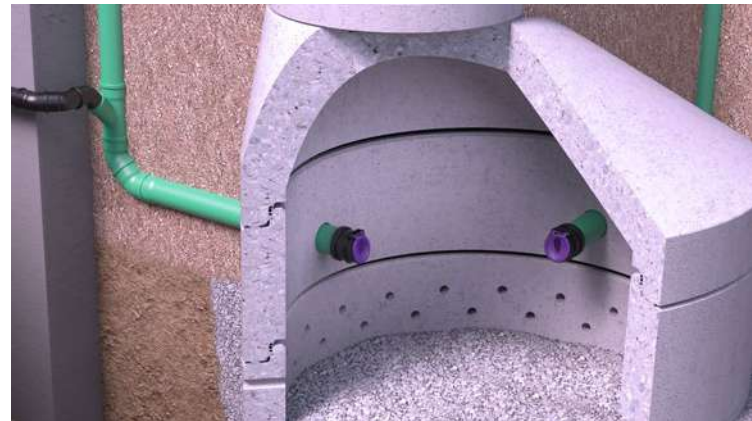
Backwater valve Pipe flap valve

The dependable solution for open end drainage pipes.

The self-actuating pipe flap valves prevent undesirable backwash into wastewater pipes in the event of backwater or high water levels. They are made entirely of polymer and so are 100 % corrosion-free. The pipe flap valves are available in various sizes from Ø 110 mm to Ø 1.000 mm.

Area of application

Pipe flap valves are used in wastewater without sewage, for example in seawater and freshwater environments. Here they serve as a backwater valve in horizontal pipes leading into chambers or outdoors.



Pipe flap valve

for connection to open end drainage pipes



Flap self-closing. Inlet/outlet for connection to PVC pipe according to EN 1451-1. KESSEL-Pipe Flap, manufactured from polymer, with free hanging self activating backwater flap. For connection to open end of pipe, gasketed inlet for push-fit connection to PVC drainage piping according to DIN 19534 and PE-HD piping according to DIN 19537.



Illustration shows Ø 160

Illustration shows Ø 250

Illustration shows Ø 800

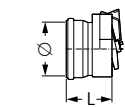


Illustration shows Ø 110 - Ø 200

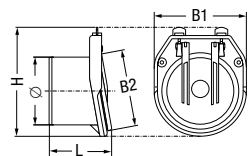


Illustration shows Ø 250 - Ø 638

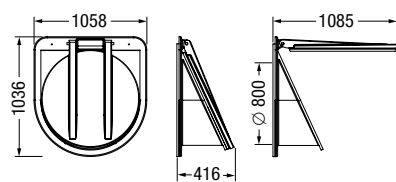


Illustration shows Ø 800

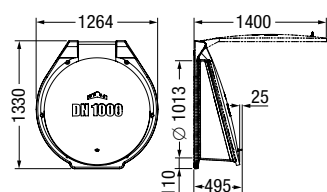


Illustration shows Ø 1000

Outer diameter Ø (mm)	DN in mm	H in mm	L in mm	B1 in mm	B2 in mm	Connection for pipe size Ø mm	Art. no.
Ø 110	-	-	120	-	-	-	79 100
Ø 125	-	-	136	-	-	-	79 125
Ø 160	-	-	142	-	-	-	79 150
Ø 200	-	-	170	-	-	-	79 200

Without connection coupling, connection according to EN 1451-1

Outer diameter Ø (mm)	DN in mm	H in mm	L in mm	B1 in mm	B2 in mm	Connection for pipe size Ø mm	Art. no.
Ø 250	250	400	220	345	280	-	79 250
Ø 315	315	450	225	400	410	-	79 300

With connection coupling*, for connection to all pipe materials

Outer diameter Ø (mm)	DN in mm	H in mm	L in mm	B1 in mm	B2 in mm	Connection for pipe size Ø mm	Art. no.
Ø 405	400	420	295	417	-	385 - 410	79 400
Ø 506	500	500	320	522	-	495 - 525	79 500
Ø 638	600	659	345	655	-	605 - 638	79 600
Ø 800**	-	-	-	-	-	-	79 800
Ø 1000**	-	-	-	-	-	-	79 1000

* With connection couplings it is possible to connect pipes of different diameters. Connection couplings are necessary where the difference in outer diameter is > 12 mm. Rights reserved for technical changes

** For wall installation

Backwater pumping station *Pumpfix S*

The Special solution with backwater valve and pump.

Stronger than the backwater: The *Pumpfix S* is the only basement drain with backwater valve, which pumps against backwater. It normally drains sewage free wastewater to the sewer by gravity – even handles incoming flood water or flooding from a burst water supply pipe. Yet it shows its true strength in case of backwater: The pump then switches on automatically and pumps the building's wastewater into the flooded sewer. It is also ideally suitable for draining outdoor basement stairs.

The *Pumpfix S* is available in two models: a compact version with polymer grating, which is particularly suitable for renovation projects, and a larger version with multiple inlet connections and a tileable cover.



Installation in waterproof concrete

The KESSEL sealing kit for installation in waterproof concrete ensures reliable protection against moisture damage. The extension section with central flange and elastomeric waterproofing membrane can also be used for deeper installation.

Additional inlet connections

In addition to the cover with integrated inlet several lateral inlets can also be attached, for a shower, washing machine and wash-basin. The *Pumpfix S* basement drain can therefore also be used as central backwater protection.

You can find the product details for
Pumpfix S here:

➤ Backwater pumping station *Pumpfix S*: page 283

Backwater valve *Universale Plus*

More advantages, less hassle with an extra measure of innovation: this plan works out! On the following pages you will find out how the *Universale Plus* basement drain with integrated backwater valve and odour trap makes it even easier for you to drain basement rooms in future.

But that's not all. Also discover why you not only save time but also save money with the *Universale Plus* – from the design to the installation through to maintenance.



The installation is also possible without waterproofing where high groundwater is not an issue



With *Ecoguss* upper section for up to 12.5 tonne loads



Installation with waterproofing against groundwater

You can find the product details for *Universale Plus* here:

➤ Backwater pumping station *Universale Plus*:
page 286

Backwater valve

The Universal

The versatile drain with backwater valve.

It couldn't be more flexible. *The Universal* is a versatile basement drain for sewage free wastewater. It is equipped with a backwater valve and a manually lockable emergency closure. *The Universal* has three inlets as a standard feature (two in Ø 50 and one in Ø 75 mm), the telescopic upper section is also rotatable, tiltable and height-adjustable. This ensures it provides maximum flexibility for the design and installation. *The Universal* is optionally available with a slotted grating made of polymer or stainless steel.



1 Drain 2 Inlet 3 Steel cover

You can find the product details for
The Universal here:

➤ Backwater valve *The Universal*: page 288

Backwater valve *Drehfix*

The compact drain for renovation.

The *Drehfix* is a basement drain with integrated, removable backwater valve (Type 5). In addition, it protects connected discharge points such as washbasins, showers or washing machines against wastewater from the sewer. With odour trap, sludge bucket, manually locked emergency closure and a discharge rate of 1.8 l/s, it can be used flexibly and is so compact that it fits in the recesses of old cast iron drains. It is therefore ideally suitable for renovation projects.



1 Drain 2 Inlet

You can find the product details for
Drehfix here:

➤ [Backwater valve *Drehfix*: page 289](#)

Accessories

Pumpfix F, Staufix FKA, Staufix SWA and Controlfix

Extension sections

			Art. no.
with centre flange	<p>Compatibility: For installation in a concrete floor <i>Pumpfix F, Staufix FKA, Staufix SWA and Controlfix</i></p> <p>Additional function: For installation in water-proof concrete</p> <p>Inclusive: Temporary construction debris cover, fully assembled, gasket set (counter flange made of polymer, screwed, elastomer sealing sheet made of NK/SBR Ø 800 mm)</p> <p>Extension: Max. 360 mm</p>		83 075
with flange and counter flange	<p>Compatibility: For installation in a concrete floor <i>Pumpfix F, Staufix FKA, Staufix SWA and Controlfix</i></p> <p>Additional function: For connection to an on-site sealing sheet</p> <p>Inclusive: Screws</p> <p>Extension: Max. 140 mm (In case of deeper installation ensure maintenance capability!)</p>		83 073
with gasket	<p>Compatibility: For installation in a concrete floor <i>Pumpfix F, Staufix FKA, Staufix SWA and Controlfix</i></p> <p>Extension: Max. 180 mm (In case of deeper installation ensure maintenance capability!)</p>		83 070

Cable extensions

for extension from 15 m or 25 m (cable length delivered: 5 m)

	for backwater pumping station <i>Pumpfix F</i>	for motorized backwater valve <i>Staufix FKA and Staufix FKA Standard</i> (up to 2015)		Art. no.
Cable extension for motor (10 m)	<p>Extension to 15 m: 1×80 890</p> <p>Extension to 25 m: 2×80 890</p>	<p>Extension to 15 m: 1×80 890</p> <p>Extension to 25 m: 2×80 890</p>		80 890
Cable extension for probe (10 m)	<p>Extension to 15 m: 2×80 889</p> <p>Extension to 25 m: 4×80 889</p>	<p>Extension to 15 m: 1×80 889</p> <p>Extension to 25 m: 2×80 889</p>		80 889
Cable extension for pump (10 m)	<p>Extension to 15 m: 1×80 891</p> <p>Extension to 25 m: 2×80 891</p>			80 891

Cover plates

		Cover	Art. no.
surface water tight	<p>Compatibility: For installation in a concrete floor <i>Pumpfix F, Staufix FKA, Staufix SWA and Controlfix</i></p> <p>Inclusive: Gasket</p> <p>Version recessed for on-site tiling, grey: For tile thicknesses of 18 mm</p> <p>(Ventilation always required when in use!)</p>		
		<p>tileable</p> <p>black</p>	<p>830 052</p> <p>830 050</p>

Spigot and Socket

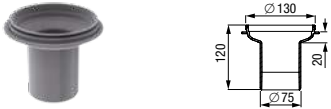


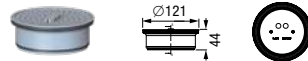

		Outer diameter Ø (mm)	Art. no.
Spigot	<p>Compatibility: For backwater valves <i>Pumpfix F, Staufix FKA, Staufix SWA and Controlfix</i></p> <p>Function: Removable inlets / outlets</p>		<p>Ø 110 83 081</p> <p>Ø 125 83 082</p> <p>Ø 160 83 083</p> <p>Ø 200* 83 084</p>
Socket	<p>Compatibility: For backwater valves <i>Pumpfix F, Staufix FKA, Staufix SWA and Controlfix</i></p> <p>Function: Removable inlets / outlets</p>		<p>Ø 110 83 085</p> <p>Ø 125 83 086</p> <p>Ø 160 83 087</p> <p>Ø 200* 83 088</p>

* In-/Outlet Ø 200, hydraulics corresponds to Ø 160

Accessories

Pumpfix F, Staufix FKA, Staufix SWA and Controlfix

Hygiene and odour stop

				Cover	Art. no.
Drain body	Compatibility: For lowest installation; for backwater pumping station <i>Pumpfix F</i>			black grey	680 796 680 798
Drain body	Compatibility: Seal water height 50 mm; for backwater pumping station <i>Pumpfix F</i>			black grey	680 795 680 797
additionally Multistop	Compatibility: For backwater pumping station <i>Pumpfix F</i> Function: Odour, foam, rodent and insect stop				48 500
additionally Megastop	Compatibility: For backwater pumping station <i>Pumpfix F</i> Function: Mechanical odour trap inclusive hair filter for KESSEL upper sections				48 550
additionally odour trap	Compatibility: For backwater pumping station <i>Pumpfix F</i> Seal water height: 50 mm (Ventilation always required when in use!)				680 696

Hygiene

				Art. no.
Hair filter	Compatibility: Art. no. 48 500; for backwater pumping station <i>Pumpfix F</i>			48 700

Rodent / Insect protection

for *Staufix FKA* and *Staufix SWA*

				Art. no.
Rat protection flap	Compatibility: <i>Staufix FKA</i> from 01/2011 to 2015 (with flap in pendulum position) Inclusive: Stainless steel shield			80 037




Maintenance

				Art. no.
Testing funnel	Compatibility: For all <i>Staufix FKA</i> and <i>Staufix SWA</i> backwater valves (Ø 110, Ø 125, Ø 160) Inclusive: Gasket			70 214



Accessories

Pumpfix F, Staufix, Staufix FKA, Staufix SWA and Controlfix

Control unit accessories

			Art. no.
Audible alarm	Compatibility: For all control units with SDS function Cable length: 20 m		20 162
Potential-free contact	Compatibility: For all control units up to 12/2016 with SDS function		80 072
Activation code for potential-free contact	Compatibility: For Comfort control units beginning model year 2017		80 077

Conversion kits

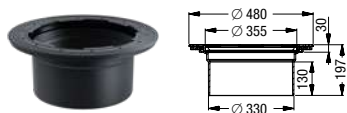
			Outer diameter Ø (mm)	Art. no.
Rodent protection flap	Compatibility: Art. no. 70 100, 70 125, 70 150, 71 100, 71 125, 71 150, 72 100, 72 125, 72 150, 73 100, 73 125, 73 150, 720 ..., 730 ... Material: Made of stainless steel		Ø 90 - Ø 110	70 233
			Ø 125 - Ø 200	70 234
Backwater flap	Compatibility: For upgrade from type 1 to type 2		Ø 90 - Ø 110	70 231
			Ø 125 - Ø 200	70 232

Accessories

Staufix

Extension sections

made of polymer



with flange

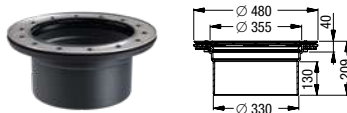
for deeper installation

Inclusive: Sealing

Extension: Max. 147 mm

Note: In case of deeper installation ensure maintenance capability!

Art. no. 830 070



with flange and counter flange

for deeper installation

Material: Counter flange

made of stainless steel

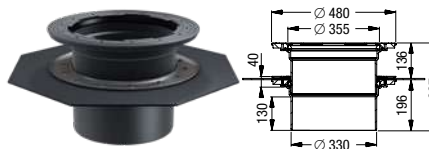
Inclusive: Sealing

Extension: Max. 147 mm

Compatibility: For connection to an on-site membrane

Note: In case of deeper installation ensure maintenance capability!

Art. no. 830 073



with flange

for installation in waterproof concrete

Inclusive sealing set:

Elastomer waterproofing membrane

made of NK/SBR Ø 700 mm

Extension: Max. 294 mm

Delivery: Completely assembled.

Note: Suitable for installation in the concrete slab/floor.

Art. no. 830 075

Spigot / Socket

made of polymer



Spigot

removable fitting mountable on both sides and in different dimensions

Outer diameter Ø (mm)	Art. no.
Ø 90	83 090
Ø 100	830 200
Ø 110	830 100
Ø 125	83 082
Ø 160	83 083
Ø 200	83 084



Socket

removable fitting mountable on both sides and in different dimensions

Outer diameter Ø (mm)	Art. no.
Ø 90	83 091
Ø 100	830 202
Ø 110	830 101
Ø 125	83 086
Ø 160	83 087
Ø 200	83 084

1.2 Backwater chambers

For installation in the concrete slab
or underground

Standard backwater chamber or modular backwater chamber Ø 1000 with *Controlfix* clean out

The robust solution in front of the building

A backwater chamber in front of the building offers significant advantages. It enables all drainage points that are at risk of backwater to be safeguarded outside the building at a single central and maintenance-friendly point. Noise nuisance, for example due to pumps or similar, can be ruled out and there is no lost space inside the building.

Double use

The backwater chamber can simultaneously be used as a transition chamber – with two side inlets for the drainage of the building, roof and yard.

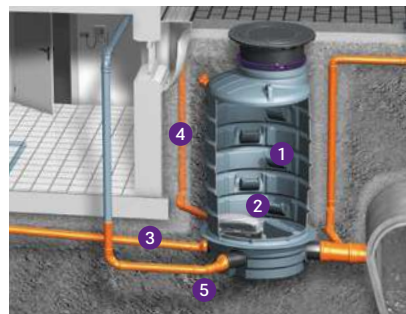


Thanks to the clean out *Controlfix*, the backwater chambers can be equipped with various conversion kits:

- Conversion kit *Staufix SWA*: page 56
- Conversion kit *Staufix FKA*: page 56
- Conversion kit *Pumpfix F*: page 56

Standard backwater chamber Ø 1000 with *Controlfix*

Thanks to its monolithic construction using unbreakable, impact-resistant material, the standard backwater chamber Ø 1000 is permanently leak-proof and secure against the ingress of roots. In addition, it can also be ideally adapted to the ground level thanks to its vertically, adjustable upper section.



- 1 Backwater chamber
- 2 Clean out
- 3 Basement drains
- 4 Roof drains
- 5 Basement drainage

Modular backwater chamber Ø 1000 with *Controlfix*

Thanks to its modular construction with a technical module as well as a large selection of chamber modules and upper sections, the modular backwater chamber can be adapted to suit any individual installation situation. Ground water resistance up to a depth of 3.000 mm



- 1 System base
- 2 Clean out
- 3 System chamber
- 4 Height adjustable upper section

Backwater inspection chamber Ø 1000 with *Controlfix*

For underground installation



Z-42.1-333

Polyethylene PE-HD.

Monolithic design, with open continuous channel and clean out *Controlfix*, with integrated access steps, watertight, resistant to aggressive wastewater, with telescopic height-adjustable protective cover made of polymer for use during the construction period (can be used as a cover in green areas).

Triple 160 mm hub type gasketed inlets (left and right inlets with open channel passage through chamber, center hub inlet connected to housing for insertion of KESSEL backwater valve). Available backwater valve options - KESSEL *Staufix SWA*, KESSEL *Staufix FKA* or KESSEL *Pumpfix F*.

For connection to PVC pipe according to EN 1401-1 and PE-HD connections according to EN 12666-1.

Installation:

Handles groundwater depths up to 2.000 mm

Distance from base of chamber to:

Base of inlet approx. 136 mm

Base of outlet approx. 108 mm

Note: Further chamber heights (on request)

➤ **Conversion kits:** see page below

➤ **Accessories:**

- page 64 – 65
- Depending on installation depth, entrance access steps may be required (see page 65)



Installation depth in mm

Art. no.

3 inlets Ø 160 / 1 outlet Ø 200

H1: 1180	88 10 05
H2: 1680	88 15 05
H3: 2180	88 20 05
H4: 2680	88 25 05
H5: 3180	88 30 05

3 inlets Ø 160 / 1 outlet Ø 160

H1: 1180	88 10 05-DN 150
H2: 1680	88 15 05-DN 150
H3: 2180	88 20 05-DN 150
H4: 2680	88 25 05-DN 150
H5: 3180	88 30 05-DN 150

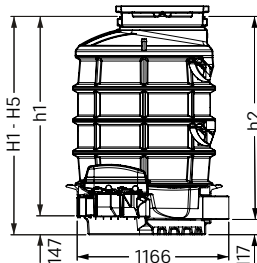
Standard cover on-site



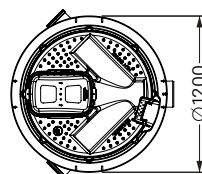
Accessories Art. no. 86 01 22 / 86 01 16



Inspection chamber including temporary construction debris cover



Height	h1	h2
H1	1046	1072
H2	1528	1558
H3	2028	2058
H4	2533	2563
H5	3033	3063



Conversion kits

for models made on or after Jan 2011

Art. no.

Backwater pumping *Pumpfix F*

Compatibility: Engineering systems base backwater chamber Ø 1000, for Ø 110 – Ø 200*
Inclusive: Komfort control unit
Cable length: 15 m
 ➤ Cable extension: page 54



80 102



Motorized backwater valve *Staufix FKA*

Compatibility: Engineering systems base backwater chamber Ø 1000, for Ø 110 – Ø 200*
Inclusive: Komfort control unit
Cable length: 15 m
 ➤ Cable extension: page 54



80 104



Backwater valve *Staufix SWA*

Compatibility: Engineering systems base backwater chamber Ø 1000, for Ø 110 – Ø 200*



80 091



* In-/Outlet Ø 200, hydraulics corresponds to Ø 160

Engineering systems base backwater chamber with *Controlfix*

For installation in a concrete slab or outdoor underground installation



Polyethylene PE-HD

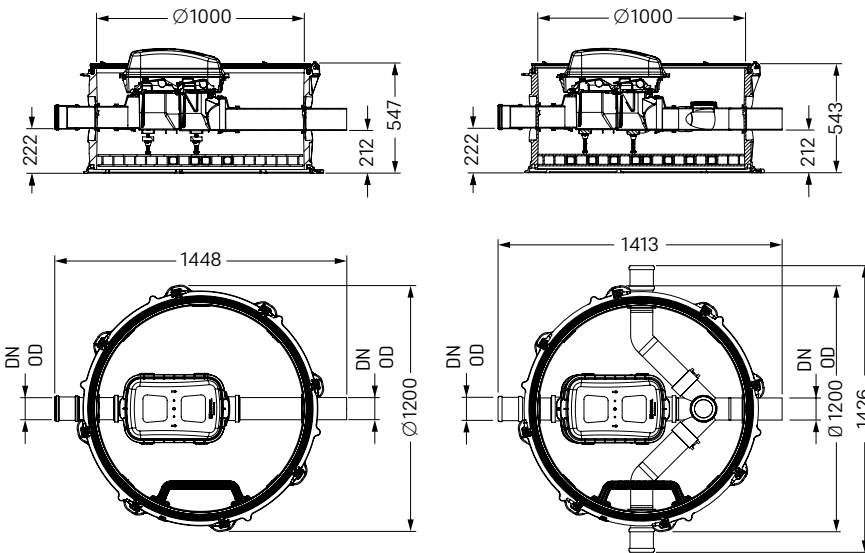
Version:

- integrated clean out *Controlfix*
- closed channel passage or two inlets in direction of flow

Installation:

Handles groundwater depths up to 3.000 mm

- **Installation:** in combination with system chamber page 62 – 63
- **Conversion kits:** see page below
- **Accessories:** pages 64 – 65



With closed channel passage

Outer diameter Ø (mm)	Art. no.
Ø 110	85 10 01
Ø 125	85 12 51
Ø 160	85 15 01

With two inlets 90° in flow direction

Outer diameter Ø (mm)	Art. no.
Ø 110	85 10 03
Ø 125	85 12 53
Ø 160	85 15 02

Engineering systems base backwater chamber in combination with system chamber Ø 1000

Conversion options

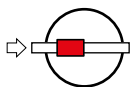
- Conversion kit *Staufix SWA*
- Conversion kit *Staufix FKA*
- Conversion kit *Pumpfix F*



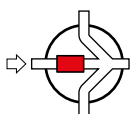
Channel passage:

with closed channel passage Ø...

Version Ø 200: (on request)



with two inlets in direction of flow Ø...
left + right 90°



Conversion kits

for models made on or after Jan 2011

		Art. no.
Backwater pumping <i>Pumpfix F</i>	<p>Compatibility: Engineering systems base backwater chamber Ø 1000, for Ø 110 – Ø 200*</p> <p>Inclusive: Komfort control unit</p> <p>Cable length: 15 m</p> <p>➤ Cable extension: page 54</p>	80 102
Motorized backwater valve <i>Staufix FKA</i>	<p>Compatibility: Engineering systems base backwater chamber Ø 1000, for Ø 110 – Ø 200*</p> <p>Inclusive: Komfort control unit</p> <p>Cable length: 15 m</p> <p>➤ Cable extension: page 54</p>	80 104
Backwater valve <i>Staufix SWA</i>	<p>Compatibility: Engineering systems base backwater chamber Ø 1000, for Ø 110 – Ø 200*</p>	80 091

* In-/Outlet Ø 200, hydraulics corresponds to Ø 160

Engineering system chamber Ø 1000 with access opening Ø 600

for combination with engineering system base

EN 13598 Part 2 Z-42.1-527

Made of polyethylene PE-HD

Installation: For underground installation; handles groundwater depths up to 3000 mm

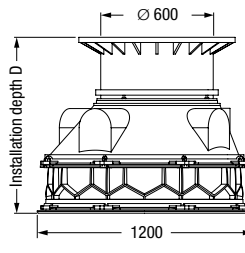
Modular design comprising:

- Chamber rings with access steps fitted
- With telescopic height adjustable upper section
- Round cover made of cast iron
- Includes all sealing gaskets and wedge connectors required for installation

Delivery: As individual elements

Remark: Covers surface water tight

Note: Additional installation depths (on request)



Installation depth D in mm Art. no.

Class A/B

1130 - 1379	874 00 18
1380 - 1629	874 00 24
1630 - 1879	874 00 30
1880 - 2129	874 00 36
2130 - 2379	874 00 42
2380 - 2629	874 00 48
2630 - 2879	874 00 54
2880 - 3129	874 00 60

Class D

1130 - 1379	874 00 19
1380 - 1629	874 00 25
1630 - 1879	874 00 31
1880 - 2129	874 00 37
2130 - 2379	874 00 43
2380 - 2629	874 00 49
2630 - 2879	874 00 55
2880 - 3129	874 00 61

Engineering system chamber Ø 1000 with access opening Ø 800

for combination with engineering system base

EN 13598 Part 2 Z-42.1-527

Made of polyethylene PE-HD

Installation: For installation in the concrete slab; handles groundwater depths up to 3000 mm

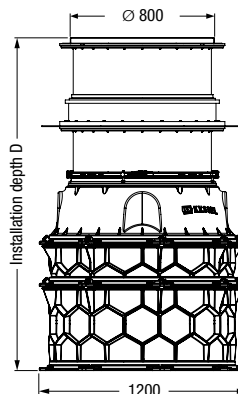
Modular design comprising:

- For waterproof concrete with flange and counter flange
- Chamber rings with access steps fitted
- With telescopic height adjustable upper section
- Square cover made of stainless steel, class A/L 15 or round cover in class K 3
- Includes all sealing gaskets and wedge connectors required for installation

Delivery: As individual elements

Remark: Covers surface water tight

Note: Additional installation depths, upper sections and covers class B/D (on request)



Cover tileable, square

Installation depth D in mm Art. no.

668 - 917	874 00 03
918 - 1167	874 00 09
1168 - 1417	874 00 15
1418 - 1667	874 00 21
1668 - 1917	874 00 27

Cover not tileable, square, anti-slip

Installation depth D in mm Art. no.

653 - 902	874 00 05
903 - 1152	874 00 11
1153 - 1402	874 00 17
1403 - 1652	874 00 23
1653 - 1902	874 00 29

Cover not tileable, round

Installation depth D in mm Art. no.

638 - 887	874 02 22
888 - 1137	874 02 23
1138 - 1387	874 02 24
1388 - 1637	874 02 25
1638 - 1887	874 02 26

Engineering system chamber Ø 1000 with access opening Ø 800

for combination with engineering system base

EN 13598 Part 2 Z-42.1-527

Made of polyethylene PE-HD

Installation: For underground installation; handles groundwater depths up to 3000 mm

Modular design comprising:

- Chamber rings with access steps fitted
- With telescopic height adjustable upper section
- Covers made of stainless steel
- Includes all sealing gaskets and wedge connectors required for installation

Delivery: As individual elements

Remark: Covers surface water tight

Note: Additional installation depths, upper sections and covers class B/D (on request)



Illustration shows Art. no. 874 01 43



Illustration shows Art. no. 874 00 20

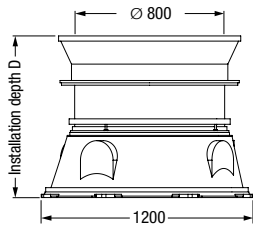


Illustration shows Art. no. 874 01 58

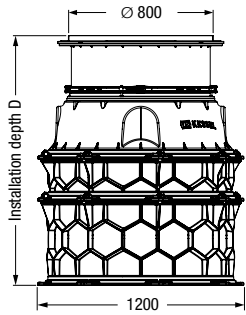


Illustration shows Art. no. 874 00 02

Round cover

Installation depth D in mm Art. no.

Class K 3

375 - 624	874 01 22
625 - 874	874 01 23
875 - 1124	874 01 24
1125 - 1374	874 01 25
1375 - 1624	874 01 26
1625 - 1874	874 01 27
1875 - 2124	874 01 28
2125 - 2374	874 01 29
2375 - 2624	874 01 30
2625 - 2874	874 01 31
2875 - 3124	874 01 32

Square cover

Installation depth D in mm Art. no.

Class B

620 - 869	874 01 41
870 - 1119	874 01 42
1120 - 1369	874 01 43

Class D

620 - 869	874 01 58
870 - 1119	874 01 59
1120 - 1369	874 01 60

Square cover

Installation depth D in mm Art. no.

Class A/L 15, not tileable, anti-slip

396 - 645	874 00 04
646 - 895	874 00 10
896 - 1145	874 00 16
1146 - 1395	874 00 22
1396 - 1645	874 00 28
1646 - 1895	874 00 34
1896 - 2145	874 00 40
2146 - 2395	874 00 46
2396 - 2645	874 00 52
2646 - 2895	874 00 58
2896 - 3145	874 00 64




Class A/L 15, tileable

411 - 660	874 00 02
661 - 910	874 00 08
911 - 1160	874 00 14
1161 - 1410	874 00 20
1411 - 1660	874 00 26
1661 - 1910	874 00 32
1911 - 2160	874 00 38
2161 - 2410	874 00 44
2411 - 2660	874 00 50
2661 - 2910	874 00 56
2911 - 3160	874 00 62

Accessories

Backwater chambers

Cover plates

			Cover	Art. no.
with ventilation	Compatibility: Backwater inspection chamber Ø 1000 Material: Class A, B in cast iron and concrete Class D in cast iron Inclusive: Lockable cover plates with <i>Lock & Lift</i> -function		Class A	860 134
			Class B	860 135
			Class D, <i>Lock & Lift</i>	860 164
surface water tight	Compatibility: Backwater inspection chamber Ø 1000 Material: In cast iron Inclusive: Lockable cover plates with <i>Lock & Lift</i> -function		Class A/B, <i>Lock & Lift</i>	860 161
			Class D, <i>Lock & Lift</i>	860 160
	Compatibility: Backwater inspection chamber Ø 1000 Material: In cast iron and concrete		Class A	860 130
			Class B	860 131

Upper sections

			Telescopic height adjustable	Art. no.
without recesses for a sludge bucket	Compatibility: Covers class A/B/D Inclusive: Clamping ring, with <i>Lock & Lift</i> function		65 - 579	860 152
			65 - 329	860 153
can be assembled with standard concrete rings	Compatibility: For standard bearing ring / concrete/cast covers, class A/B/D; for backwater inspection chamber Ø 1000		79 - 579	860 154
			79 - 329	860 155
			79 - 579	860 156

Extension section

			Art. no.
500 mm	Compatibility: Engineering systems base backwater chamber Inclusive: 2 access steps, installed Note: Without gasket and connecting wedges		680 371
250 mm	Compatibility: Engineering systems base backwater chamber Inclusive: 1 access step, installed Note: Without gasket and connecting wedges		680 370







Accessories

Backwater chambers

Gasket / Embedded step / Locking and removal key / Connection and attachment sets

			Outer diameter Ø (mm)	Art. no.
Lip gasket	Compatibility: Art. no. 860 152, 860 153, 860 154, 860 155		Ø 600	860 116
Embedded step	Compatibility: Art. no. 860 152, 860 153, 860 154, 860 155 Inclusive: Drilling template, step, hand rail, screws Note: The embedded step can be fitted to the upper section (Art. no. 860 152, 860 153, 860 154, 860 155) in the factory at an additional charge			860 109


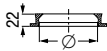
Locking and removal key / Connection and attachment sets

			Voltage	Art. no.
Cable piping gasket set	Compatibility: Control unit 230 V and 400 V		in the building in the building	85 401 85 402
			in the chamber in the chamber	85 403 85 404
Locking and removal key	Compatibility: Chamber cover			915 595
Set of connecting wedges	Compatibility: Art. no. 680 371 and 680 370 Set-content: 10 pieces			680 373
Profiled gasket	Compatibility: Art. no. 680 371 and 680 370			680 125
Cable attachment set	Compatibility: Engineering systems base backwater chamber Ø 1000 Set-content: 3 pieces of clamps			28 076

Hole saw

			Outer pipe diameter in mm	Drill size in mm	Art. no.
Hole saw set	Compatibility: Engineering systems base backwater chamber Ø 1000 Inclusive: Saw blade holder				
			Ø 50	60	500 101
			Ø 75	92	
			Ø 110	121	
			Ø 110	121	500 100
			Ø 125	133	
			Ø 160	168	

Sealing

			Nominal pipe diameter in mm	Outer pipe diameter in mm	Art. no.
Pipe sealing gasket	Compatibility: Engineering systems base backwater chamber Ø 1000 Drill size: Ø 50: 60 mm Ø 75: 92 mm Ø 110: 121 mm Ø 125: 133 mm Ø 160: 168 mm		DN 50	Ø 50	850 114
			DN 70	Ø 75	850 116
			DN 100	Ø 110	850 117
			DN 125	Ø 125	850 118
			DN 150	Ø 160	850 119

2. Hybrid lifting stations

Backwater protection with integrated
wastewater pump

Overview of Range of lifting stations with hybrid technology

2.1 Backwater pumping station



Backwater pumping station
Pumpfix F

➤ Page 74



Type of wastewater



Wastewater containing sewage



Wastewater without sewage

Function



Protects and disposes
in the event of backwater

Installation situation



Outdoor, underground
installation



Indoor, exposed installation



Floor slab installation

2.2 Hybrid lifting station



Hybrid lifting station
Ecolift L

➤ Page 82

New



Hybrid lifting station
Ecolift XL

➤ Page 84



If there is no slope to the sewer:

➤ Lifting stations: page 106

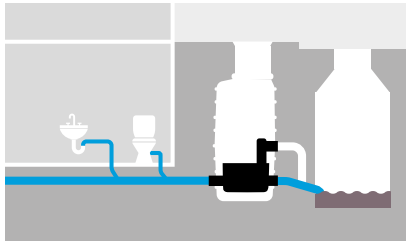
➤ Pumping stations: page 142

Ecolift functional principle

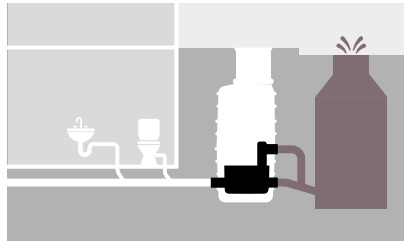
How does a hybrid lifting station work?



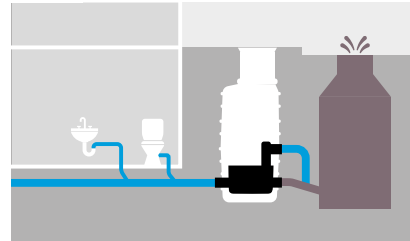
A hybrid lifting station combines the safety of a lifting station with the efficiency of drainage via a natural slope. During normal operation, wastewater flows with gravity through the *Ecolift XL* into the public sewer. When flooding occurs backwater flap(s) automatically shut to protect the building. Pump(s) then activate to discharge the building's wastewater into the public sewer when backwater flap(s) are closed.



Hybrid lifting stations make use of the natural slope to the sewer.



Motorised flap(s) close to prevent backwater from entering from the surcharged sewer.



The building's wastewater is pumped into the surcharged sewer during times of backwater.



Environmentally friendliness and cost efficiency

As hybrid lifting stations only pump in exceptional cases, they are more environmentally friendly, cheaper to operate and require less maintenance than other lifting stations. The continuous discharge via the natural gradient produces a self-cleaning effect, which prevents the dirt deposits usually found in lifting stations.



Minimum noise emissions

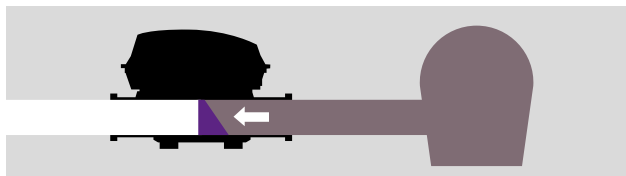
A hybrid lifting station produces no noise during normal operation – ideal for rooms that are often used by people.



Uninterrupted operation

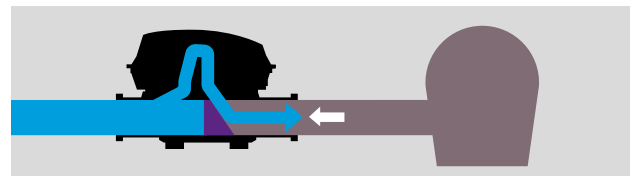
Drainage can take place safely with a hybrid lifting station, even in the case of power failure. The integrated backwater valve remains functional thanks to the backup battery.

Function backwater pumping station



Protects in the event of backwater

The backwater flap prevents wastewater from the public sewer from backing up through the drainage pipe and flooding the building.



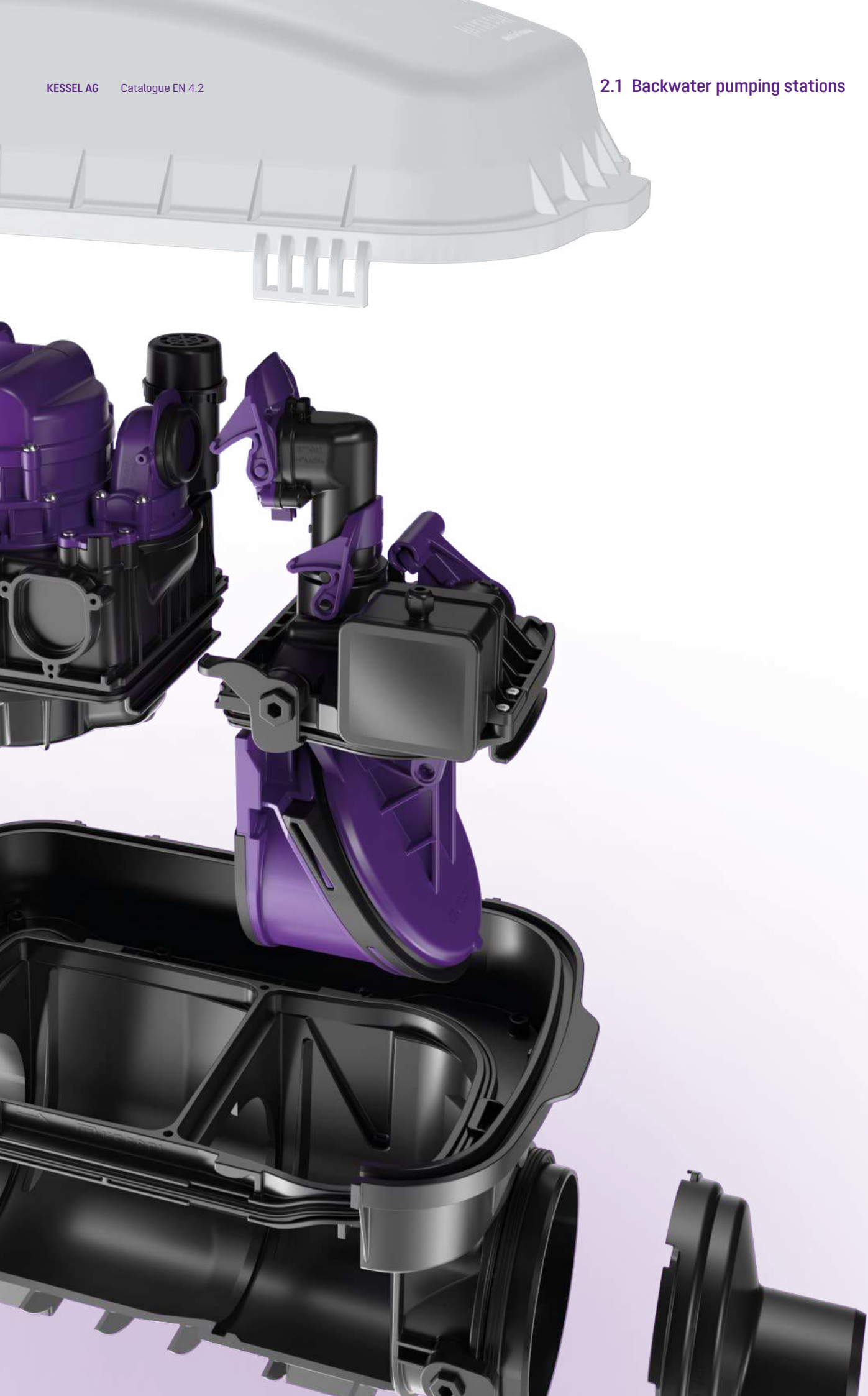
Disposes in the event of backwater

Despite backwater from the public sewer and closed backwater flap(s), domestic wastewater can be disposed of via a pump. This ensures that the building's drainage system functions even in the event of backwater.

2.1 Backwater pumping stations

The unique backwater solution





Backwater pumping station *Pumpfix F*

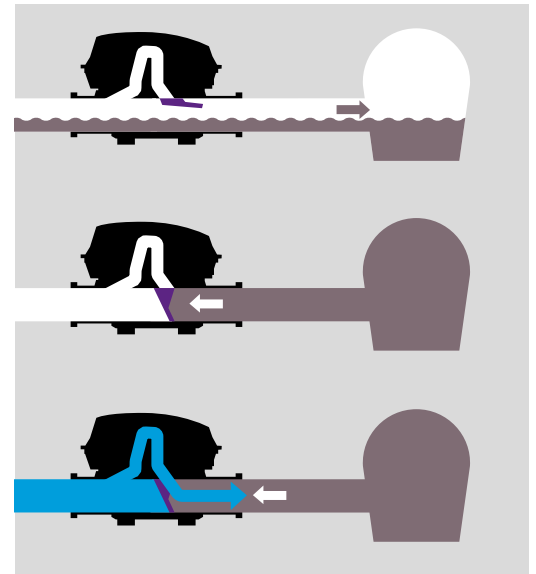
The unique backwater solution.

More than a backwater valve: *Pumpfix F* is the only backwater valve that pumps against backwater. In normal operation, the backwater pumping station continuously disposes of the wastewater via the slope to the main sewer, making it energy-neutral. In the event of backwater, the backwater flap closes automatically to protect the building from flooding and any wastewater from the building is pumped into the flooded sewer via the integrated sewage. The integrated cutting system shreds solids meaning the *Pumpfix F* can be used with wastewater containing sewage. It can also drain basement staircases up to 5 m².

Pumpfix F is available in two variants – for installation in an exposed drainage pipe and for floor slab installation, where you can choose between a black cover or tileable cover.

Application

For flats under the backwater level with no access to a toilet above backwater level.



How it works

Pumpfix F is the only backwater valve with hybrid function: In normal operation it uses the natural slope to the sewage pipe. In the event of backwater from the sewage pipe, the pump is automatically switched on in order to reliably pump the building's wastewater into the flooded sewer.



1 Backwater pumping station 2 Control unit 3 Sealing gasket set



1 Backwater pumping station 2 Control unit

Ventilation

Integrated ventilation eliminates the requirement for costly roof ventilation pipes

Motor

Automatically closes the backwater flap in the event of backwater

Body with only 9 mm integrated slope

Ideal for renovation work

Installation kit for the floor slab with integrated drainage function

The backwater valve is available for floor slab installation and can also be installed in waterproof concrete by using an extension piece with sealing flange and an elastomer waterproofing membrane. The integrated drainage function ensures that any surface water, for example due to a pipe break, will be pumped into the sewer even during times of backwater.



Flange for groundwater resistance available.

Optional with gasket set.

Comfort control unit

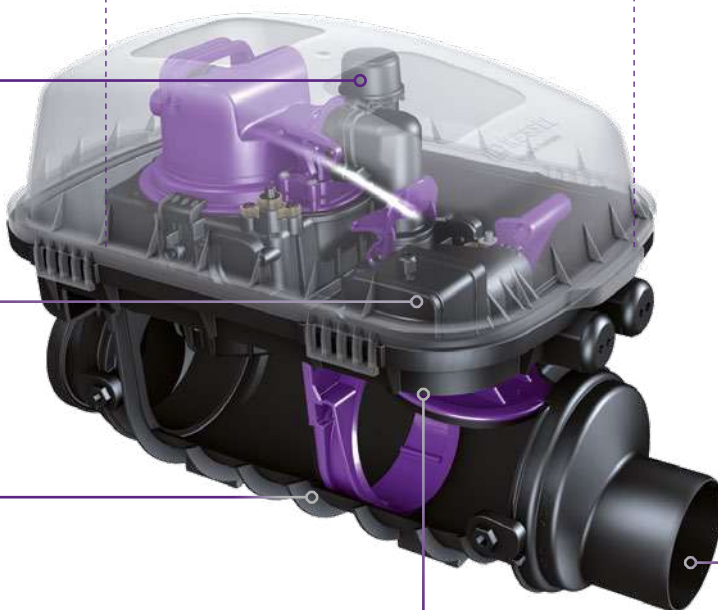
with multilingual (EN, DE, FR, IT, PL, NL) digital display for operating state and servicing instructions as well as connection option for building management system.

Note: Scandinavian package available on request.



Plug & Play control unit

with self-diagnosis system SDS for maximum safety



Motorized Flap

Closed backwater flap with integrated gasket provides secure and reliable protection during backwater

Removable inlet / outlet connections – also in Ø 200

- Flange/spigot for customized connections
- Variable inlet and outlet sizes available

Backwater pumping station *Pumpfix F*

Installation in a concrete slab / floor



Z-53.2-388

Made of polymer, with telescopic upper section for continuous height- and level adjustment. For installation depth (D) from 486 – 640 mm, Installation area 750 × 750 mm. With surface water tight polymer cover plate class A 15 and integrated floor drain.

Installation kit with choice of cover.

Backwater pumping station according to EN 13564 Type 3 with pump (1kW/230V) and backwater valve, pump activates during backwater, suitable for wastewater with or without sewage.

Plug-and-Play control unit with connection option to building management system and alarm, display for operating status and battery back-up, protection type IP 54, with integrated self diagnosis system SDS, motorized backwater flap, *Pumpfix F* body rated protection type IP 68 (3 m, 24 h).

Power cable length: 5 m (15 m available on request).

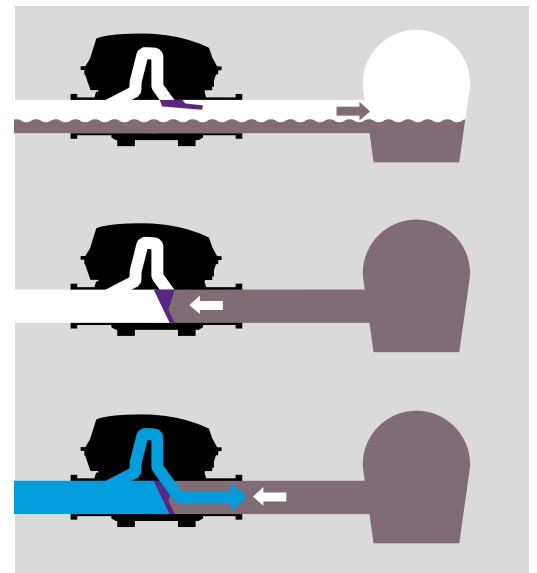
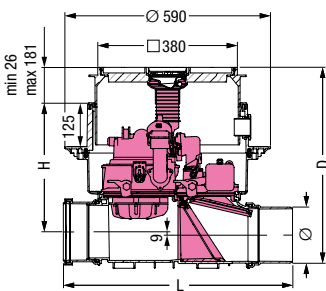
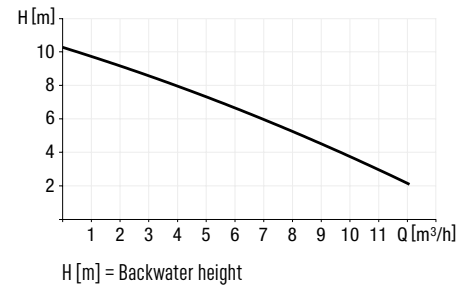
Accessories:

Extension sections for installation in waterproof concrete see page 76 – 77



Outer diameter Ø (mm)	L × H in mm	Art. no.
With recessed cover for on-site tiling with integrated drain		
Ø 110	642 × 394	24 100X
Ø 125	645 × 387	24 125X
Ø 160	656 × 370	24 150X
Ø 200*	720 × 348	24 200X
With black cover with integrated drain		
Ø 110	642 × 394	24 100S
Ø 125	645 × 387	24 125S
Ø 160	656 × 370	24 150S
Ø 200*	720 × 348	24 200S

Pumping capacity



How it works

Pumpfix F is the only backwater valve with hybrid function: In normal operation it uses the natural slope to the sewage pipe. In the event of backwater from the sewage pipe, the pump is automatically switched on in order to reliably pump the building's wastewater into the flooded sewer.

* In-/Outlet Ø 200, hydraulics corresponds to Ø 160



Backwater pumping station *Pumpfix F*

Installation in an exposed wastewater pipe



Z-53.2-388

Made of polymer, with protective cover. Backwater pumping station according to EN 13564 Type 3 with pump (1kW/230V) and backwater valve, pump activates during backwater, suitable for wastewater with or without sewage.

Plug-and-Play control unit with connection option to building management system and alarm, display for operating status and battery back-up, protection type IP 54, with integrated self diagnosis system SDS, motorized backwater flap, *Pumpfix F* body rated protection type IP 68 (3 m, 24 h).

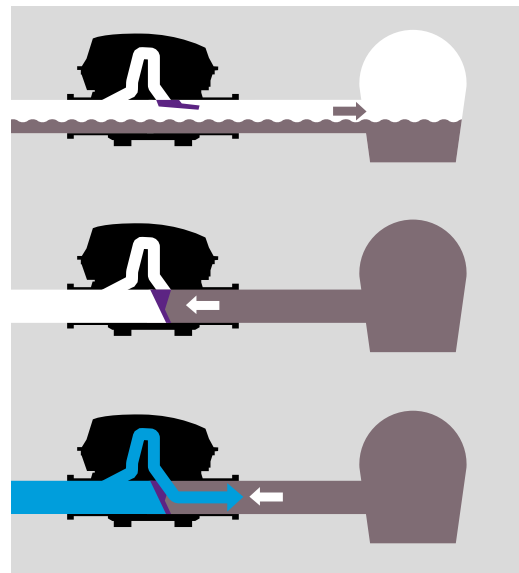
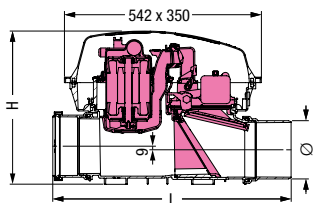
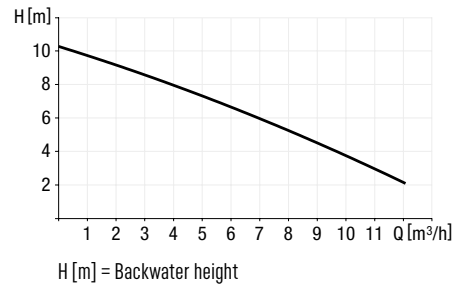
Power cable length: 5 m (15 m available on request).

➤ **Accessories:** pages 76 – 77



Outer diameter Ø (mm)	L × H in mm	Art. no.
Ø 110	642 × 422	24 100
Ø 125	645 × 422	24 125
Ø 160	656 × 422	24 150
Ø 200*	720 × 422	24 200

Pumping capacity



How it works

Pumpfix F is the only backwater valve with hybrid function: In normal operation it uses the natural slope to the sewage pipe. In the event of backwater from the sewage pipe, the pump is automatically switched on in order to reliably pump the building's wastewater into the flooded sewer.


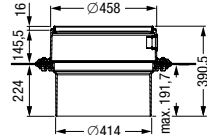

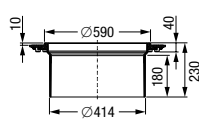

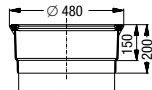
* In-/Outlet Ø 200, hydraulics corresponds to Ø 160



Accessories




Pumpfix F

Extension sections

				Art. no.
with centre flange	<p>Compatibility: For installation in a concrete floor <i>Pumpfix F</i></p> <p>Additional function: For installation in water-proof concrete</p> <p>Inclusive: Temporary construction debris cover, fully assembled, gasket set (counter flange made of polymer, screwed, elastomer sealing sheet made of NK/SBR Ø 800 mm)</p> <p>Extension: Max. 360 mm</p>			83 075
with flange and counter flange	<p>Compatibility: For installation in a concrete floor <i>Pumpfix F</i></p> <p>Additional function: For connection to an on-site sealing sheet</p> <p>Inclusive: Screws</p> <p>Extension: Max. 140 mm (In case of deeper installation ensure maintenance capability!)</p>			83 073
with gasket	<p>Compatibility: For installation in a concrete floor <i>Pumpfix F</i></p> <p>Extension: Max. 180 mm (In case of deeper installation ensure maintenance capability!)</p>			83 070

Cable extensions

for extension from 15 m or 25 m (*Pumpfix F* supplied with 5 meter cables)

			Art. no.
Cable extension for motor (10 m)	<p>Extension to 15 m: 1×80 890</p> <p>Extension to 25 m: 2×80 890</p>		80 890
Cable extension for probe (10 m)	<p>Extension to 15 m: 2×80 889</p> <p>Extension to 25 m: 4×80 889</p>		80 889
Cable extension for pump (10 m)	<p>Extension to 15 m: 1×80 891</p> <p>Extension to 25 m: 2×80 891</p>		80 891

Cover plates

			Cover	Art. no.
surface water tight	<p>Compatibility: For installation in a concrete floor <i>Pumpfix F</i></p> <p>Inclusive: Gasket</p> <p>Version recessed for on-site tiling, grey: For tile thicknesses of 18 mm (Ventilation always required when in use!)</p>		tileable	830 052
			black	830 050

Spigot and Socket

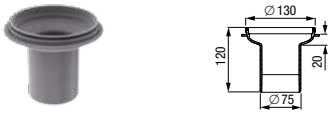
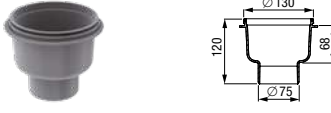
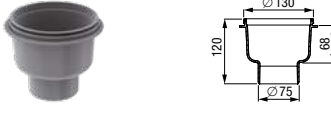
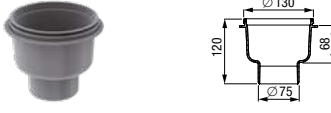


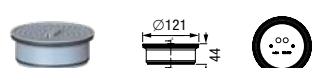
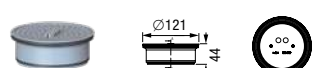


			Outer diameter Ø (mm)	Art. no.
Spigot	<p>Compatibility: For backwater valves <i>Pumpfix F</i></p> <p>Function: Removable inlets / outlets</p>		Ø 110	83 081
			Ø 125	83 082
			Ø 160	83 083
			Ø 200*	83 084
Socket	<p>Compatibility: For backwater valves <i>Pumpfix F</i></p> <p>Function: Removable inlets / outlets</p>		Ø 110	83 085
			Ø 125	83 086
			Ø 160	83 087
			Ø 200*	83 088

* In-/Outlet Ø 200, hydraulics corresponds to Ø 160

Accessories

Pumpfix F




Hygiene and odour stop

				Cover	Art. no.
Drain body	Compatibility: For lowest installation; for backwater pumping station <i>Pumpfix F</i>			black grey	680 796 680 798
Drain body	Compatibility: Seal water height 50 mm; for backwater pumping station <i>Pumpfix F</i>			black grey	680 795 680 797
additionally <i>Multistop</i>	Compatibility: For backwater pumping station <i>Pumpfix F</i> Function: Odour, foam, rodent and insect stop				48 500
additionally <i>Megastop</i>	Compatibility: For backwater pumping station <i>Pumpfix F</i> Function: Mechanical odour trap inclusive hair filter for KESSEL upper sections				48 550
additionally odour trap	Compatibility: For backwater pumping station <i>Pumpfix F</i> Seal water height: 50 mm (Ventilation always required when in use!)				680 696

Hygiene

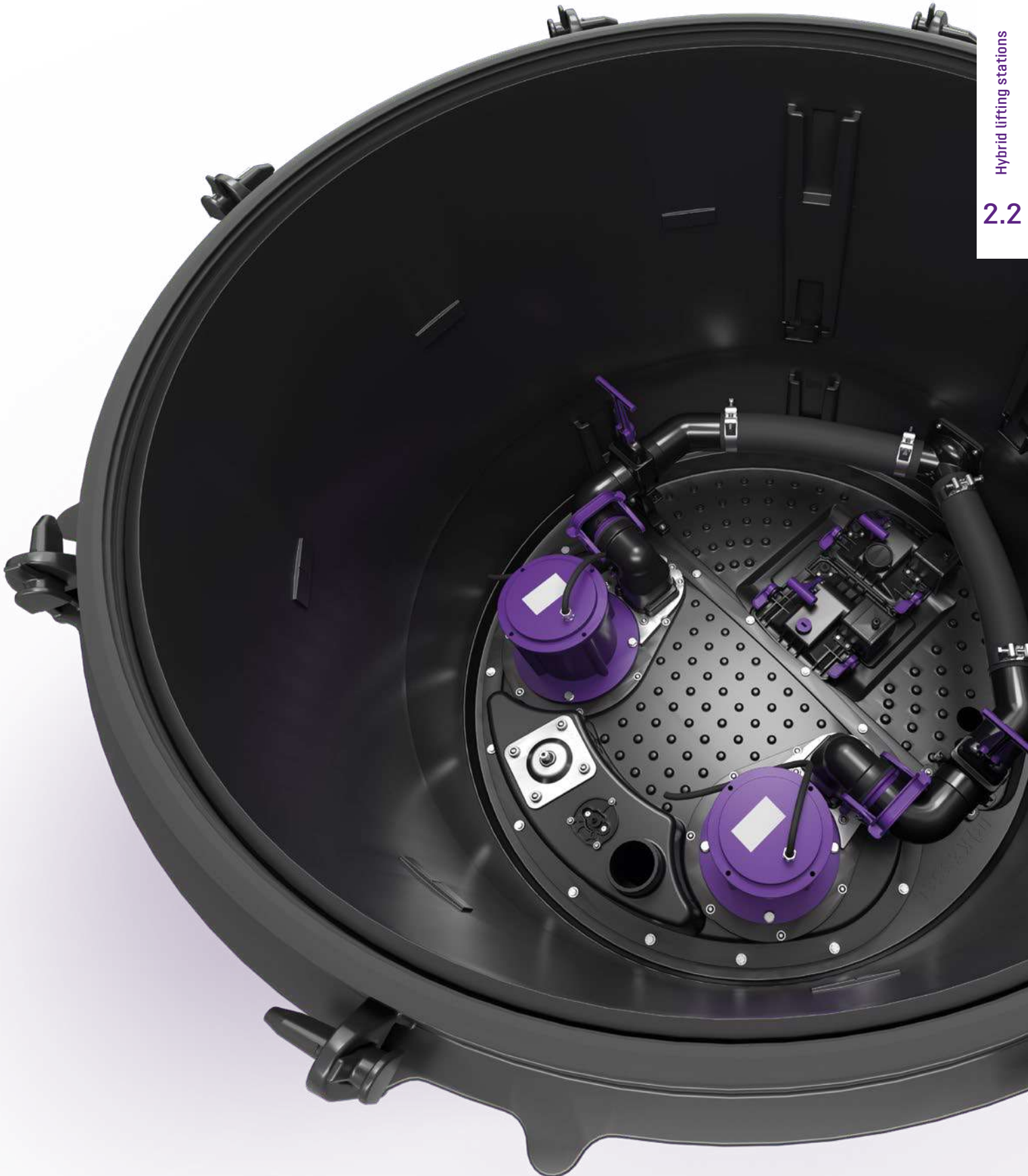
				Art. no.
Hair filter	Compatibility: Art. no. 48 500; for backwater pumping station <i>Pumpfix F</i>			48 700

Control unit accessories

			Art. no.
Audible alarm	Compatibility: For all control units with SDS function Cable length: 20 m		20 162
Potential-free contact	Compatibility: For all control units up to 12/2016 with SDS function		80 072
Activation code for potential-free contact	Compatibility: For Comfort control units beginning model year 2017		80 077

2.2 Hybrid lifting stations

The economical alternative
to lifting stations



Hybrid lifting station *Ecolift XL*

The powerful solution for commercial applications and multi-family homes.

Concentrated power: The *Ecolift XL* is a larger and more powerful version of the *Pumpfix*. This means that the hybrid lifting station is ideally suited to use in commercial buildings and apartment blocks. With a power rating of up to 4.5 kW, the *Ecolift XL* can also reliably pump the wastewater into a flooded sewer. In normal operation, the pump does not run at all and the wastewater simply drains to the sewer via gravity.

The *Ecolift XL* can be installed as a free-standing set-up, in an underground engineering chamber or in a concrete floor slab. It is available with various pump power ratings, a 230 V model and various 400 V models. The variants with one motor-driven closure system are suitable for grey water and those with two for black water.



1 Hybrid lifting station 2 Pressure pipe



1 Hybrid lifting station 2 Pressure pipe



1 Hybrid lifting station 2 Upper section for concrete floor slab



DGNB
SUSTAINABILITY
CHALLENGE
2020
INNOVATION
FINALIST

Chamber covers

Available in a stainless steel class A/L15 (tileable or not tileable) or in load classes B and D

Additional inlet connection

Three areas are available for easy on-site connection of conduit or ventilation pipes

Honeycomb chamber design

Provides additional chamber strength and prevents buoyancy. Additional inlets up to size Ø 160 mm can be installed on-site

Integrated closure valve

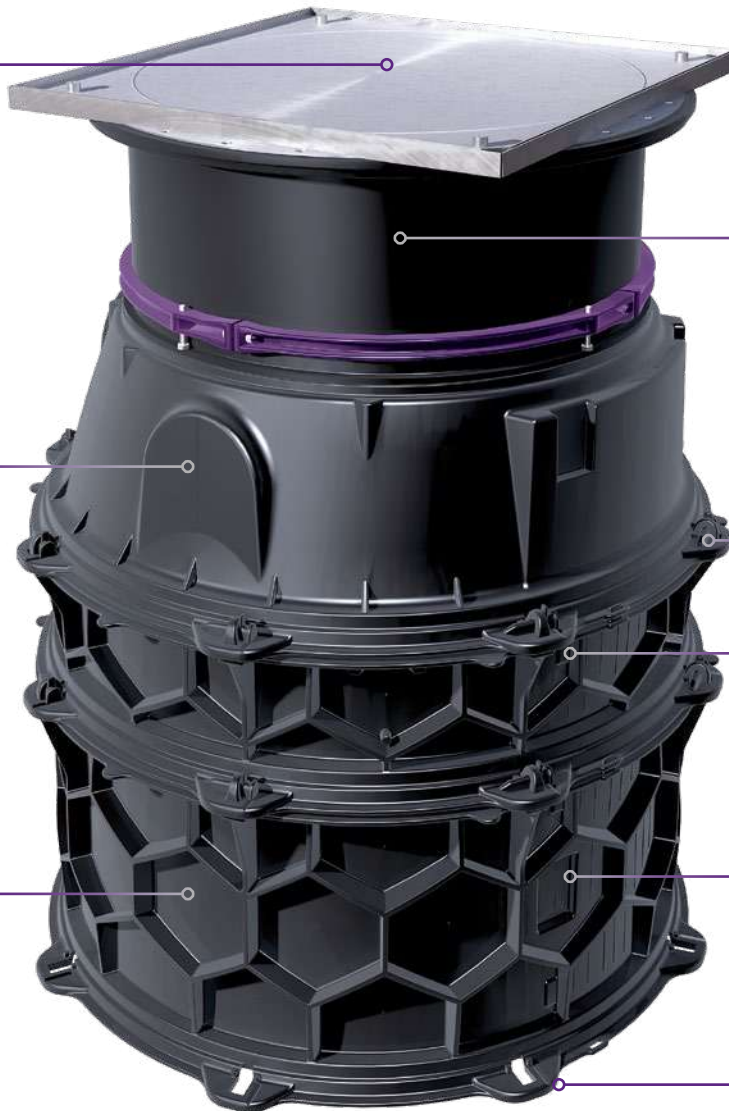
With safety lock to prevent accidental closure

Safety / reliability

Pneumatic level sensing and alarm sensor offer twice the reliability

Sound / vibration decoupling

All active components and the outlet pressure pipe are sound decoupled from the chamber



Vertically adjustable upper section

Available with Ø 600 mm or Ø 800 mm diameter with optional water-proofing connection flange

Connection system

The new chambers allows simple and fully watertight connections of the chamber components

Modular system

Sectional chamber components available in 250 mm and 500 mm heights

Groundwater resistant

For installation in up to 3000 mm of groundwater



Pressure outlet connection

Quick-release, no tools required

Pressure outlet

Ø 90 mm

Backwater flap closure system

Available with up to two motorized backwater flaps for maximum backwater protection

This is how it's done

Planning a hybrid lifting station

Ecolift XL

1 Select a system base with suitable pump power

Always the right choice: 
kessel.com/smartselect

Determine the required pump power (e.g. with the calculation module from SmartSelect) and select the corresponding system base with the help of the power diagram.

➤ System base for minimum installation height:
page 84

➤ System base for free-standing set-up or
installation in ground: page 85

2 Select a system chamber with suitable cover

Depending on the installation situation, when installing underground or in a floor slab, the system chamber can be combined with different upper sections and covers. From class K 3 to class D. In addition, you can also choose between the \varnothing 600 and \varnothing 800 mm chamber access openings.



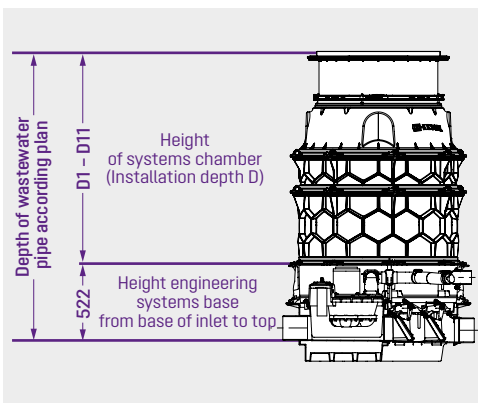
Chamber access opening
 \varnothing 600

Chamber access opening
 \varnothing 800

For \varnothing 600 mm access opening an inlet depth of at least 1.780 mm is required for maintenance. Load Class D applications require a concrete load distribution plate when road construction is not to spec (contact KESSEL for further information).

3 Calculate the height of the system chamber (D)

Now determine the required chamber height. D is the distance between the ground surface and the base of the inlet pipe.



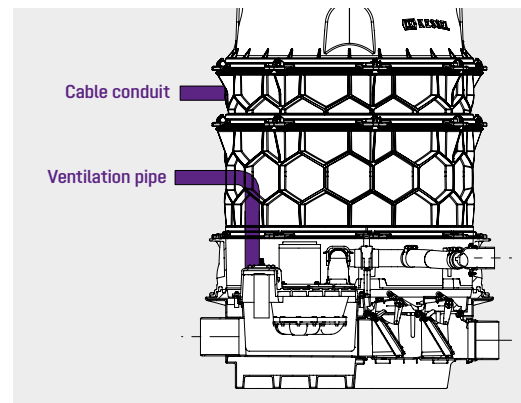
Note: check on-site max groundwater levels

The KESSEL system chambers are resistant to groundwater depths up to 3.000 mm. Now subtract 522 mm from the inlet depth and you have the height of the required engineering chamber. Now you can select a module with the corresponding height and the required cover from the article list. Please note the maximum permissible total installation depth is 5.000 mm.

4 Note: Connection pipe for cables and ventilation

During planning, please also note the following:

- The maximum cable length is 30 m.
- Stipulate that the **ventilation pipe** and the **cable conduit** must be laid with a continuous slope toward the *Ecolift XL* (helps drain collected water in the pipe).



➤ Optional cable conduit sealing kit: page 91

Hybrid lifting station *Ecolift XL Mono / Duo*

Dry installation, for minimum installation depth



Z-53.2-493 ÖNORM B 2501

Base section made of PE. For on the floor installation in frost-free rooms, outdoor underground installation or installation in a concrete floor in combination with upper section see page 83.

Version:

- backwater lifting station *Ecolift XL Mono / Duo* for connection to Ø 800 mm upper sections
- inlet / outlet Ø 160 mm
- with Comfort Plus control unit
- with one motor-driven backwater flap for wastewater without sewage or with two motor-driven backwater flaps (with redundancy control unit) for wastewater with sewage
- 230 V-Versions ready to plug in

Cable length: 10 m

Installation:

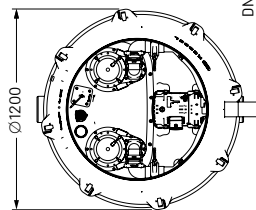
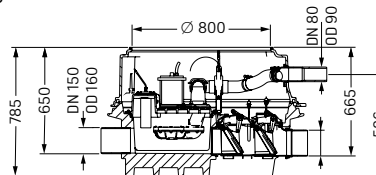
Handles groundwater depths up to 3000 mm

Note:

The pressure pipe must be connected to a welded PE pipe; in the case of pump *SPF 4500* pressure pipe to be connected to a pressure relief chamber (contact KESSEL for questions).

➤ **Installation:** in combination with upper section Ø 800 page 89 – 90

➤ **Accessories:** pages 91 – 93



Mono version with one pump

SPF pump	Voltage	Art. no.
With one motor-driven backwater flap for wastewater without sewage		
1400-S3	230 V	874 10 44
1500-S3	400 V	874 10 45
3000-S3	400 V	874 10 46
4500-S3	400 V	874 10 47

SPF pump	Voltage	Art. no.
With two motor-driven backwater flaps for wastewater with sewage		
1400-S3	230 V	874 10 48
1500-S3	400 V	874 10 49
3000-S3	400 V	874 10 50
4500-S3	400 V	874 10 51

Duo version with two pumps

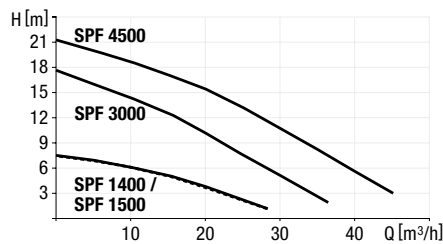
SPF pump	Voltage	Art. no.
With one motor-driven backwater flap for wastewater without sewage		
1400-S3	230 V	874 10 60
1500-S3	400 V	874 10 61
3000-S3	400 V	874 10 62
4500-S3	400 V	874 10 63

1400-S1	230 V	874 10 64
1500-S1	400 V	874 10 65
3000-S1	400 V	874 10 66
4500-S1	400 V	874 10 67

1400-S3	230 V	874 10 68
1500-S3	400 V	874 10 69
3000-S3	400 V	874 10 70
4500-S3	400 V	874 10 71

1400-S1	230 V	874 10 72
1500-S1	400 V	874 10 73
3000-S1	400 V	874 10 74
4500-S1	400 V	874 10 75

Pumping capacity



Pump type

	Voltage	Amperage	Input Power (P1)	Power (P2)	Pumping capacity	H [m] = Backwater height
SPF 1400-S1/S3-100/50%*	230 V	7.3 A	1.6 kW	1.1 kW	28 m³/h	7.5 m
SPF 1500-S1/S3-100/50%*	400 V	2.7 A	1.4 kW	1.1 kW	28 m³/h	7.5 m
SPF 3000-S1/S3-100/50%*	400 V	5.4 A	3.3 kW	2.7 kW	36 m³/h	17.5 m
SPF 4500-S1/S3-100/50%*	400 V	7.5 A	4.5 kW	3.7 kW	45 m³/h	21 m

* Definition of S1 and S3-pumps see page 101



Hybrid lifting station *Ecolift XL Mono / Duo*

Dry installation, free standing or in a concrete slab



Z-53.2-493 ÖNORM B 2501

Base section made of PE
For on the floor installation in frost-free rooms, outdoor underground installation or installation in a concrete floor in combination with an engineering system chamber see pages 85 – 86.

Version:

- backwater lifting station *Ecolift XL Mono / Duo*
- inlet / outlet \varnothing 160 mm
- with Comfort Plus control unit
- with one motor-driven backwater flap for wastewater without sewage or two motor-driven backwater flaps (with redundancy control unit) for wastewater with sewage
- 230 V-Versions ready to plug in

Cable length: 10 m

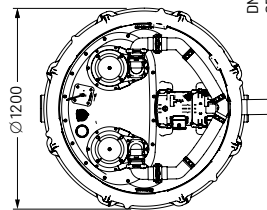
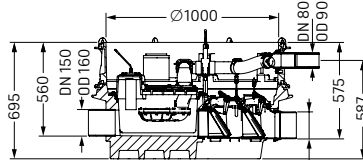
Installation:

Handles groundwater depths up to 3000 mm

Note:

The pressure pipe must be connected to a welded PE pipe; in the case of pump *SPF 4500* pressure pipe to be connected to a pressure relief chamber (contact KESSEL for questions).

- **Installation:** in combination with an engineering system chamber \varnothing 1000 page 89 – 90
- **Accessories:** pages 91 – 93



Mono version with one pump

SPF pump	Voltage	Art. no.
With one motor-driven backwater flap for wastewater without sewage		
1400-S3	230 V	874 10 06
1500-S3	400 V	874 10 07
3000-S3	400 V	874 10 08
4500-S3	400 V	874 10 09

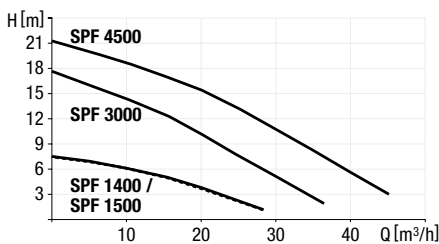
With two motor-driven backwater flaps for wastewater with sewage

1400-S3	230 V	874 10 10
1500-S3	400 V	874 10 11
3000-S3	400 V	874 10 12
4500-S3	400 V	874 10 13

Duo version with two pumps

SPF pump	Voltage	Art. no.
With one motor-driven backwater flap for wastewater without sewage		
1400-S3	230 V	874 10 22
1500-S3	400 V	874 10 23
3000-S3	400 V	874 10 24
4500-S3	400 V	874 10 25
With two motor-driven backwater flaps for wastewater with sewage		
1400-S1	230 V	874 10 26
1500-S1	400 V	874 10 27
3000-S1	400 V	874 10 28
4500-S1	400 V	874 10 29

Pumping capacity



Pump type

	Voltage	Amperage	Input Power (P1)	Power (P2)	Pumping capacity	H [m] = Backwater height
SPF 1400-S1/S3-100/50%*	230 V	7.3 A	1.6 kW	1.1 kW	28 m³/h	7.5 m
SPF 1500-S1/S3-100/50%*	400 V	2.7 A	1.4 kW	1.1 kW	28 m³/h	7.5 m
SPF 3000-S1/S3-100/50%*	400 V	5.4 A	3.3 kW	2.7 kW	36 m³/h	17.5 m
SPF 4500-S1/S3-100/50%*	400 V	7.5 A	4.5 kW	3.7 kW	45 m³/h	21 m

* Definition of S1 and S3-pumps see page 101



Hybrid lifting station *Ecolift L*

The intelligent alternative to a lifting station



The *Ecolift L* is the reliable drainage solution that pumps against backwater. Whether for the disposal of wastewater with sewage in a multi-dwelling building or the downstream of wastewater without sew downstream of the grease separator of a large kitchen: *The Ecolift L* does the job reliably. As in commercial use interruptions due to pump failure must be avoided, the system is also available as a Duo version with two pumps. That makes it the perfect back-water pumping station for larger projects.



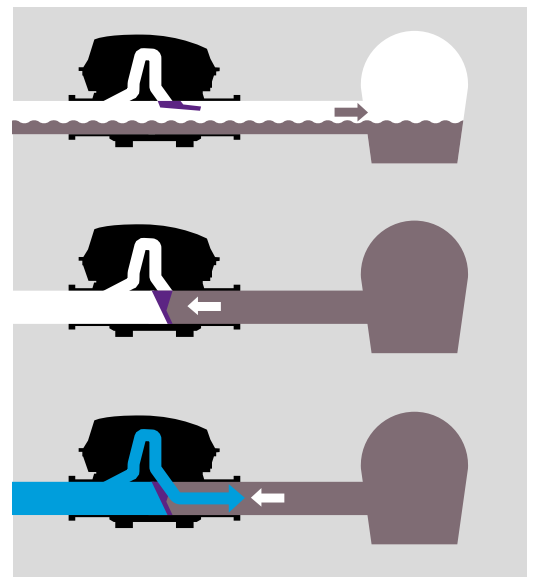
1 Hybrid lifting station 2 Control unit



1 Hybrid lifting station 2 Grease separator

How it works

In normal operation it uses the natural slope to the sewage pipe. In the event of backwater from the sewage pipe, the pump is automatically switched on in order to reliably pump the building's wastewater into the flooded sewer by using a bypass.



Hybrid lifting station *Ecolift L Bypass Mono / Duo* for wastewater with and without sewage



Wastewater with and without sewage for installation in an exposed drainage pipe, draining via the gravity pipe to the sewer. Lifting function with one or two pumps, only for backwater flap that can be closed by a motor in the event of backwater, with an additional hinged flap or, depending on the version, with two hinged flaps. During the backwater phase the water drains via a bypass system that is connected via a pressure pipe. Including backwater preventer and shut-off valve for the pressure pipe. DN 70 opening for on-site ventilation pipe. Incl. probe protected against wire break for detection of backwater.

Depending on the version, control unit(s) with integrated self-diagnosis system (SDS), display of the operating states and integrated battery back-up for alarm signals. User-friendly menu guidance in multi-line display. With self-diagnosis system (SDS) and reminder when maintenance is due. Display of current measured values. Simple adjustment of the function-related parameters, including operating hour meter and potential-free contact. Optional relaying of alarm and collective error messages via GSM interface. Control unit with full text display in six languages. Outlet pressure pipe ABS DN 50 (OD=63mm) SDR17. Mono or Duo system with pump type SPF multi-vane vortex impeller 1350-S3 50% with a free passage of 40 mm. With one motorised backwater flap (FKA version) or two self-closing flaps (SWA version).

- Nominal frequency:** 50 Hz
- Fuse:** 1 x 16 A slow-blow
- Type of protection (pump):** IP 68 (3mWC/48h)
- Operating mode:** S3 (50% on period)
- Motor:** IP 68
- Connection drainage pipe:** DN 150
- Type of installation:** exposed drainage pipe
- Control unit:**
- Control cable / cable length:** 1 m
- Mains voltage / frequency:** 230 V AC / 50 HZ
- Control unit (IP 54):** Comfort control unit upgradable for remote maintenance

- **Accessories:** page 93
- **Note:** Approval applied for

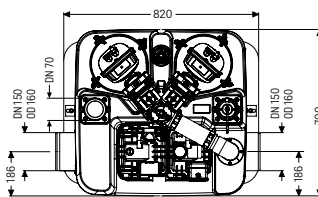
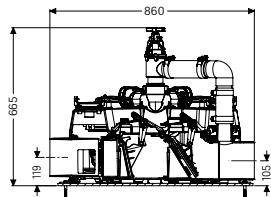


Illustration shows *Ecolift L Duo FKA*

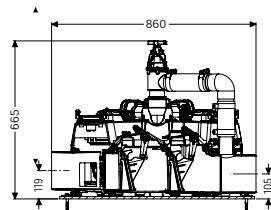


Illustration shows *Ecolift L Duo SWA*

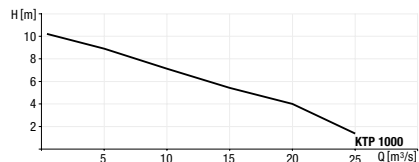
With one motorised flap for wastewater with or without sewage

System	L x H in mm	Art. no.
Mono	860 x 700	22 006
Duo	860 x 700	22 007

With two self-closing flaps for wastewater without sewage

System	L x H in mm	Art. no.
Mono	860 x 700	22 004
Duo	860 x 700	22 005

Pumping capacity



H [m] = Backwater height

Pump type	Voltage	Amperage	Input Power (P1)	Power (P2)	Pumping capacity	H [m] = Backwater height
SPF 1350-S3/50%*	230 V	6 A	1.35 kW	0,8 kW	26 m³/h	10 m

* Definition of S1 and S3-pumps see page 101

Upper section Ø 800

Made of polymer / stainless steel

Compatibility:

For use as upper section for the engineering system base *Ecolift XL Mono/Duo* for the version with minimum installation depth page 82

Version:

with / without waterproof flange

square, tileable,
without waterproof flange



Installation depth D
in mm (min./max.)

Covers

Art. no.

65 - 314

Class A/L 15

874 01 75

square, tileable,
with waterproof flange



282 - 531

Class A/L 15

874 01 76

square, not tileable,
without waterproof flange



50 - 299

Class A/L 15

874 01 77

square, not tileable, anti-slip,
with waterproof flange



267 - 516

Class A/L 15

874 01 78

square, without waterproof
flange



274 - 523

Class B

874 01 79

274 - 523

Class D

874 01 80

round, without waterproof
flange



65 - 314

Class K 3

874 01 81

Engineering system chamber Ø 1000 with access opening Ø 600

for combination with hybrid lifting station *Ecolift XL*

EN 13598 Part 2 Z-42.1-527

Made of polyethylene PE-HD

Installation: For underground installation; handles groundwater depths up to 3000 mm

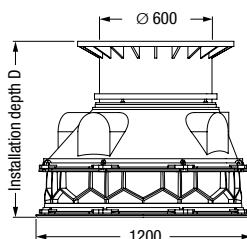
Modular design comprising:

- Chamber rings with access steps fitted
- With telescopic height adjustable upper section
- Round cover made of cast iron
- Includes all sealing gaskets and wedge connectors required for installation

Delivery: As individual elements

Remark: Covers surface water tight

Note: Additional installation depths (on request)



Installation depth D in mm Art. no.

Class A/B

1130 - 1379	874 00 18
1380 - 1629	874 00 24
1630 - 1879	874 00 30
1880 - 2129	874 00 36
2130 - 2379	874 00 42
2380 - 2629	874 00 48
2630 - 2879	874 00 54
2880 - 3129	874 00 60

Class D

1130 - 1379	874 00 19
1380 - 1629	874 00 25
1630 - 1879	874 00 31
1880 - 2129	874 00 37
2130 - 2379	874 00 43
2380 - 2629	874 00 49
2630 - 2879	874 00 55
2880 - 3129	874 00 61

Engineering system chamber Ø 1000 with access opening Ø 800

for combination with hybrid lifting station *Ecolift XL*

EN 13598 Part 2 Z-42.1-527

Made of polyethylene PE-HD

Installation: For installation in the concrete slab; handles groundwater depths up to 3000 mm

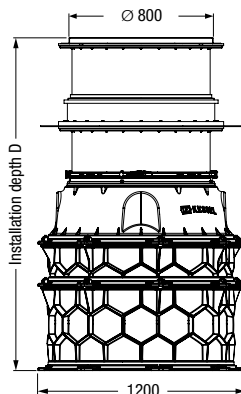
Modular design comprising:

- For waterproof concrete with flange and counter flange
- Chamber rings with access steps fitted
- With telescopic height adjustable upper section
- Square cover made of stainless steel, class A/L 15 or round cover in class K 3
- Includes all sealing gaskets and wedge connectors required for installation

Delivery: As individual elements

Remark: Covers surface water tight

Note: Additional installation depths, upper sections and covers class B/D (on request)



Cover tileable, square

Installation depth D in mm Art. no.

668 - 917	874 00 03
918 - 1167	874 00 09
1168 - 1417	874 00 15
1418 - 1667	874 00 21
1668 - 1917	874 00 27

Cover not tileable, square, anti-slip

Installation depth D in mm Art. no.

653 - 902	874 00 05
903 - 1152	874 00 11
1153 - 1402	874 00 17
1403 - 1652	874 00 23
1653 - 1902	874 00 29

Cover not tileable, round

Installation depth D in mm Art. no.

638 - 887	874 02 22
888 - 1137	874 02 23
1138 - 1387	874 02 24
1388 - 1637	874 02 25
1638 - 1887	874 02 26

Engineering system chamber Ø 1000 with access opening Ø 800

for combination with hybrid lifting station *Ecolift XL*

EN 13598 Part 2 Z-42.1-527

Made of polyethylene PE-HD

Installation: For underground installation; handles groundwater depths up to 3000 mm

Modular design comprising:

- Chamber rings with access steps fitted
- With telescopic height adjustable upper section
- Covers made of stainless steel
- Includes all sealing gaskets and wedge connectors required for installation

Delivery: As individual elements

Remark: Covers surface water tight

Note: Additional installation depths, upper sections and covers class B/D (on request)



Illustration shows Art. no. 874 01 43



Illustration shows Art. no. 874 00 20

Illustration shows Art. no. 874 01 22

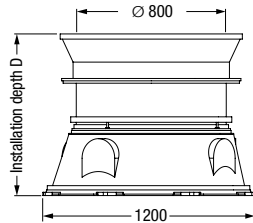


Illustration shows Art. no. 874 01 58

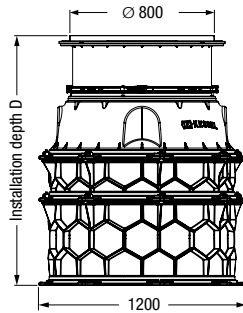


Illustration shows Art. no. 874 00 02

Round cover

Installation depth D in mm Art. no.

Class K 3

375 - 624	874 01 22
625 - 874	874 01 23
875 - 1124	874 01 24
1125 - 1374	874 01 25
1375 - 1624	874 01 26
1625 - 1874	874 01 27
1875 - 2124	874 01 28
2125 - 2374	874 01 29
2375 - 2624	874 01 30
2625 - 2874	874 01 31
2875 - 3124	874 01 32

Square cover

Installation depth D in mm Art. no.

Class B

620 - 869	874 01 41
870 - 1119	874 01 42
1120 - 1369	874 01 43

Class D

620 - 869	874 01 58
870 - 1119	874 01 59
1120 - 1369	874 01 60

Square cover

Installation depth D in mm Art. no.

Class A/L 15, not tileable, anti-slip

396 - 645	874 00 04
646 - 895	874 00 10
896 - 1145	874 00 16
1146 - 1395	874 00 22
1396 - 1645	874 00 28
1646 - 1895	874 00 34
1896 - 2145	874 00 40
2146 - 2395	874 00 46
2396 - 2645	874 00 52
2646 - 2895	874 00 58
2896 - 3145	874 00 64

Class A/L 15, tileable

411 - 660	874 00 02
661 - 910	874 00 08
911 - 1160	874 00 14
1161 - 1410	874 00 20
1411 - 1660	874 00 26
1661 - 1910	874 00 32
1911 - 2160	874 00 38
2161 - 2410	874 00 44
2411 - 2660	874 00 50
2661 - 2910	874 00 56
2911 - 3160	874 00 62

Accessories

Engineering systems base *Ecolift XL*

Extension section

			Art. no.
500 mm	Compatibility: Engineering systems base <i>Ecolift XL</i> Inclusive: 2 access steps, installed Note: Without gasket and connecting wedges		680 371
250 mm	Compatibility: Engineering systems base <i>Ecolift XL</i> Inclusive: 1 access step, installed Note: Without gasket and connecting wedges		680 370

Gasket / Connection and attachment set

			Voltage	Art. no.	
Cable piping gasket set	Compatibility: Control unit 230 V and 400 V		in the building	230 V	85 401
			in the building	400 V	85 402
			in the chamber	230 V	85 403
			in the chamber	400 V	85 404
Set of connecting wedges	Compatibility: Art. no. 680 371 and 680 370 Set-content: 10 pieces			680 373	
Profiled gasket	Compatibility: Art. no. 680 371 and 680 370			680 125	
Cable attachment set	Compatibility: Engineering systems base Ø 1000 Set-content: 3 pieces of clamps			28 076	

GSM-Communication

			Art. no.
TeleControl telemetric system	Compatibility: For connection to KESSEL Comfort control units 230 Volt and 400 Volt Function: Relaying of full text messages to up to three mobile phones Inclusive: With internal antenna (without SIM card)		28 792
Antenna booster with magnetic base	Compatibility: For <i>TeleControl</i> telemetric system to improve the reception Cable length: 2.5 m		28 793
Extension cable	Compatibility: For antenna booster Cable length: 2 m		28 794

Level sensor

			Cable length	Art. no.
Level sensor with immersion pipe 181 mm	Compatibility: For <i>Ecolift XL</i>		10 m	681 046
			30 m	681 047



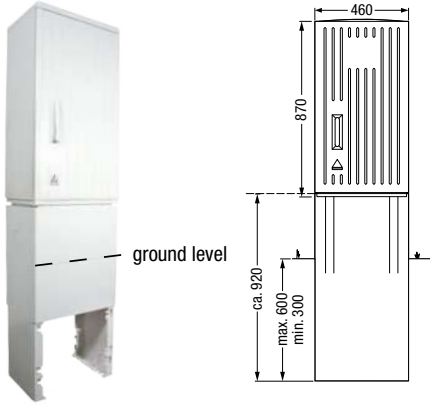
Accessories

Engineering systems base *Ecolift XL*

Outside installation:

Outdoor control cabinet, warning beacon, thermostat/Hygrostat




for installation of control units, modems, heating element, warning beacon outside of buildings

			Height over all in mm	Width / depth in mm	Art. no.
Warning beacon	Function: For the additional visual display of faults, for installation on the outdoor control cabinet, with switching unit for connection to the control unit				97 715
Installation set Thermostat / Hygrostat	Function: As an additional module for installation in the outdoor kiosk to reduce condensation				97 713
for control unit, heating, warning beacon	Height over ground level: 870 mm		1740	460/320	97 716
for heating and pressure pipe	Height over ground level: 870 mm		1740	590/320	97 714
for control unit, modem, heating, warning beacon	Height over ground level: 870 mm		1740	785/320	97 723
for control unit, modem, heating, warning beacon and pressure pipe	Height over ground level: 870 mm		1790	1115/320	97 724

- Note:**
- factory cut holes available on request: info@kessel.com
 - for additional custom solutions please see Lifting Stations chapter of this catalogue.
 - if the Outdoor Control Cabinet is exposed to direct sunlight, it is recommended that an optional cooling system is installed

Distance > 10 m to control unit: Cable extensions, air compressor

for extension from 20 m or 30 m (*Ecolift XL* cable length 10 m)

	Hybrid lifting station <i>Ecolift XL</i> with one motor-driven backwater flap	Hybrid lifting station <i>Ecolift XL</i> with two motor-driven backwater flaps		Art. no.
Cable extension for flap motor(s) (10 m)	Extension to 20 m: 1×80 890 Extension to 30 m: 2×80 890	Extension to 20 m: 2×80 890 Extension to 30 m: 4×80 890		80 890
Cable extension for probe(s) (10 m)	Extension to 20 m: 2×80 889 Extension to 30 m: 4×80 889	Extension to 20 m: 3×80 889 Extension to 30 m: 6×80 889		80 889
Cable extension for pump <i>SPF 1400 S1/S3</i> (10 m)	Extension to 20 m: 1×80 891** Extension to 30 m: 2×80 891**	Extension to 20 m: 2×80 891** Extension to 30 m: 4×80 891**		80 891
	** 400 V extension on-site through qualified electrician			
Air compressor	Function: For use in combination with lifting station and pumping stations with pressure control: prevents soiling, avoids the formation of condensate in the pressure hose, makes operation of systems possible with pressure hose lengths > 10 m – 30 m Inclusive: T-piece connection, 20 m pressure hose			28 048
PE-pressure hose extension (per meter)	Compatibility: For Art. no. 28 048			680 071

Accessories

Engineering systems base *Ecolift XL*

Peltier cooler set

Art. no.

Peltier cooler set

Compatibility: For horizontal mounting on KESSEL outdoor control cabinets
Inclusive: Mains adapter, thermostat

681 148

GSM-Communication

Art. no.

Audible alarm

Compatibility: For all control units with SDS function
Cable length: 20 m



20 162

Accessories

Hybrid lifting station *Ecolift L*

Wall bracket

Art. no.

Wall bracket

For setting up the installation in a higher position to make it easier to achieve a "free gradient" for gravity flow to the sewer. Fixed on the wall with mounting brackets.



22 200

Conversion kit for second pump

Art. no.

Conversion kit

Conversion kit for changing from a Mono to a Duo system. Including cable and connection to the pressure pipe connection. Pump type SPF multi-vane vortex impeller 1350-S3 50% with a free passage of 40 mm. With Duo Control Unit



22 201

Level probe

Art. no.

Level probe

Level probe conversion kit 5 m, Conversion kit consisting of level probe.



22 203

Activated carbon filter

Art. no.

Activated carbon filter

For ventilation of the installation if a ventilation pipe cannot be laid. Activated carbon filter with replaceable cartridge with activated carbon. Compatible with DN 70 pipes.
Material: polymer
Activated carbon dimensions: Height: 50 mm, Diameter: 90 mm
 Air balancing 6l/sec.
 Including non-return ball. The activated carbon unit should be replaced every 6 months to ensure functions properly.



22 202

Optical alarm probe

Art. no.

Optical alarm probe

Optical probe, incl. adapter and protective pipe.
Probe protection rating: IP 68 (3m/48h)
Control cable: 5 m



22 205

Outdoor control cabinet

preassembled version; with factory-mounted system components

Material: Glass-fibre reinforced polyester

Version includes:

- standard cabinet with profiled surface
- open floor
- three-point locking with swivel handle
- with Euro lock cylinder
- door opening angle 180°

Protection rating: IP44

Colour: RAL 7035

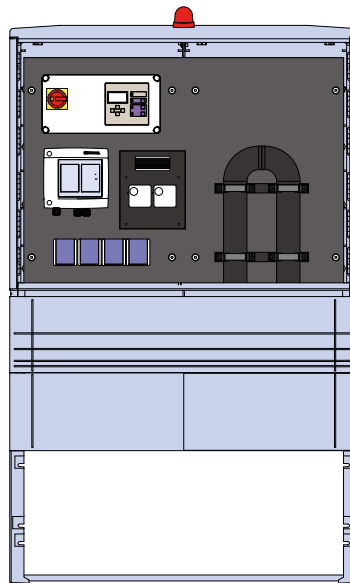


Illustration shows Example for Aqualift S/F

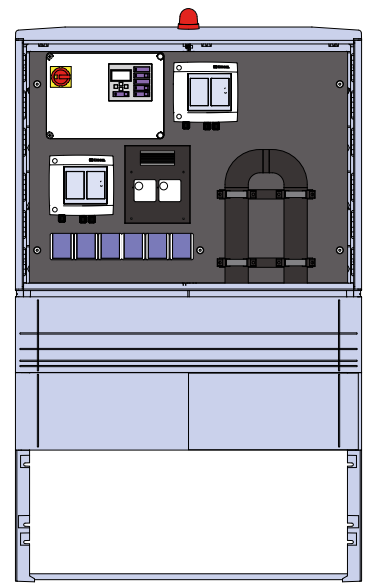
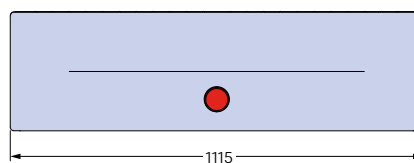
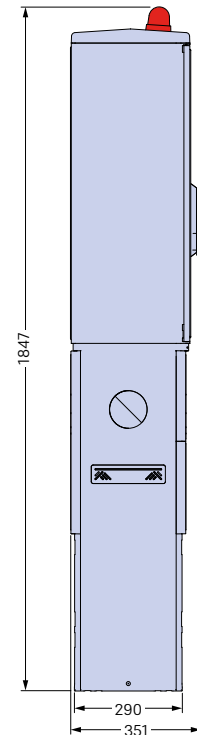
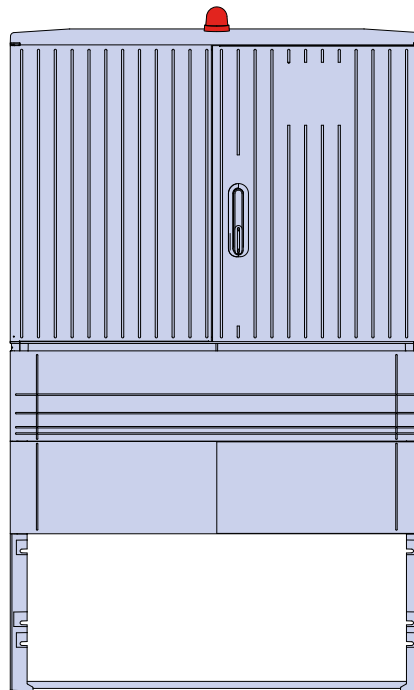


Illustration shows Example for Ecolift XL

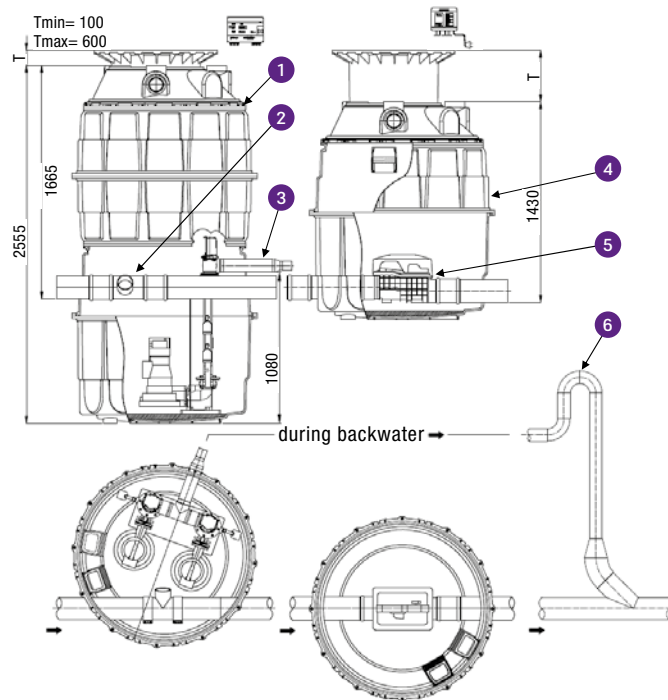


Hybrid pumping station individual solution

with overflow channel and backwater valve *FKA*



Polyethylene PE-HD. For wastewater with or without sewage, for underground installation, made of polyethylene PE-HD with access steps, watertight, resistant against aggressive wastewater. Polymer upper section for continuous height and level compensation, cover plate made of cast iron according to EN 124. Connection hole with sealing gasket Ø 110 in accordance with EN 1401 and EN 12666-1 for ventilation and cable conduits respectively, pump volume approx. 200 l. Pressure pipe pre-assembled with backwater flap, closure valve and 4 float switches for level control. Two submersible pumps (available with or with ATEX explosion protection), with cutting unit for pumping wastewater with and without sewage, flood-proof. Electric control unit for fully automatic pump control, splashwater-proof, for wall mounting in dry, frost-free areas of the building, with potential-free contact.



Hybrid lifting stations

2.2

Function

Standard operation

In standard operation, the connected drainage fixtures can drain by means of natural gravity through the open channel to the sewer.

Backwater protection

If there is any backwater from the sewer, the sensor system in the backwater valve *Staufix FKA* detects backwater in the drain pipe and closes the motor-driven flap, protecting the building.

Disposal during the backwater phase

Any wastewater from the building which occurs during this phase pours through the overflow opening into the pumping station. After sufficient wastewater is collected the pump(s) activate and discharge the building's wastewater into the flooded sewer.

Standard operation

After backwater the backwater valve *Staufix FKA* automatically re-opens, the connected drainage fixtures can be drained through the open channel again.

- 1 Pumping station *Aquapump Retrofit*
- 2 Channel passage with overflow opening
- 3 Outlet for pressure pipe
- 4 Chamber system *Komfort* Ø 1000
- 5 Backwater valve *Staufix FKA* for wastewater with/without sewage
- 6 Loop via backwater level

Chamber system	Comfort Ø 1000
Standard	EN 752
Installation depth in mm	**
Inlet depth in mm	**
Inlet passage channel with overflow opening	**
Pressure socket (DN)	Ø 63 mm / Ø 90 mm
Type of cover	unscrewed
Load class	B 125 (12.5 t)

	<i>Aquapump</i> (Duo system)	<i>Aquapump</i> (Duo system)
Pumping station	TPF 1.3 KE	TPF 1.9 KE
Pump type	TPF 1.3 KE	TPF 1.9 KE
Standard	EN 12050-1	EN 12050-1
Feed rate	max. 15 m ³ /h	max. 20.5 m ³ /h
Pumping height	max. 17.5 m	max. 32.0 m
Rated power	2 × 1.3 kW	2 × 1.9 kW
Input power	2 × 1.75 kW	2 × 2.6 kW
Operating voltage	400 V DC	400 V DC
Rated frequency	50 Hz	50 Hz
Rated current	3.5 A	4.5 A
Fuse protection	3 × 16 A slow-blow	3 × 16 A slow-blow
Protective rating (pumps)	IP 68 EX-protection	IP 68 EX-protection
Protective rating (control unit)	IP 54	IP 54
Cable length	10 m (7 × 1.5 mm ²)	10 m (7 × 1.5 mm ²)

** Please enter the desired values

3. Lifting and Pumping stations

For wastewater with and without sewage

Overview of Range of lifting stations and pumps

If gravity drainage
to the sewer is
available:
➔ Hybrid lifting stations:
Page 64

3.1 Lifting stations



Lifting station
Aqualift F XL

➔ Page 111



Lifting station
Aqualift S 100 / 200

➔ Page 123



Lifting station
Aqualift F

➔ Page 114



Lifting station
Aqualift S Compact

➔ Page 127



Lifting station
Aqualift F Basic

➔ Page 117



Lifting station
Minilift S

➔ Page 132



New



Lifting station
Aqualift F Compact

















➔ Page 119



Compact lifting station
Minilift F

➔ Page 121

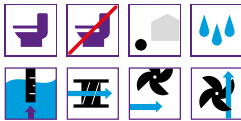


Type of wastewater	Wastewater quantity	Level sensors
 Wastewater with sewage	 Low	 Pressure sensor
 Wastewater without sewage	 Medium	 Conductance probe
	 High	 Float switch
Installation situation	Pump types	 Level sensor
 Outdoor, underground installation	 Macerator	 Optical probe
 Indoor, on-the-floor installation	 Multi-vane	
 Floor slab installation	 Single-channel	

3.2 Pumping stations



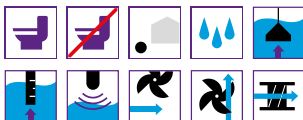
Pumping station
Aquapump XXL
➤ Page 147



Conversion kits for collecting tanks
Aquapump Retrofit
➤ Page 165



Pumping station
Aquapump XL
➤ Page 149



3.3 Submersible pumps, conversions and control units



Submersible pump
Aquadive GTF
➤ Page 174



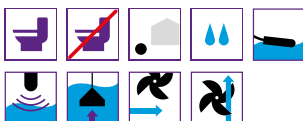
Pumping station
Aquapump XL Basic
➤ Page 155



Submersible pump
Aquadive STZ
➤ Page 174



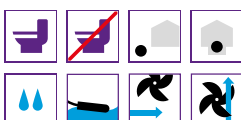
Pumping station
Aquapump Medium
➤ Page 160



Submersible pump
Aquadive KTP
➤ Page 175



Pumping station
Aquapump Small
➤ Page 163

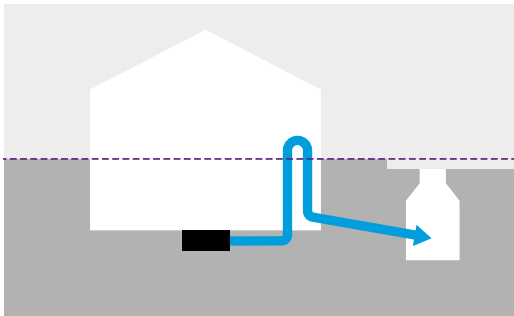


Warning and control units
➤ Page 176

Everything specialists need to know

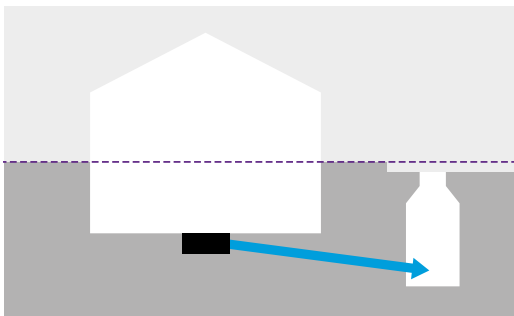
Location of sewer

If the sewage is higher than the drainage point, the wastewater must be lifted to the sewer with a lifting station via a backwater loop.



No slope to the sewer

↗ Lifting stations: page 106

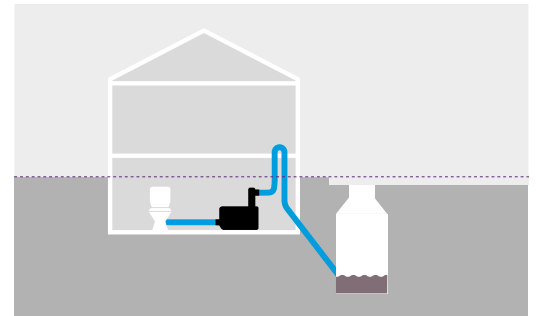


Slope to the sewer

↗ Hybrid lifting stations: page 66

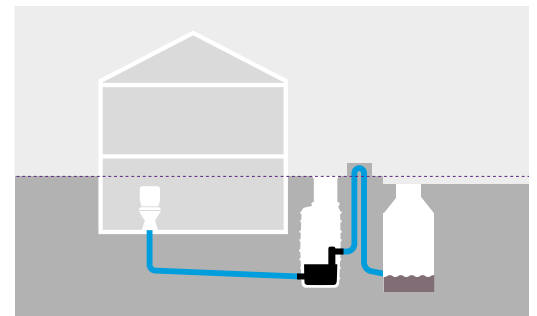
Installation locations

Is your system to be installed inside or outside the building?



Inside the building

↗ Lifting stations: page 106



Outside the building

↗ Pumping stations: page 142

Protection strategy

Individual protection

Each drainage location, such as washbasins, showers or washing machines, is protected with its own backwater protection.

Central protection

Backwater valves or lifting stations installed in the main wastewater pipe, protecting all drainage fixtures.

Types of wastewater

The particle size of a pump specifies how many millimetres of free passage through the pump are available.



Lifting stations for water with sewage

EN 12050-1

Wastewater with sewage is involved whenever pipes are connected that transport water from urinals or toilets to the sewer. This is termed "black water".

Maximum particle size: 40 mm



Lifting stations for water without sewage

EN 12050-2

Wastewater without sewage is water without faecal content, for example shower water or water from a washing machine. This is termed "grey water".

Maximum particle size: 10 mm

Explosion protection



Accidents or spills could result in hazardous liquids entering the lifting station which could result in an explosion risk environment. If the possibility is real, an ATEX explosion protected pumping system should be used.

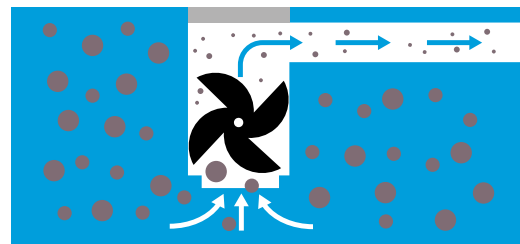
Pump operation classification

KESSEL pumps are classified as S1 or S3 operating duty.

An S1 class pump is a continuous duty pump designed to run without interruption, ideal for rainwater applications or for a continuous industrial wastewater flow.

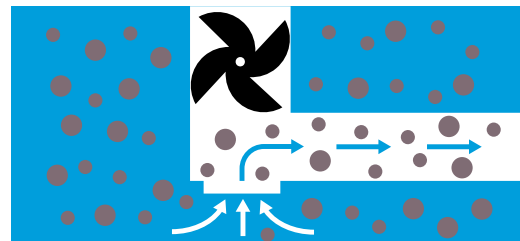
S3 operating duty pumps are intermittent duty and require periodic breaks to stop and cool down. An S3 50% classified pump, for example, should not run more than 50% of the time and are perfect for standard wastewater from homes, apartments or commercial buildings.

Pump types



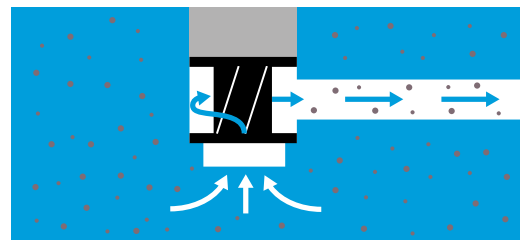
Macerator pumps are especially designed for wastewater containing raw sewage.

These systems cut the wastewater into small particles which allows connection to small diameter pressure pipes.



Multi-vane impeller pumps are designed for wastewater with or without raw sewage.

A large area inside the pump allows any solids to freely pass into the properly sized pressure pipe without contacting the impeller.

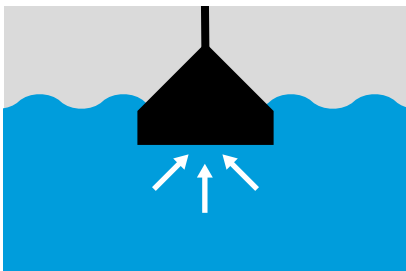


Single-channel impeller pumps are especially designed for solids free or small particle wastewater.

The impeller design efficiently moves high volumes of wastewater with minimal power consumption.

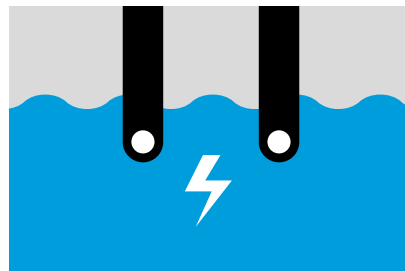
Level sensors / probes and alarm probes

Level sensors and probes measure the level of the pumping medium in the collecting tank of a lifting station and trigger the pumping process of one or more pumps. If the level in the collecting tank continues to rise, an acoustic alarm signal can be given via an alarm probe (which also measures the level of the pumping medium).



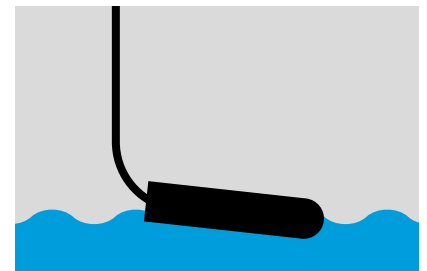
Pressure sensor

Activates based on changes in air pressure resulting from rising or falling water levels in the tank. Unsuitable for applications when the pumps are very far away from the control unit or if condensation build up in the pressure tube is an issue.



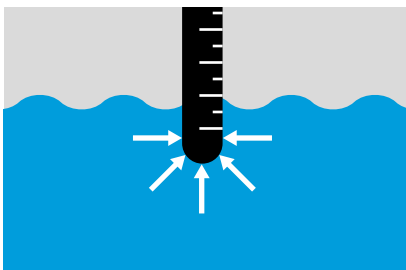
Conductance probe

Activated when a conductive fluid permits current flow between two measuring points – simple and low-cost, but only works with conductive fluids and cannot be used for pumping rainwater or condensate.



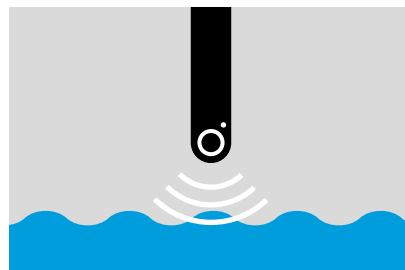
Float switch

Actuated by a float swimming on the pumping medium's surface – simple and proven, but not recommended for heavily soiled wastewater, as material deposits on the float can interfere with level measurement.



Hydrostatic sensor

Based on the conversion of different water pressure values to analogue signals – can be used to measure both alarm and pumping levels with a single sensor, but usually costs more than other sensors and probes.



Optical probe

Detects moisture on the sensor surface by monitoring the refraction angle of an infrared signal – ideal as an alarm probe as it works reliably even after long periods of inactivity, but can be triggered by mistake when wastewater is warm or heavily foaming.

Telemetric system – *TeleControl*

The KESSEL *TeleControl* system allows pump activity, messages or errors to be sent via a GSM interface to up to three mobile phones. This keeps the pump operator informed about the current operational status of the lifting station and allows a quick reaction time if required.



Illustration shows Art. no. 28 792



Operator/owner

Receives a weekly message with the operational status of the lifting station.



Facility manager

Receives all pump actions, messages and errors and is always kept up-to-date with the status of the lifting station.



Plumber

Receives all error messages and can decide if and when an on-site inspection of the system is required.

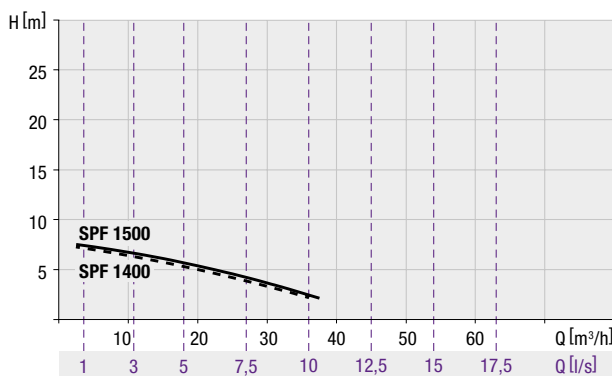
Specification pump drives

SPF 1500, SPF 3000, SPF 4500 and SPF 5500

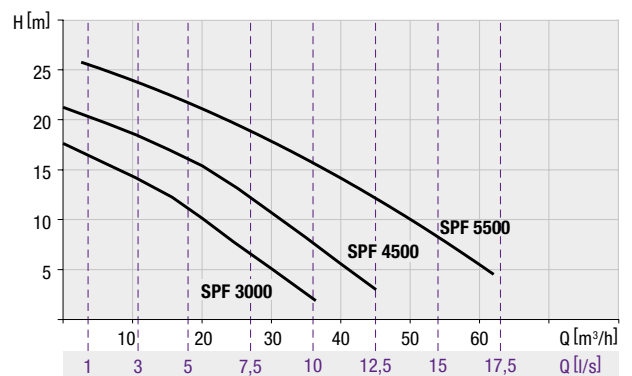


Pump type	Pump drive SPF 1500	Pump drive SPF 3000	Pump drive SPF 4500	Pump drive SPF 5500
Weight	24 kg	24 kg	26 kg	38 kg
Voltage	400 V	400 V	400 V	400 V
Frequency	50 Hz	50 Hz	50 Hz	50 Hz
Electric power P1	1,4 kW	3,2 kW	4,5 kW	5,7 kW
Mechanical power P2	1,1 kW	2,7 kW	3,7 kW	4,7 kW
Nominal current	2,7 A	5,4 A	7,5 A	9,1 A
Speed of rotation	1700 rpm	3400 rpm	3400 rpm	3400 rpm
Operating mode	S1 - 100% / S3 - 50%	S1 - 100% / S3 - 50%	S1 - 100% / S3 - 50%	S3 - 30%
Protection class	I (protective earth)	I (protective earth)	I (protective earth)	I (protective earth)
Protection type	IP68 (5 mWS / 72 h)	IP68 (5 mWS / 72 h)	IP68 (5 mWS / 72 h)	IP68 (5 mWS / 72 h)
Type of cable	H07RN-F7G1,5	H07RN-F7G1,5	H07RN-F7G1,5	H07RN-F7G1,5
Length of cable	5 m*	5 m*	5 m*	5 m*
Medium temperature	40 °C	40 °C	40 °C	40 °C
Maximum head of delivery	8 m	16 m	20 m	27 m
Maximum flow rate	40 m³/h	47 m³/h	55 m³/h	60 m³/h
Impeller type	Multi-vane impeller	Multi-vane impeller	Multi-vane impeller	Multi-vane impeller
Material impeller	Cast iron (GG20)	Cast iron (GG20)	Cast iron (GG20)	Cast iron (GG20)
Material housing	Cast iron and aluminium	Cast iron and aluminium	Cast iron and aluminium	Cast iron and aluminium
Shaft sealing	2x Rotary shaft seal	Mechanical seal SiC/SiC	Mechanical seal SiC/SiC	Mechanical seal SiC/SiC
Insulation material class	F (155 °C)	F (155 °C)	F (155 °C)	F (155 °C)
Thermal engine protection	Yes	yes	Yes	Yes
Starting frequency	20 starts/hour	20 starts/hour	20 starts/hour	20 starts/hour

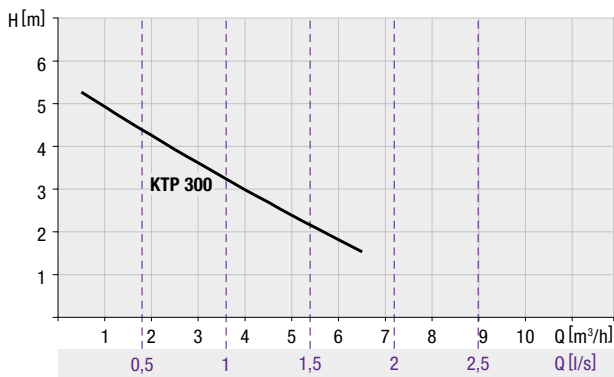
* Underground installation: 10m



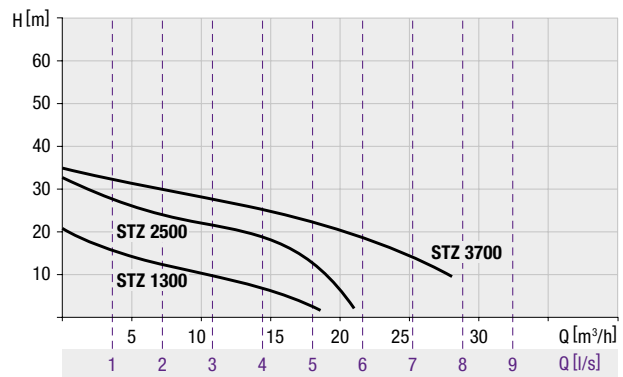
Pump SPF 1400 and SPF 1500



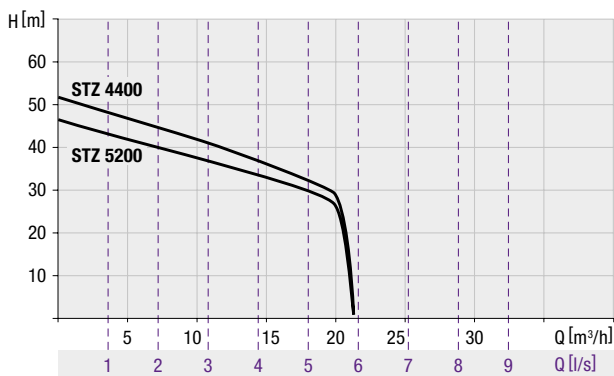
Pump SPF 3000, SPF 4500 and 5000



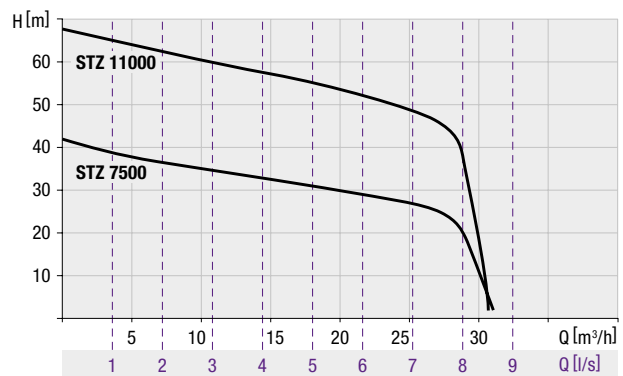
Pump KTP 300



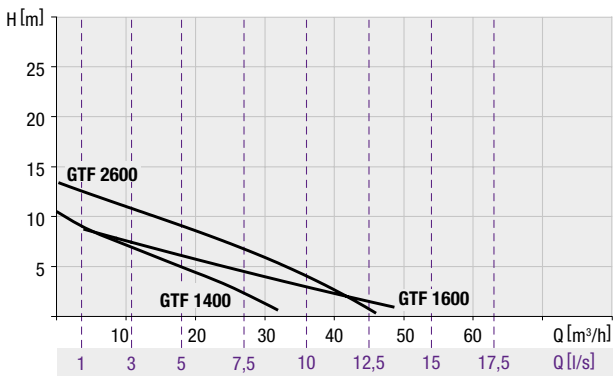
Pump STZ 1300, STZ 2500 and STZ 3700



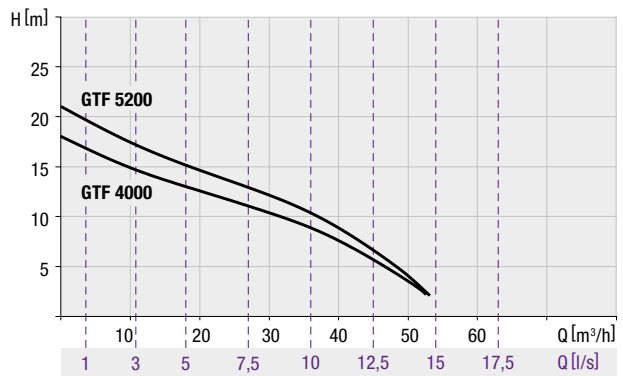
Pumpe STZ 4400 und STZ 5200



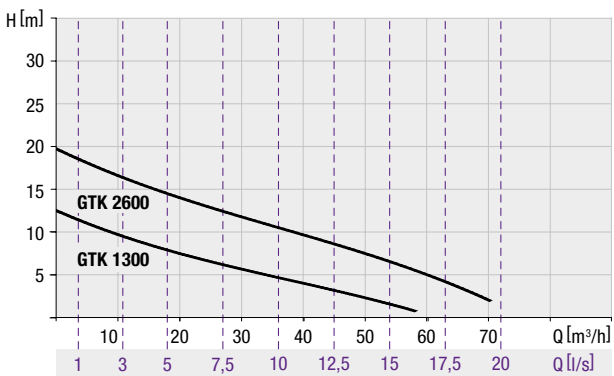
Pumpe STZ 7500 und STZ 11000



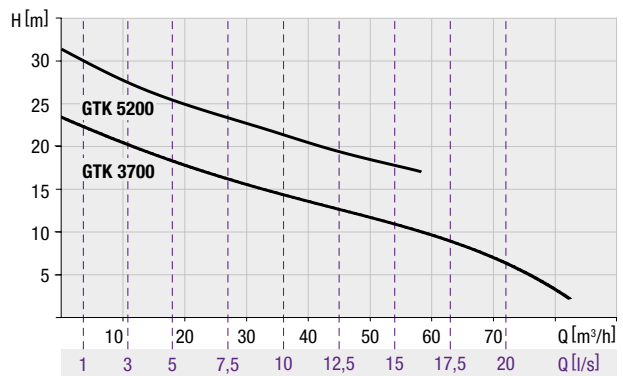
Pumpe GTF 1400, GTF 1600 und GTF 2600



Pumpe GTF 4000 und GTF 5200



Pumpe GTK 1300 und GTK 2600



Pumpe GTK 3700 und GTK 5200

3.1 Lifting stations

For indoor installation



Lifting station *Aqualift F / F XL*

The powerful choice for commercial, industrial and communal applications.

The *Aqualift F / F XL* are powerful lifting stations for domestic, commercial, industrial and communal applications. They are ideal for lifting rainwater that occurs below the backwater level or for use after a separator. However, they can also be used for wastewater with sewage. All components, such as tanks and pumps, are modular in design and can be used in any combination.

The *Aqualift F / F XL* can be combined with six different tanks with a capacity of 50, 120, 200, 300, 450 or 900 liters. It is also available with pumps in different capacity classes and as a Mono or Duo system for different requirements.

The *Aqualift F* systems with 50 and 120 liter tanks are perfect for domestic use and the larger *Aqualift F XL* series with tank volumes up to 900 liters and more powerful pump are designed for use in commercials, industrial and communal applications.

Always the right choice:
kessel.com/smartselect



1 Lifting station 2 Grease separator *EasyClean*

Lifting stations 60 Hz/400 V

Now also available in 60 Hz for more information contact us at info@kessel.com



Pressure sensor

The *Aqualift F* operates with a highly reliable pressure switch for pneumatic level measurement. An optionally available alarm sensor guarantees additional safety.

Powerful pumps and control unit

The *Aqualift F / F XL* has powerful pumps in the versions S1 and/or S3 with a wide range of applications from an input power of 1.400 W to 5.500 W, a sensor control and a Comfort control unit with self-diagnosis system SDS.

Multiple inlet connections

The *Aqualift F / F XL* offers variable inlet connection sizes with diameters ranging from 110 to 160 mm and the option of adding further inlets with diameters from Ø 50 to Ø 200 mm on the pre-scored areas on the sides and back.

If you want to use the *Aqualift F / F XL* outside a building:

➤ Pumping station *Aquapump XL*: page 149

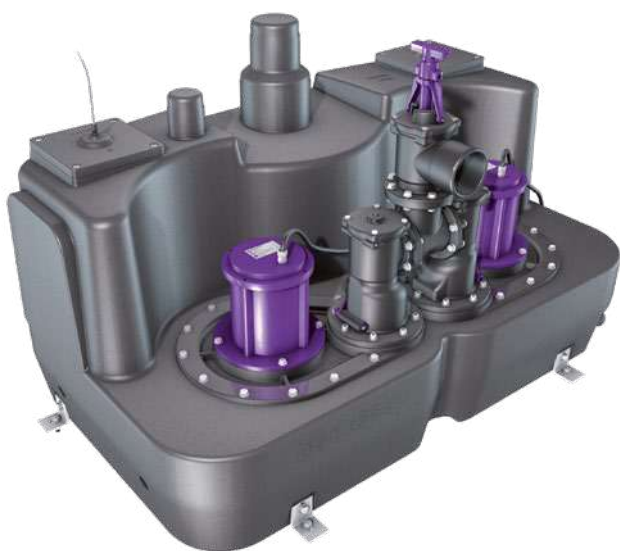
Maximum reliability

The intelligent control unit with integrated self-diagnosis system SDS and battery buffering continually monitors all electrical components and keeps an electronic operating log which can be read out.

**Modbus
on request**



Aqualift F
for domestic or light commercial use



Aqualift F XL
for commercial, industrial or communal use

Lifting station *Aqualift F XL Duo* 900 liter tank volume for free-standing installation in frost-free rooms



EN 12050-1

Tank volume: 900 liters

Pump volume: 500 liters

Polyethylene storage chamber

with air pressure level detector, clean-out opening. Spigots for vertical inlet \varnothing 110 mm / 160 mm, ventilation \varnothing 75 mm and for manual diaphragm pump \varnothing 32 mm. Horizontal inlet \varnothing 50 mm to \varnothing 200 mm by sawing.



Illustration shows Art. no. 11 054-9001

Duo version with two pumps

SPF pump	Voltage	Art. no.
Without closure valve		
3000-S3	400 V	11 054-9001
4500-S3	400 V	11 069-9001
5400-S3	400 V	11 082-9001

Pumps

Pressure sensor controlled twin wastewater SPF pumps with multi-vane impeller to pump wastewater with or without sewage (open channel passage 40 mm). Pump is rated submersible (IP 68), pump cable length 5 m. With sound-absorbing underlay mat (10 mm thick).

Vertical / horizontal outlet with integrated non-return valve, with/without closure valve (provided loose), with elastic hose section or flange.

Pressure outlet:

vertical \varnothing 110 without closure valve, horizontal \varnothing 110 with plastic closure valve or vertical DN 80 with cast iron closure valve

Comfort control unit

with mains power ON / OFF switch and multilingual digital display (EN, DE, FR, IT, PL, NL) showing current operational status, settings and logbook; control unit is splash proof (IP 54), wall mounted, voltage 400 V 50 Hz. With potential-free/BMS contact (optional 230 V).

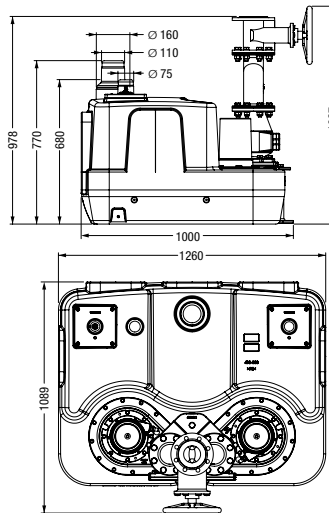
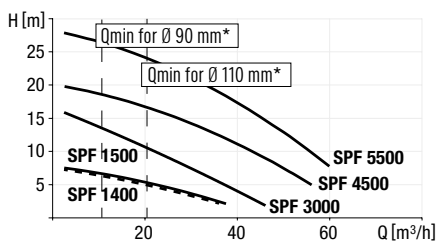


Illustration shows lifting station with closure valve

- **Accessories:** page 134 – 141
- **Note:** Also available in 60 Hz / 400 V page 108

Pumping capacity



Pump type	Input Power (P1)	Power (P2)	Voltage	Amperage	Weight	Pumping capacity	Pumping height
SPF 3000-S3-50%*	3.5 kW	2.8 kW	400 V	5.7 A	188 kg	47 m³/h	16 m
SPF 4500-S3-50%*	4.7 kW	3.7 kW	400 V	7.8 A	189 kg	55 m³/h	20 m
SPF 5500-S3-30%*	5.8 kW	4.9 kW	400 V	9.6 A	211 kg	60 m³/h	27 m

* Definition of S3-pump see page 101



Lifting station *Aqualift F XL Duo* 450 liter tank volume

for free-standing installation in frost-free rooms



EN 12050-1

Tank volume: 450 liters

Pump volume: 250 liters

Polyethylene storage chamber

with air pressure level detector, clean-out opening. Spigots for vertical inlet \varnothing 110 mm / 160 mm, ventilation \varnothing 75 mm and for manual diaphragm pump \varnothing 32 mm.

Horizontal inlet \varnothing 50 mm to \varnothing 200 mm by sawing.

Pumps

Pressure sensor controlled twin wastewater *SPF* pumps with multi-vane impeller to pump wastewater with or without sewage (open channel passage 40 mm). Pump is rated submersible (IP 68), pump cable length 5 m. With sound-absorbing underlay mat (10 mm thick).

Vertical / horizontal outlet with integrated non-return valve, with/without closure valve (provided loose), with elastic hose section or flange.

Pressure outlet:

vertical \varnothing 110 without closure valve, horizontal \varnothing 110 with plastic closure valve or vertical DN 80 with cast iron closure valve

Comfort control unit

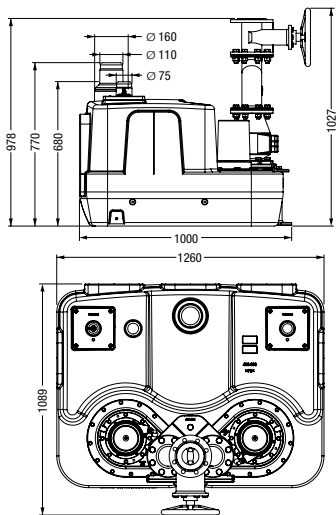
with mains power ON / OFF switch and multilingual digital display (EN, DE, FR, IT, PL, NL) showing current operational status, settings and logbook; control unit is splash proof (IP 54), wall mounted, voltage 230 V or 400 V at 50 Hz. With potential-free/BMS contact (optional 230 V).

➤ **Accessories:** page 134 – 141

➤ **Note:** Also available in 60 Hz / 400 V page 108



Illustration shows Duo version with cast iron closure valve



Duo version with two pumps

SPF pump	Voltage	Art. no.
Without closure valve		
3000-S3	400 V	11 054
3000-S1	400 V	11 115
4500-S3	400 V	11 069
4500-S1	400 V	11 126
5500-S3	400 V	11 082

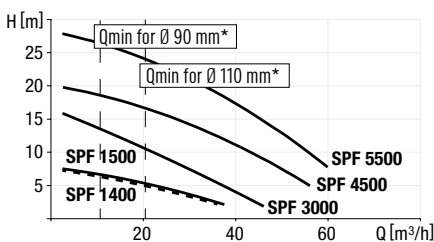
With plastic closure valve

3000-S3	400 V	11 055
3000-S1	400 V	11 116

With cast iron closure valve

3000-S3	400 V	11 057
3000-S1	400 V	11 118
4500-S3	400 V	11 070
4500-S1	400 V	11 127
5500-S3	400 V	11 083

Pumping capacity



Pump type	Input Power (P1)	Power (P2)	Voltage	Amperage	Weight	Pumping capacity	Pumping height
SPF 3000-S1/S3-100/50%*	3.2 kW	2.7 kW	400 V	5.4 A	188 kg	47 m ³ /h	16 m
SPF 4500-S1/S3-100/50%*	4.5 kW	3.7 kW	400 V	7.5 A	189 kg	55 m ³ /h	20 m
SPF 5500-S3-30%*	5.7 kW	4.7 kW	400 V	9.1 A	211 kg	60 m ³ /h	27 m

* Definition of S1 and S3-pumps see page 101



Lifting station *Aqualift F XL Mono / Duo* 300 liter tank volume

for free-standing installation in frost-free rooms



CE EN 12050-1

Tank volume: 300 liters

Pump volume: 175 liters

Polyethylene storage chamber

with clean-out opening. Spigots for vertical inlet \varnothing 110 mm/160 mm, ventilation \varnothing 75 mm and for manual diaphragm pump \varnothing 32 mm. Horizontal inlet \varnothing 50 mm to \varnothing 200 mm by sawing.

Pumps

Pressure sensor controlled twin wastewater *SPF* pumps with multi-vane impeller to pump wastewater with or without sewage (open channel passage 40 mm). Pump is rated submersible (IP 68), pump cable length 5 m. With sound-absorbing underlay mat (10 mm thick).

Vertical/ horizontal outlet with integrated non-return valve, with/without closure valve (provided loose), with elastic hose section or flange.

Pressure outlet:

vertical \varnothing 110 without closure valve, horizontal \varnothing 110 with plastic closure valve or vertical DN 80 with cast iron closure valve

Comfort control unit

with mains power ON / OFF switch and multi-lingual digital display (EN, DE, FR, IT, PL, NL) showing current operational status, settings and logbook; control unit is splash proof (IP 54), wall mounted, voltage 230 V or 400 V at 50 Hz. With potential-free/BMS contact (optional 230 V).

➤ **Accessories:** page 134 – 141

➤ **Note:** Also available in 60 Hz / 400 V page 108

Pumping capacity

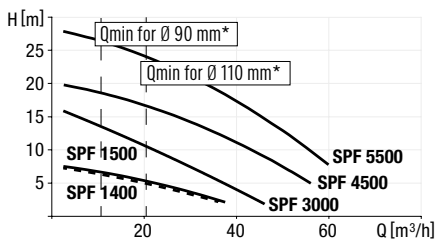


Illustration shows Duo version with plastic closure valve

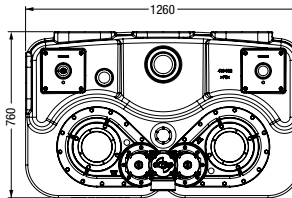
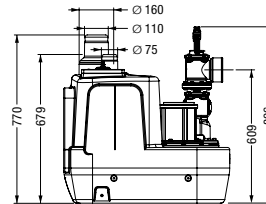
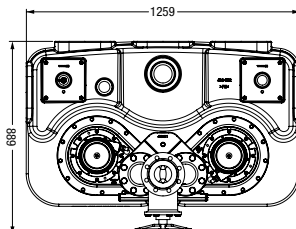
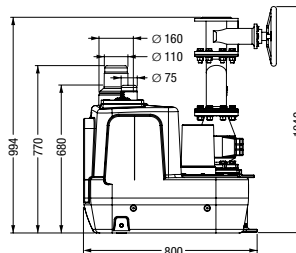


Illustration shows Duo version with cast iron closure valve



Mono version with one pump

SPF pump	Voltage	Art. no.
----------	---------	----------

Without closure valve

1400-S3	230 V	11 009
1500-S3	400 V	11 027
3000-S3	400 V	11 045
4500-S3	400 V	11 064
5500-S3	400 V	11 077

With plastic closure valve

1400-S3	230 V	11 011
1500-S3	400 V	11 029
3000-S3	400 V	11 047

With cast iron closure valve

1400-S3	230 V	11 015
1500-S3	400 V	11 033
3000-S3	400 V	11 051
4500-S3	400 V	11 066
5500-S3	400 V	11 079

Duo version with two pumps

SPF pump	Voltage	Art. no.
----------	---------	----------

Without closure valve

1400-S3	230 V	11 010
1400-S1	230 V	11 090
1500-S3	400 V	11 028
1500-S1	400 V	11 100
3000-S3	400 V	11 046
3000-S1	400 V	11 110
4500-S3	400 V	11 065
4500-S1	400 V	11 123
5500-S3	400 V	11 078

With plastic closure valve

1400-S3	230 V	11 012
1400-S1	230 V	11 091
1500-S3	400 V	11 030
1500-S1	400 V	11 101
3000-S3	400 V	11 048
3000-S1	400 V	11 111

With cast iron closure valve

1400-S3	230 V	11 016
1400-S1	230 V	11 092
1500-S3	400 V	11 034
1500-S1	400 V	11 103
3000-S3	400 V	11 052
3000-S1	400 V	11 113
4500-S3	400 V	11 067
4500-S1	400 V	11 124
5500-S3	400 V	11 080

Pump type	Input Power (P1)	Power (P2)	Voltage	Amperage	Weight	Pumping capacity	Pumping height
SPF 1400-S1-100%*	1.6 kW	1.1 kW	230 V	7.3 A	99 kg	38 m³/h	7 m
SPF 1500-S1-100%*	1.4 kW	1.1 kW	400 V	2.7 A	98 kg	40 m³/h	8 m
SPF 3000-S1-100%*	3.2 kW	2.7 kW	400 V	5.4 A	188 kg	47 m³/h	16 m
SPF 4500-S1-100%*	4.5 kW	3.7 kW	400 V	7.5 A	189 kg	55 m³/h	20 m
SPF 5500-S3-30%*	5.7 kW	4.7 kW	400 V	9.1 A	211 kg	60 m³/h	27 m

* Definition of S1 and S3-pumps see page 101

Lifting station *Aqualift F XL Mono / Duo* 200 liter tank volume



for free-standing installation in frost-free rooms

CE EN 12050-1

Tank volume: 200 liters

Pump volume: 120 liters

Polyethylene storage chamber

with clean-out opening. Spigots for vertical inlet \varnothing 110 mm/160 mm, ventilation \varnothing 75 mm and for manual diaphragm pump \varnothing 32 mm. Horizontal inlet \varnothing 50 mm to \varnothing 200 mm by sawing.

Pumps

Pressure sensor controlled single or twin wastewater *SPF* pumps with multi-vane impeller to pump wastewater with or without sewage (open channel passage 40 mm). Pump is rated submersible (IP 68), pump cable length 5 m. With sound-absorbing underlay mat (10 mm thick).

Vertical/ horizontal outlet with integrated non-return valve, with/without closure valve (provided loose), with elastic hose section or flange.

Pressure outlet:

vertical \varnothing 110 without closure valve, horizontal \varnothing 110 with plastic closure valve or vertical DN 80 with cast iron closure valve

Comfort control unit

with mains power ON / OFF switch and multilingual digital display (EN, DE, FR, IT, PL, NL) showing current operational status, settings and logbook; control unit is splash proof (IP 54), wall mounted, voltage 230 V or 400 V at 50 Hz. With potential-free/BMS contact (optional 230 V).

Accessories: page 134 – 141

Note: Also available in 60 Hz / 400 V page 108

Pumping capacity

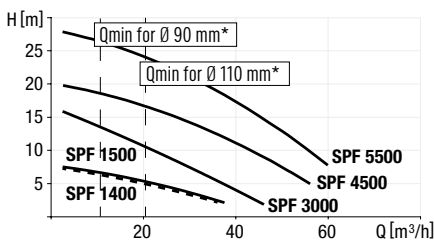


Illustration shows Duo version with plastic closure valve

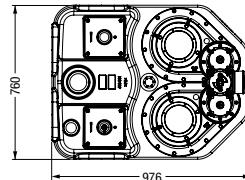
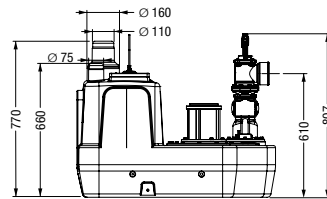
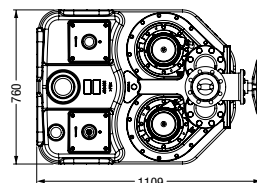
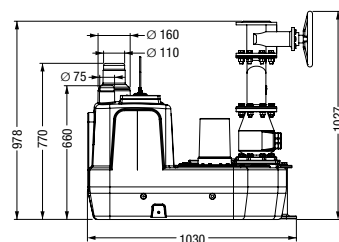


Illustration shows Duo version with cast iron closure valve



Mono version with one pump

SPF pump	Voltage	Art. no.
Without closure valve		
1400-S3	230 V	11 000
1500-S3	400 V	11 018
3000-S3	400 V	11 036
4500-S3	400 V	11 059
5500-S3	400 V	11 072

With plastic closure valve

1400-S3	230 V	11 002
1500-S3	400 V	11 020
3000-S3	400 V	11 038

With cast iron closure valve

1400-S3	230 V	11 006
1500-S3	400 V	11 024
3000-S3	400 V	11 042
4500-S3	400 V	11 061
5500-S3	400 V	11 074

Duo version with two pumps

SPF pump	Voltage	Art. no.
Without closure valve		
1400-S3	230 V	11 001
1400-S1	230 V	11 085
1500-S3	400 V	11 019
1500-S1	400 V	11 095
3000-S3	400 V	11 037
3000-S1	400 V	11 105
4500-S3	400 V	11 060
4500-S1	400 V	11 120
5500-S3	400 V	11 073

With plastic closure valve

1400-S3	230 V	11 003
1400-S1	230 V	11 086
1500-S3	400 V	11 021
1500-S1	400 V	11 096
3000-S3	400 V	11 039
3000-S1	400 V	11 106

With cast iron closure valve

1400-S3	230 V	11 007
1400-S1	400 V	11 088
1500-S3	230 V	11 025
1500-S1	400 V	11 098
3000-S3	400 V	11 043
3000-S1	400 V	11 108
4500-S3	400 V	11 062
4500-S1	400 V	11 121
5500-S3	400 V	11 075

Pump type	Input Power (P1)	Power (P2)	Voltage	Amperage	Weight	Pumping capacity	Pumping height
SPF 1400-S1/S3-100/50%*	1.6 kW	1.1 kW	230 V	7.3 A	99 kg	38 m ³ /h	7 m
SPF 1500-S1/S3-100/50%*	1.4 kW	1.1 kW	400 V	2.7 A	98 kg	40 m ³ /h	8 m
SPF 3000-S1/S3-100/50%*	3.2 kW	2.7 kW	400 V	5.4 A	188 kg	47 m ³ /h	16 m
SPF 4500-S1/S3-100/50%*	4.5 kW	3.7 kW	400 V	7.5 A	189 kg	55 m ³ /h	20 m
SPF 5500-S3-30%*	5.7 kW	4.7 kW	400 V	9.1 A	211 kg	60 m ³ /h	27 m

* Definition of S1 and S3-pumps see page 101

Lifting station *Aqualift F Duo* 120 liter tank volume for free-standing installation in frost-free rooms



CE EN 12050-1

Tank volume: 120 liters

Pump volume: 50 liters

Polyethylene storage chamber with clean-out opening. With sound-absorbing underlay mat (10 mm thick). Connection for inlet \varnothing 110 and ventilation \varnothing 75, connection coupling for manual diaphragm pump \varnothing 32 mm.

Pumps

SPF pumps for wastewater with or without sewage, pressure sensor controlled with multi-vane impeller. Open channel passage 40 mm. Pumps are rated submersible (IP 68), pump cable length 5 m. Outlet with integrated non-return valve, connection coupling \varnothing 110 with elastic hose section.

Pressure outlet:

vertical \varnothing 110 without closure valve or horizontal \varnothing 110 with closure valve

Comfort control unit

with mains power ON / OFF switch and multilingual digital display (EN, DE, FR, IT, PL, NL) showing current operational status, settings and logbook; control unit is splash proof (IP 54), wall mounted, voltage 230 / 400 V 50 Hz. With potential-free contact.

➤ **Accessories:** page 134 – 141

➤ **Note:** Also available in 60 Hz / 400 V page 108

* according to EN 12056-4

Pumping capacity

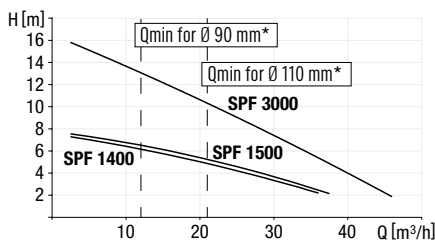


Illustration shows Art. no. 28 628-C

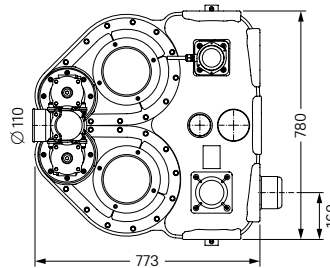
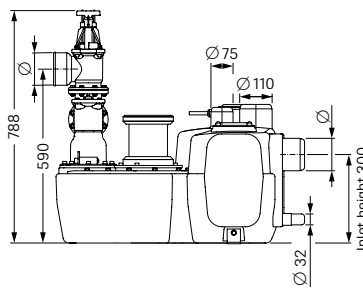


Illustration shows Art. no. 28 629-C

Duo version with two pumps

SPF pump	Voltage	Art. no.
Without closure valve		
1400-S3	230 V	28 628-C
1500-S3	400 V	28 764
3000-S3	400 V	28 765
1400-S1	230 V	11 605
1500-S1	400 V	11 604
3000-S1	400 V	11 606
With closure valve		
1400-S3	230 V	28 629-C
1500-S3	400 V	28 766
3000-S3	400 V	28 767
1400-S1	230 V	11 608
1500-S1	400 V	11 607
3000-S1	400 V	11 609

Pump type

	Input Power (P1)	Power (P2)	Voltage	Frequency	Amperage	Fuses surge-proof	Cable connections 5 m Length	Media temperature	Weight (Pump)	Protection	RPM	Pumping capacity	Pumping height
SPF 1400-S1/S3-100/50%*	1.6 kW	1.1 kW	230 V	50 Hz	7.3 A	16 A	3 × 1.0 mm ²	40°C	23 kg	IP 68	1.370	38 m ³ /h	7 m
SPF 1500-S1/S3-100/50%*	1.4 kW	1.1 kW	400 V	50 Hz	2.7 A	3 × 16 A	7 × 1.5 mm ²	40°C	24 kg	IP 68	1.415	40 m ³ /h	8 m
SPF 3000-S1/S3-100/50%*	3.2 kW	2.7 kW	400 V	50 Hz	5.4 A	3 × 16 A	7 × 1.5 mm ²	40°C	24 kg	IP 68	2.845	47 m ³ /h	16 m

* Definition of S1 and S3-pumps see page 101

Lifting station *Aqualift F Mono* 50 liter tank volume

for free-standing installation in frost-free rooms



CE EN 12050-1

Tank volume: 50 liters
Pump volume: 20 liters

Polyethylene storage chamber with clean-out opening. With sound-absorbing underlay mat (10 mm thick). Connection for inlet \varnothing 110 and ventilation \varnothing 75, connection coupling for manual diaphragm pump \varnothing 32 mm.

Pump

SPF pump for wastewater with or without sewage, pressure sensor controlled with multi-vane impeller. Open channel passage 40 mm. Pump is rated submersible (IP 68), pump cable length 5 m. Outlet with integrated non-return valve, connection coupling \varnothing 110 with elastic hose section.

Pressure outlet:

vertical \varnothing 110 without closure valve or horizontal \varnothing 110 with closure valve

Comfort control unit

with mains power ON / OFF switch and multilingual digital display (EN, DE, FR, IT, PL, NL) showing current operational status, settings and logbook; control unit is splash proof (IP 54), wall mounted, voltage 230 / 400 V 50 Hz. With potential-free contact.

- **Accessories:** page 134 – 141
- **Note:** Also available in 60 Hz / 400 V page 108



Illustration shows Art. no. 28 646-C

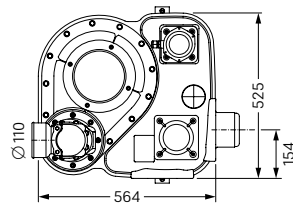
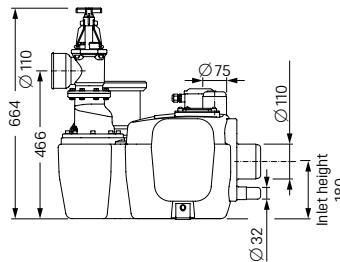


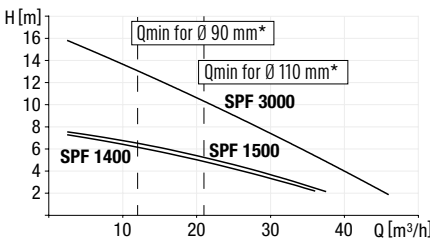
Illustration shows Art. no. 28 648-C

Mono version with one pump

SPF pump	Voltage	Art. no.
Without closure valve		
1400-S3	230 V	28 646-C
1500-S3	400 V	28 751
3000-S3	400 V	28 752
With closure valve		
1400-S3	230 V	28 648-C
1500-S3	400 V	28 753
3000-S3	400 V	28 754

* according to EN 12056-4

Pumping capacity



Pump type	Input Power (P1)	Power (P2)	Voltage	Frequency	Amperage	Fuses surge-proof	Cable connections 5 m Length	Media temperature	Weight (Pump)	Protection	RPM	Pumping capacity	Pumping height
SPF 1400-S3-50%*	1.6 kW	1.1 kW	230 V	50 Hz	7.3 A	16 A	3 × 1.0 mm ²	40°C	23 kg	IP 68	1.370	38 m ³ /h	7 m
SPF 1500-S3-50%*	1.4 kW	1.1 kW	400 V	50 Hz	2.7 A	3 × 16 A	7 × 1.5 mm ²	40°C	24 kg	IP 68	1.415	40 m ³ /h	8 m
SPF 3000-S3-50%*	3.2 kW	2.7 kW	400 V	50 Hz	5.4 A	3 × 16 A	7 × 1.5 mm ²	40°C	24 kg	IP 68	2.845	47 m ³ /h	16 m

* Definition of S3-pumps see page 101

Lifting station *Aqualift F Basic*

The economic version for domestic wastewater.

The economical alternative: for the disposal of domestic wastewater, we offer the lifting station *Aqualift F Basic* – cutting edge technology at an unbeatable price. It is suitable without any restrictions for the drainage of private toilets, showers and sinks in frost-protected rooms below the backwater level. The lifting station with integrated backflow preventer discharges the wastewater through the pressure pipe by means of a flood-proof pump.



1 Lifting station 2 Pressure pipe

Pump

The pump SPF 1300 with blockage-proof multi-vane vortex impeller pumps wastewater quantities of up to 32 m³ over a maximum height of 9.2 m. Thanks to the wedge-shaped tank base, wastewater and solids drain directly into the pump intake.

Control unit with float switch

The control unit *Aqualift F Basic* 230 V is used for continuous water level monitoring and fail-safe / precise pump operation. Switching and alarm levels are measured by a float switch.

Variable inlets

Ø 50 / 110 mm inlet connection from above, two additional 110 mm inlet connections on both sides. The pre-scored area on the back also enables further inlets with a diameter of up to 110 mm to be attached.

If you want to use the *Aqualift F Basic* outside the building:

➤ Pumping station *Aquapump Small*: page 163

Lifting station *Aqualift F Basic* for free-standing installation in frost-free rooms



EN 12050-1

Tank volume: 50 liters
Pump volume: 20 liters

Polyethylene storage chamber with screwed access opening. Inlet connection from above \varnothing 50/110 mm. Two additional \varnothing 110 mm inlet connections at both sides. With \varnothing 75 mm vent connection. Connection coupling for emergency diaphragm pump \varnothing 32 mm.

Pump

SPF 1300 pump for wastewater with or without sewage, float switch controlled (level and alarm) with multi-vane impeller. Open channel passage 40 mm. Pump is rated submersible. Pump cable length 5 m. Including back-water preventer, with plastic spigot pressure outlet \varnothing 90 mm including elastic hose connection.

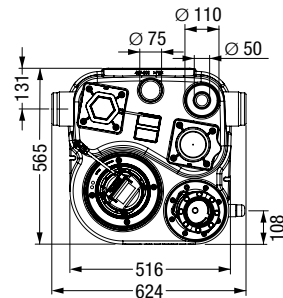
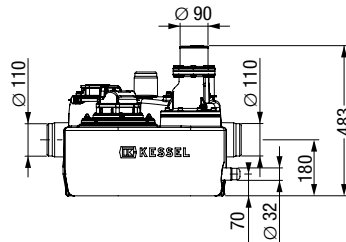
Control unit Basic 230 V

with function display, button for manual pump start and to reset alarm. Battery buffered alarms (battery included). With connection option for on-site potential free-contact.

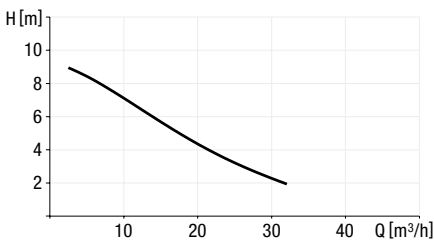
➤ **Accessories:** page 134 – 141



SPF pump	Voltage	Art. no.
1300-S3	230 V	28 798



Pumping capacity



Pump type	Input Power (P1)	Power (P2)	Voltage	Frequency	Amperage	Fuses	Cable connections 5 m Length	Media temperature	Weight (Pump)	Protection	RPM	Pumping capacity	Pumping height
SPF 1300-S3-15%*	1.5 kW	1.0 kW	230 V	50 Hz	6.7 A	C 10 A	3 × 1.5 mm ²	40°C	approx. 24 kg	IP 54	2.900	32 m ³ /h	9.2 m

* Definition of S3-pumps see page 101

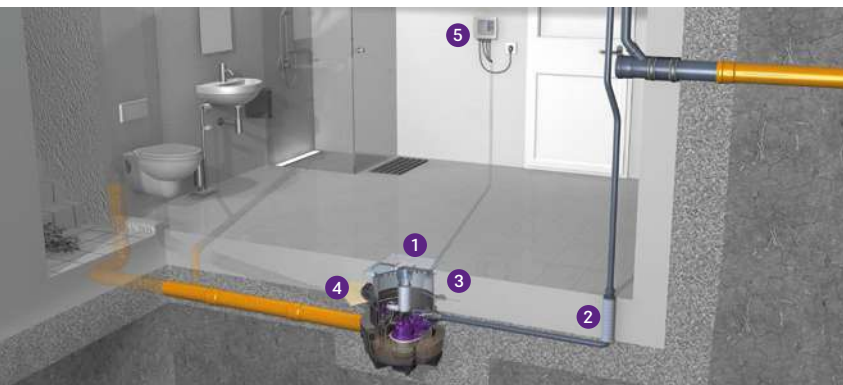


Lifting station *Aqualift F Compact*

The compact version for complete basement drainage.

One for all: the *Aqualift F Compact* takes over the complete basement drainage. The lifting station pumps the wastewater, even black water, into the sewer located above – even after a pipe burst or flooding – thanks to the floor drain integrated into the cover. The compact dimensions allow for the straightforward installation or free-standing set-up of the *Aqualift F Compact*. It is controlled by the Comfort control unit with self-diagnosis system SDS that is supplied ready for connection.

The *Aqualift F Compact* is available in two versions, either for freestanding set-up or for floor slab installation (available with black or recessed tileable cover). In addition, each device is available as a Mono or Duo lifting station.



1 Lifting station 2 Pressure pipe set 3 Extension section
4 Gasket set 5 Control unit

Floor slab installation

The *Aqualift F Compact* is almost invisible if it is installed in the floor slab. The integrated drain in the cover handles basement surface water even in the event of a pipe burst or flooding, the *Aqualift F Compact* continually pumps away the wastewater, keeping the basement dry.

Installation in waterproof concrete

The KESSEL sealing kit for installation in waterproof concrete ensures reliable protection against moisture damage. The extension section with central flange and elastomeric waterproofing membrane enable implementation also in deeper installation situations.

Maximum safety

The intelligent control unit with integrated self-diagnosis system SDS and battery buffering continually monitors all electrical components and keeps an electronic operating log which can be read out.



1 Lifting station 2 Control unit 3 Pressure pipe

Lifting station *Aqualift F Compact Mono / Duo*

for installation in a concrete slab / floor



Z-53.2-484 Max 2 WC connections

Tank volume: 40 liters
Pump volume: 20 liters

Polyethylene storage chamber for installation in a concrete slab / floor, with recessed cover for on-site tiling and drain, installation depth (D) 490 to 600 mm, with odour trap, sealing water height 50 mm, with lateral inlet \varnothing 110.

Installation area 800 × 800 mm.

Upper section and cover

With telescopic upper section for free height and level adjustment, recessed cover for on-site tiling, made of polymer class A 15, with moisture protective sealing flange.

Pump

Single or twin removable SPZ pump(s) with macerator, pressure sensor controlled, with integrated backwater flap.

Control unit

with SDS control unit (self-diagnosis system) for fully automatic pump control, splash water protected (IP 54), wall mounted. Pressure connection: 1 1/2 inch outer thread or pressure pipe \varnothing 40 mm for PVC glued connection or pressure pipe set (Art. no. 28 040).

Power cable length: 5 m

Note: A ventilation pipe must be provided for on site.

➤ **Accessories:** page 134 – 141



Illustration shows Mono version 28 701X

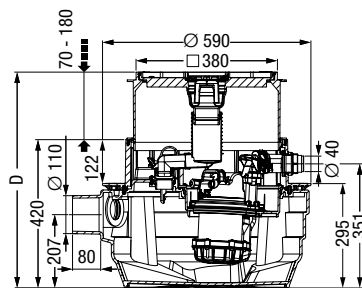
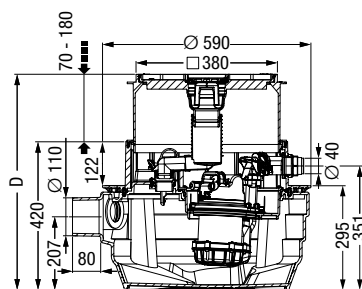
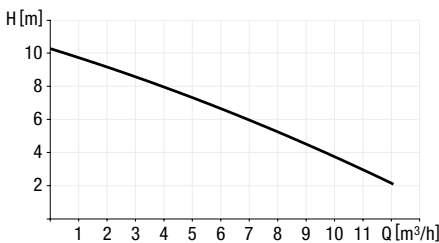


Illustration shows Duo version 28 704X



Pumping capacity



Pump type

Current type	Voltage	Current	Power P1/P2	RPM	Motor protection	Pumping height	Pumping capacity
SPZ 1000-S3-50%*	230 V	5.2 A	1.2 kW / 0.69 kW	2800 min ⁻¹	integrated	10 m	11.5 m³/h
SPZ 1000-S3-50% resistant*	230 V	5.2 A	1.2 kW / 0.69 kW	2800 min ⁻¹	integrated	10 m	11.5 m³/h

* Definition of S3-pumps see page 101

Mono version with one pump

SPZ pump	Voltage	Art. no.
With recessed cover for on-site tiling		
1000-S3	230 V	28 701X
1000-S3 resistant	230 V	28 701XC
With black cover		
1000-S3	230 V	28 701S
1000-S3 resistant	230 V	28 701SC

Duo version with two pumps

SPZ pump	Voltage	Art. no.
With recessed cover for on-site tiling		
1000-S3	230 V	28 704X
1000-S3 resistant	230 V	28 704XC
With black cover		
1000-S3	230 V	28 704S
1000-S3 resistant	230 V	28 704SC



Lifting station *Aqualift F Compact Mono / Duo* for free-standing installation



Z-53.2-484 Max 2 WC connections

Tank volume: 40 liters

Pump volume: 20 liters

Polyethylene storage chamber for free-standing installation, with lateral inlet \varnothing 110. Installation area 700 × 700 mm.

Pump

Single or twin removable SPZ pump(s) with macerator, pressure sensor controlled, with integrated backwater flap.

Control unit

with SDS control unit (self-diagnosis system) for fully automatic pump control, splash water protected (IP 54), wall mounted.

Pressure connection: 1 1/2 inch outer thread or pressure pipe \varnothing 40 mm for PVC glued connection or pressure pipe set (Art. no. 28 040).

Power cable length: 5 m

Note: A ventilation pipe must be provided for on site.

➤ **Accessories:** page 134 – 141



Illustration shows Mono version 28 717

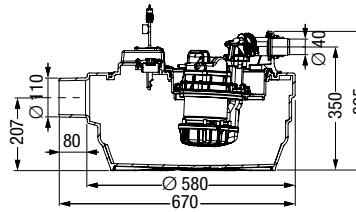
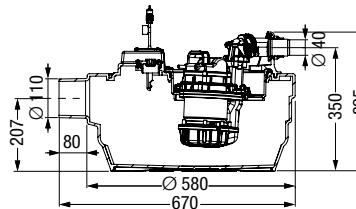


Illustration shows Duo version 28 718



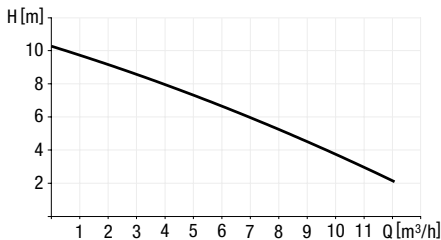
Mono version with one pump

SPZ pump	Voltage	Art. no.
1000-S3	230 V	28 717
1000-S3 resistant	230 V	28 717C

Duo version with two pumps

SPZ pump	Voltage	Art. no.
1000-S3	230 V	28 718
1000-S3 resistant	230 V	28 718C

Pumping capacity



Pump type

Pump type	Current type	Voltage	Current	Power P1/P2	RPM	Motor protection	Pumping height	Pumping capacity
SPZ 1000-S3-50%*	Alternating current	230 V	5.2 A	1.2 kW / 0.69 kW	2800 min ⁻¹	integrated	10 m	11.5 m³/h
SPZ 1000-S3-50% resistant*	Alternating current	230 V	5.2 A	1.2 kW / 0.69 kW	2800 min ⁻¹	integrated	10 m	11.5 m³/h

* Definition of S3-pumps see page 101



Lifting station *Minilift F*

The small version with the powerful macerator SharkTwister.

Compact and also suitable for black water: the *Minilift F* for free-standing set-up drains the toilet and other sanitary units in rooms below the backwater level or without sufficient slope to the next wastewater collecting pipe. The small lifting station chops faeces and toilet paper reliably with the powerful high-quality macerator SharkTwister.

Powerful macerator SharkTwister

The built-in stainless steel pump with the powerful high-quality macerator reliably chops faeces and toilet paper – thus providing maximum operational safety.

Intelligent control technology

The SharkTwister is controlled by intelligent control technology with an acoustic alarm function – without the need for a separate control unit.

Straightforward maintenance

The pump is integrated ready to plug in without the help of an electrician and can be removed for maintenance in no time at all.

Compact lifting station *Minilift F* for free-standing installation in frost protected rooms



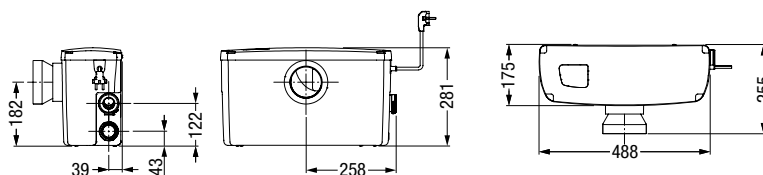
EN 12050-3

Plug-and-play sewage lifting station with macerator for wastewater disposal from a single toilet.

For free-standing set-up.

With pneumatic level control, with activated carbon filter, interior electronics separate from wastewater tank - easy, odour free maintenance

Power cable length: 1.6 m

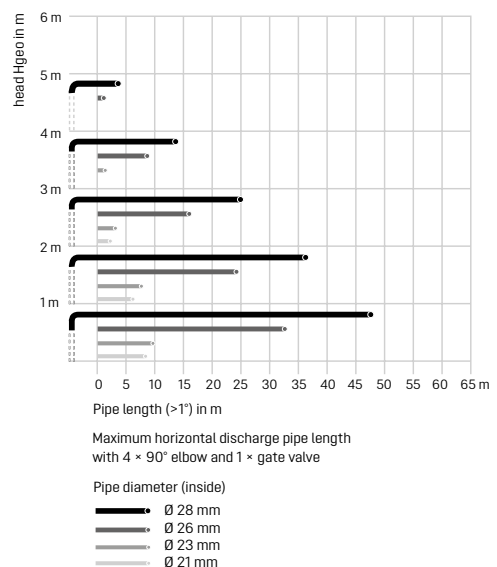


Voltage

Art. no.

230 V

28 520



Lifting station *Aqualift S 100 / S 200*

The flexible option for free-standing set-up.

Flexible and powerful: The *Aqualift S 100 / S 200* lifting station is the perfect choice for renovation or other installation situations that require free-standing set-up. Due to its small installation area, it can also be easily integrated in small rooms by retrofitting. And thanks to the one-handed closure that can be operated without tools, maintenance is quick and easy.



1 Lifting station 2 Grease separator 3 Pressure pipe

Wastewater tank

Tanks with 100 and 200 l capacity are available to choose from. Both tanks fit through standard size doors with 80 cm wide passage. They can therefore be retrofitted into most rooms without any issue.

Pumps

The *Aqualift S 100 / S 200* is equipped with one or two pumps. There are two models to choose from: a 650 watt pump with S1 mode (continuous operation) with float switch or control unit and a 1.3 kilowatt pump with S3 mode (non-continuous operation) with control unit. Both pump types handle wastewater without sewage by means of a multi-vane impeller.

Ideal for connecting to grease separators

The *Aqualift S 100 / S 200 Duo* with two pumps is ideally suited for drainage systems which cannot afford to go off-line – for example directly after a grease separator.

The large easy-access maintenance cover, which can be opened in seconds using the tool free one-handed closure, also contributes to the system's ease of use. An additional advantage is the norm approved integrated sampling chamber located inside the *Aqualift S*. With the new *Aqualift S 100 / S 200*, an extra sampling chambers is no longer required.

Lifting station *Aqualift S 200 Duo Tronic* for free-standing installation and wastewater without sewage



EN 12050-2

Lifting station for wastewater without sewage, free-standing set-up, preassembled for final installation on site.

- With odour-tight cover and quick-release closure for easy maintenance
- Tank made of PE, resistant to aggressive wastewater
- Including backflow preventer for the pressure pipe
- Including socket Ø 110 and Ø 160 mm for inlet and sampling
- Pumps with multi-vane impeller for maximum operating reliability

Version:

Type of system: Twin station / Pump control: Control unit / Backflow preventer: integrated / Installation situation: free-standing set-up / Type of wastewater: wastewater without sewage

General characteristics:

Colour: black / Standard: EN 12050-2

Dimensions:

Length: 670 mm / Width: 655 mm / Height: 815 mm

Tank:

Inlet nominal size (Ø): 110 – 160 mm / Tank volume: 220 l

Pressure pipe connection (Ø): 63 mm

Pumping volume: 100 l

Coverage features:

Cover material: Polymer / Colour of cover: violet / Tightness: odour-tight / Locking: Quick-release closure

Free passage: 30 mm

Pump:

Type of fuse required (electrical protection): C 16 A /

Max. temperature (permanent) of conveyed material: 40 °C / Connection type: coded plug /

Length of mains cable for pump: 5 m /

Protection class (pump): IP 68 (3 m) /

Type of pump connection cable: H07RN-F 3G 1.0 mm²

Comfort control unit:

Including: Self-diagnosis system (SDS), battery buffering, multi-line digital display, log book function, USB interface, GSM interface / Potential-free contact: optional / Protection class control unit: IP 54 / Length of mains cable for control unit: 1.4 m / Type of level measurement: pneumatic / Alarm sensor: Immersion pipe

Note: Pumps available as resistant versions on request: individual@kessel.de

➤ **Accessories:** page 134 – 141



Illustration shows Art. no. 28 518

Duo version with two pumps

GTF pump	Voltage	Art. no.
600-S1	230 V	28 517
1250-S1	230 V	28 518

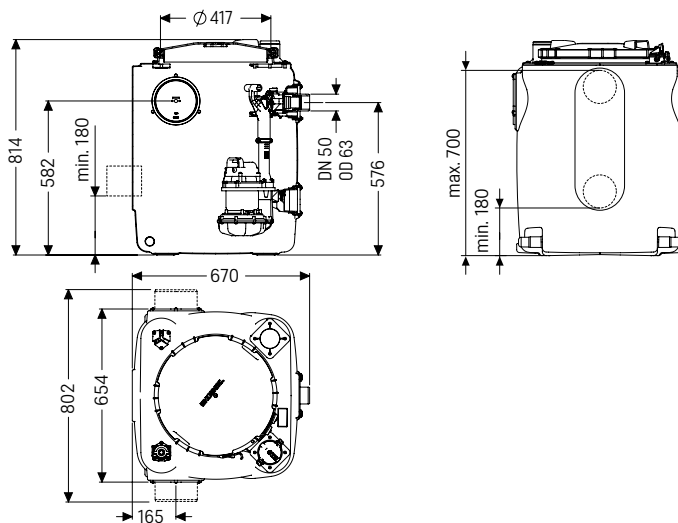
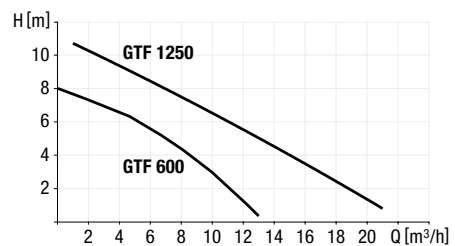


Illustration shows.: Art. no. 28 518

Pumping capacity



Pump type	Voltage	Current	Power (P1/P2)	RPM	Pumping height	Pumping capacity
GTF 600-S1*	230 V ~ 50 Hz	2.9 A	0.65 kW / 0.4 kW	2750 min ⁻¹	8 m	12 m ³ /h
GTF 1250-S1*	230 V ~ 50 Hz	5.4 A	1.3 kW / 0.8 kW	2700 min ⁻¹	11 m	20 m ³ /h

* Definition of S1-pump see page 101

Lifting station *Aqualift S 100 Mono / Duo Tronic*

for free-standing installation and wastewater without sewage



EN 12050-2

Lifting station for wastewater without sewage, free-standing set-up, preassembled for final installation on site.

- With odour-tight cover and quick-release closure for easy maintenance
- Tank made of PE, resistant to aggressive wastewater
- Including backflow preventer for the pressure pipe
- Including socket Ø 110 and Ø 160 mm for inlet and sampling
- Pump/s with multi-vane impeller for maximum operating reliability

Version:

Type of system: Single or twin station / Pump control: Control unit / Backflow preventer: integrated / Installation situation: free-standing set-up / Type of wastewater: wastewater without sewage

General characteristics:

Colour: black / Standard: EN 12050-2

Dimensions:

Length: 670 mm / Width: 530 mm / Height: 650 mm

Tank:

Inlet nominal size (Ø): 110 – 160 mm / Tank volume: 120 l

Pressure pipe connection (Ø): 63 mm

Pumping volume: 50 l

Coverage features:

Cover material: Polymer / Colour of cover: violet /

Tightness: odour-tight / Locking: Quick-release closure

Free passage: 10 mm

Pump:

Type of fuse required (electrical protection): C 16 A /

Max. temperature (permanent) of conveyed material: 40 °C / Connection type: coded plug /

Length of mains cable for pump: 5 m /

Protection class (pump): IP 68 (3 m) /

Type of pump connection cable: H07RN-F 3G 1.0 mm²

Comfort control unit:

Including: Self-diagnosis system (SDS), battery buffering, multi-line digital display, log book function, USB interface, GSM interface / Potential-free contact: optional / Protection class control unit: IP 54 /

Length of mains cable for control unit: 1.4 m /

Type of level measurement: pneumatic / Alarm sensor: Immersion pipe

Note: Pumps available as resistant versions

on request: individual@kessel.de

Accessories: page 134 – 141



Illustration shows Art. no. 28 515

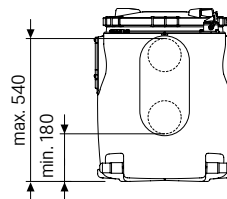
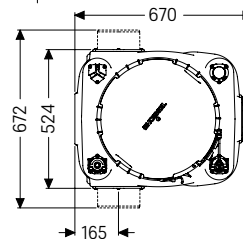
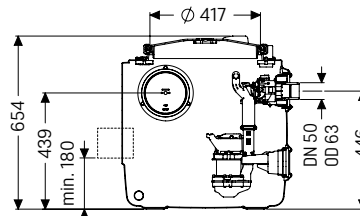


Illustration shows: Art. no. 28 513

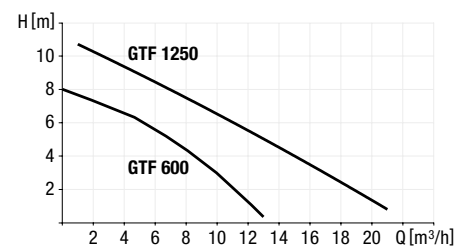
Mono version with one pump

GTF pump	Voltage	Art. no.
600-S1	230 V	28 513
1250-S1	230 V	28 514

Duo version with two pumps

GTF pump	Voltage	Art. no.
600-S1	230 V	28 515
1250-S1	230 V	28 516

Pumping capacity



Pump type

Pump type	Voltage	Current	Power (P1/P2)	RPM	Pumping height	Pumping capacity
GTF 600-S1*	230 V ~ 50 Hz	2.9 A	0.65 kW / 0.4 kW	2750 min ⁻¹	8 m	12 m ³ /h
GTF 1250-S1*	230 V ~ 50 Hz	5.4 A	1.3 kW / 0.8 kW	2700 min ⁻¹	11 m	20 m ³ /h

* Definition of S1-pump see page 101

Lifting station *Aqualift S 100 Mono*

for free-standing installation and wastewater without sewage



EN 12050-2

Lifting station for wastewater without sewage, free-standing set-up, preassembled for final installation on site.

- With odour-tight cover and quick-release closure for easy maintenance
- Tank made of PE, resistant to aggressive wastewater
- Including backflow preventer for the pressure pipe
- Including socket Ø 110 and Ø 160 mm for inlet and sampling
- Pump/s with multi-vane impeller for maximum operating reliability

Version:

Type of system: Single station / Pump control: Float switch / Backflow preventer: integrated / Installation situation: free-standing set-up / Type of wastewater: wastewater without sewage

General characteristics:

Colour: black / Standard: EN 12050-2

Dimensions:

Length: 670 mm / Width: 530 mm / Height: 650 mm

Tank:

Inlet nominal size (Ø): 110 – 160 mm / Tank volume: 120 l

Pressure pipe connection (Ø): 63 mm

Pumping volume: 25 l

Coverage features:

Cover material: Polymer / Colour of cover: violet /

Tightness: odour-tight / Locking: Quick-release closure

Free passage: 10 mm

Pump:

Type of fuse required (electrical protection): C 16 A /

Max. temperature (permanent) of conveyed material:

40 °C / Connection type: Schuko (earthed contact)

2-pin / Length of mains cable for pump: 5 m /

Protection class (pump): IP 68 (3 m) /

Type of pump connection cable: H07RN-F 3G 1.0 mm²

Note: Pumps available as resistant versions on request: individual@kessel.de

➤ **Accessories:** page 134 – 141



Illustration shows Art. no. 28 511

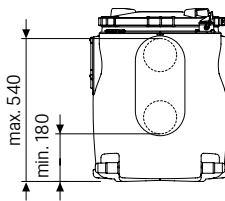
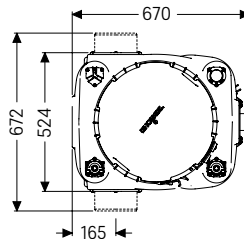
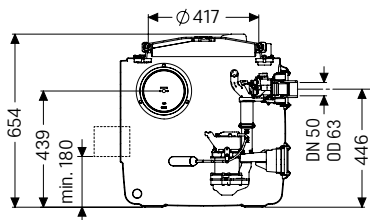
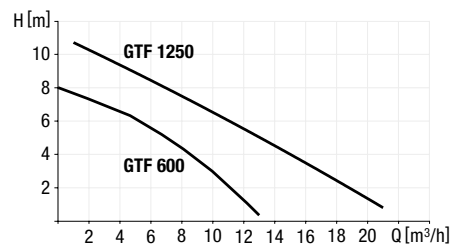


Illustration shows: Art. no. 28 511

Mono version with one pump

GTF pump	Voltage	Art. no.
600-S1	230 V	28 511
1250-S1	230 V	28 512

Pumping capacity



Pump type	Voltage	Current	Power (P1/P2)	RPM	Pumping height	Pumping capacity
GTF 600-S1*	230 V ~ 50 Hz	2.9 A	0.65 kW / 0.4 kW	2750 min ⁻¹	8 m	12 m ³ /h
GTF 1250-S1*	230 V ~ 50 Hz	5.4 A	1.3 kW / 0.8 kW	2700 min ⁻¹	11 m	20 m ³ /h

* Definition of S1-pump see page 101



Lifting station *Aqualift S Compact*

The flexible version
for wastewater without sewage.

The *Aqualift S Compact* is the first lifting station in our range that can be converted comfortably from a Mono to a Duo system after floor slab installation. Yet that is not the only feature that makes the *Aqualift S Compact* so special: the free suspension and acoustic decoupling of the pump(s) also makes particularly quiet operation possible.

The *Aqualift S Compact* is available with float switch or pneumatic level measurement. The lifting station can also take up and discharge water additionally from the surface through the drain integrated in the black or tileable cover. It is delivered from the factory with either one or two pumps; the new GTF 500 and GTF 500 resistant (for aggressive wastewater such as heating condensate).



1 Lifting station 2 Extension section with flange 3 Cover with integrated inlet

Maximum safety

The *Aqualift S Compact* is available with a pressure sensor *Tronic*, which measures the level of the wastewater precisely and reliably: as soon as the maximum water level is reached, the pump activates and pumps the water through a pressure pipe into the sewer.

Floor slab installation

The lifting station is almost invisible because it is installed in the floor slab. The integrated drain in the cover handles basement surface water. Even in the event of a pipe burst or flooding, the *Aqualift S Compact* continually pumps away the wastewater keeping the basement dry.

Installation in waterproof concrete

The KESSEL sealing kit for installation in waterproof concrete ensures reliable protection against moisture damage. The extension section with central flange and elastomeric waterproofing membrane enable implementation also in deeper installation situations.

Lifting station *Aqualift S Compact Mono / Duo Tronic*

for installation in a concrete slab / floor



CE EN 12050-2

Tank volume: 65 liters
Pump volume: 20 liters

Polyethylene storage chamber

for installation in a concrete slab / floor,
 installation depth (D) 490 to 620 mm,
 with lateral inlet \varnothing 110 mm.
 Installation area 700 × 700 mm.

Upper section and cover

Vertically and laterally adjustable upper section,
 with black / recessed cover for on-site tiling,
 integrated drain, made of polymer, load class K 3,
 with moisture protective sealing flange.

Pump

Single or twin removable *GTF* pump(s) for
 wastewater without sewage, float switch /
 air pressure sensor controlled with multi-vane
 impeller, with integrated non-return flap,
 pumping volume 20 liters (*GTF 500* / *GTF 1200*),
 pressure pipe connection \varnothing 40 mm.

Control unit

Tronic versions with SDS control unit (self-diagnosis
 system) for fully automatic pump control, splash
 water protected (IP 54), wall mounted.

Power cable length: 5 m

Note: A ventilation pipe must be provided for on site.

Accessories: page 134 – 141



Illustration shows Art. no. 280 550X

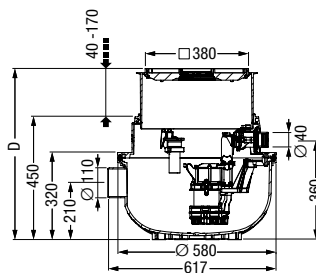
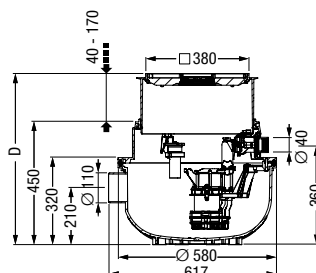


Illustration shows Art. no. 280 550XC



Mono version with one pump

GTF pump	Voltage	Art. no.
With recessed cover for on-site tiling		
500-S1	230 V	280 550X
500-S1 resistant	230 V	280 550XC
1200-S1	230 V	281 250X
1200-S1 resistant	230 V	281 250XC

With black cover

500-S1	230 V	280 550S
500-S1 resistant	230 V	280 550SC
1200-S1	230 V	281 250S
1200-S1 resistant	230 V	281 250SC

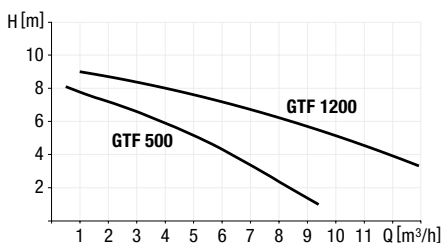
Duo version with two pumps

GTF pump	Voltage	Art. no.
With recessed cover for on-site tiling		
500-S1	230 V	280 530X
500-S1 resistant	230 V	280 530XC
1200-S1	230 V	281 230X
1200-S1 resistant	230 V	281 230XC

With black cover

500-S1	230 V	280 530S
500-S1 resistant	230 V	280 530SC
1200-S1	230 V	281 230S
1200-S1 resistant	230 V	281 230SC

Pumping capacity



Pump type	Voltage	Amperage	Power P1/P2	RPM	Pumping height	Pumping capacity
GTF 500-S1*	230 V ~ 50 Hz	2.7 A	0.6 kW / 0.36 kW	2800 min ⁻¹	8 m	10 m³/h
GTF 500-S1 resistant*	230 V ~ 50 Hz	2.7 A	0.6 kW / 0.36 kW	2800 min ⁻¹	8 m	10 m³/h
GTF 1200-S1*	230 V ~ 50 Hz	6.2 A	1.4 kW / 0.84 kW	2650 min ⁻¹	9 m	15.5 m³/h
GTF 1200-S1 resistant*	230 V ~ 50 Hz	6.2 A	1.4 kW / 0.84 kW	2650 min ⁻¹	9 m	15.5 m³/h

* Definition of S1-pump see page 101



Always the right choice:
kessel.com/smartselect

Lifting stations

3.1

Lifting station *Aqualift S Compact Mono*

for installation in a concrete slab / floor



CE EN 12050-2

Tank volume: 65 liters

Pump volume: 16 liters

Polyethylene storage chamber

for installation in a concrete slab/floor, installation depth (D) 490 to 620 mm, with lateral inlet \varnothing 110 mm. Installation area 700 × 700 mm.

Upper section and cover

Vertically and laterally adjustable upper section, with black / recessed cover for on-site tiling, integrated drain, made of polymer, load class K 3, with moisture protective sealing flange.

Pump

Single removable *GTF* pump for wastewater without sewage, float switch / air pressure sensor controlled with multi-vane impeller, with integrated non-return flap, pumping volume 16 liters (*GTF 500* / *GTF 1200*), pressure pipe connection \varnothing 40 mm.

Control unit

Tronic versions with SDS control unit (self-diagnosis system) for fully automatic pump control, splash water protected (IP 54), wall mounted.

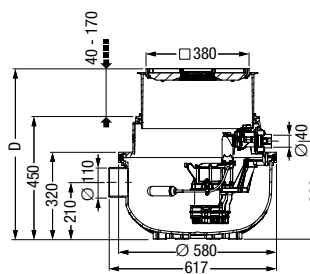
Power cable length: 5 m

Note: A ventilation pipe must be provided for on site.

Accessories: page 134 – 141

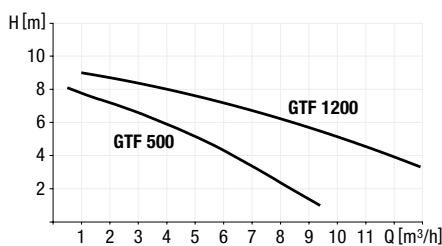


Illustration shows Art. no. 280 500X



GTF pump	Voltage	Art. no.
With recessed cover for on-site tiling		
500-S1	230 V	280 500X
500-S1 resistant	230 V	280 500XC
1200-S3	230 V	281 200X
1200-S3 resistant	230 V	281 200XC
With black cover		
500-S1	230 V	280 500S
500-S1 resistant	230 V	280 500SC
1200-S3	230 V	281 200S
1200-S3 resistant	230 V	281 200SC

Pumping capacity



Pump type	Voltage	Amperage	Power P1/P2	RPM	Pumping height	Pumping capacity
GTF 500-S1*	230 V ~ 50 Hz	2.7 A	0.6 kW / 0.36 kW	2800 min ⁻¹	8 m	10 m ³ /h
GTF 500-S1 resistant*	230 V ~ 50 Hz	2.7 A	0.6 kW / 0.36 kW	2800 min ⁻¹	8 m	10 m ³ /h
GTF 1200-S3*	230 V ~ 50 Hz	6.2 A	1.4 kW / 0.84 kW	2650 min ⁻¹	9 m	15.5 m ³ /h
GTF 1200-S3 resistant*	230 V ~ 50 Hz	6.2 A	1.4 kW / 0.84 kW	2650 min ⁻¹	9 m	15.5 m ³ /h

* Definition of S1 and S3-pumps see page 101



Lifting station *Minilift S*



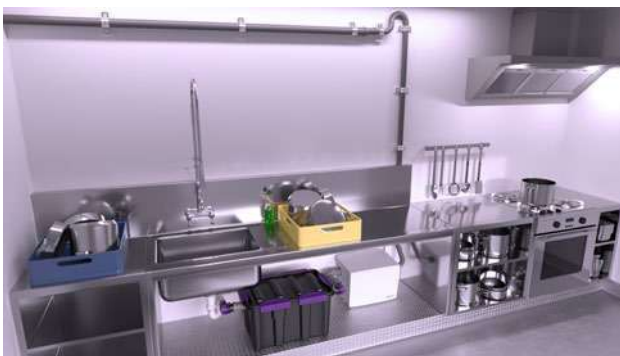
The *Minilift S* for wastewater without sewage makes everything possible.

Small in size but great possibilities: The plug-in ready *Minilift S* lifting station for restricted use is suitable for the disposal of wastewater from individual drainage objects, such as a wash basin, dishwasher or shower.

Adjustable
pumping volume

3 pump capacities

Resistance to hot
water and brine



Together with the grease separator UnderSink the Minilift S creates a perfect team for small kitchens.

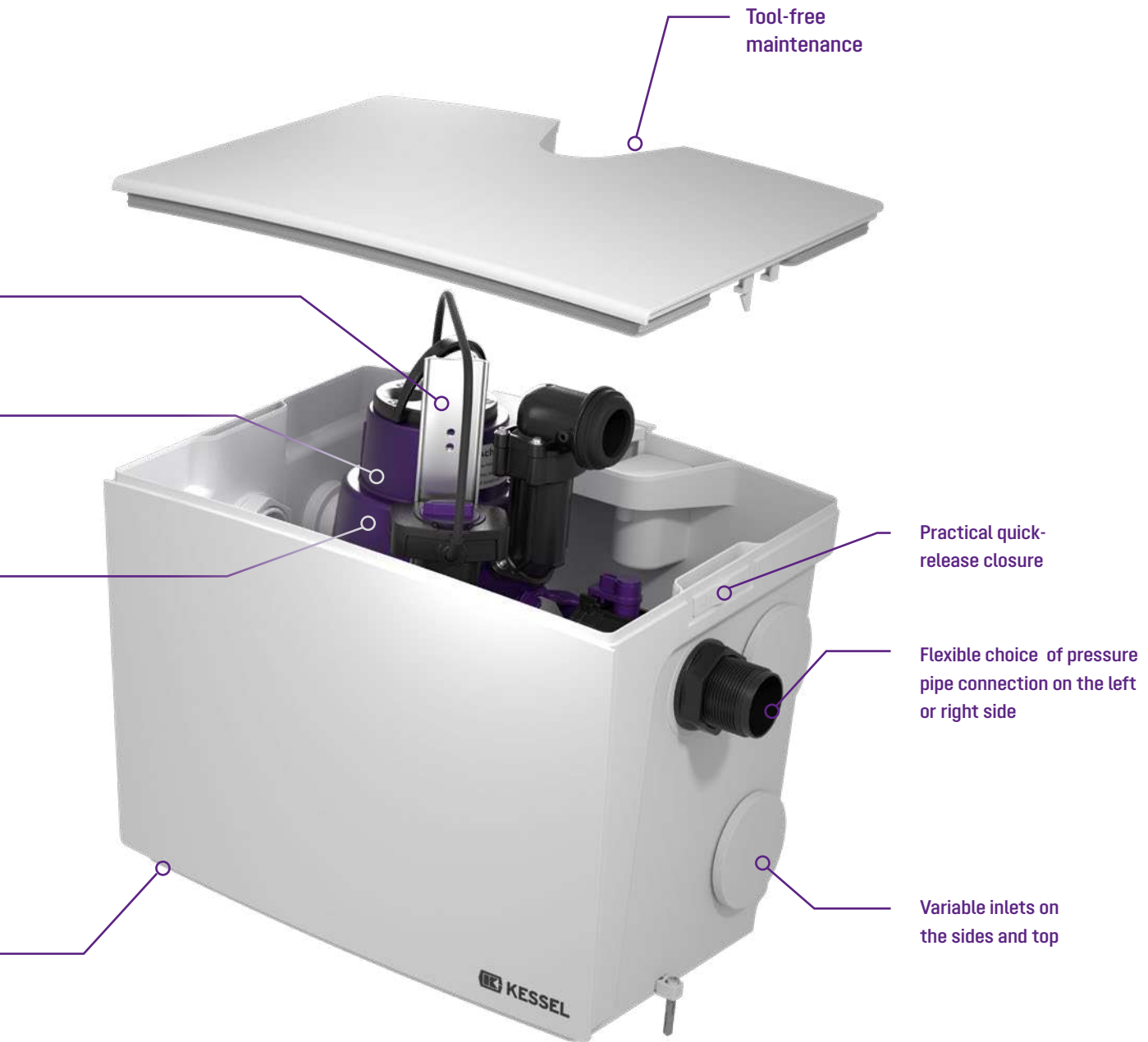
Feet for sound decoupling
and slip protection



A clean matter: The *Minilift S* is a practical solution for washing machines and wash basin in laundry rooms.



The *Minilift S* plays out its functional strengths in utility rooms. A water softener, backwash filter or heating system can be connected without any problems.



The *Minilift S* is ideal for renovations in small bathrooms next to a hobby room or in a workshop.



A talented solution for the office: The *Minilift S* can easily find a place in small office kitchens.

Minilift S lifting station for free-standing installation

The plug-in ready *Minilift S* lifting station for restricted use is suitable for the disposal of domestic wastewater and ideal for connecting a shower, bathtub, washbasin, sink, dishwasher or washing machine.

Type of wastewater: wastewater without sewage

Installation situation: free-standing set-up

Version:

Type of system: single station

Pump control: float switch

Backflow preventer: integrated

Resistant:

- Resistant to saline media,
- Wastewater from softening units and
- Wastewater containing condensate from heating systems

Pressure pipe connection options:

1 1/2" thread, PVC adhesive connection, click adapter

Ventilation: activated carbon filter

Cable length: 5 m

Condition as supplied: plug-in ready

➤ **Accessories:** page 134 – 141

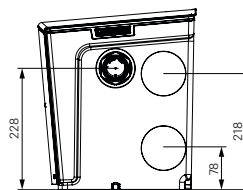
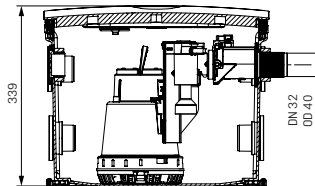
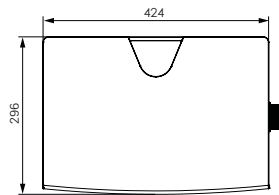
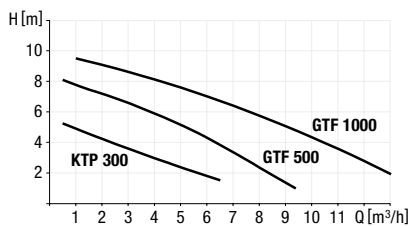


Fig.: Article 28561

Pump	Voltage	Art. no.
Submersible pump KTP 300		
KTP 300	230 V	28 561
KTP 300 resistant	230 V	28 561C
Submersible pump GTF 500		
GTF 500	230 V	28 562
GTF 500 resistant	230 V	28 562C
Submersible pump GTF 1000		
GTF 1000	230 V	28 563
GTF 1000 resistant	230 V	28 563C

Pumping capacity



Pump type	Power P1/P2	Power supply	Current	RMP	Plug	Cable length	Pumping height	Pumping capacity
KTP 300	0.34 kW / 0.21 kW	230 V ~ 50 Hz	1.6 A	2800 min	Schuko earthed safety plug	5 m	6 m	max. 8 m³/h
KTP 300 Resistant	0.34 kW / 0.21 kW	230 V ~ 50 Hz	1.6 A	2800 min	Schuko earthed safety plug	5 m	6 m	max. 8 m³/h
GTF 500	0.6 kW / 0.36 kW	230 V ~ 50 Hz	1.6 A	2800 min	Schuko earthed safety plug	5 m	8 m	max. 10 m³/h
GTF 500 Resistant	0.6 kW / 0.36 kW	230 V ~ 50 Hz	1.6 A	2800 min	Schuko earthed safety plug	5 m	8 m	max. 10 m³/h
GTF 1000	1.27 kW / 0.73 kW	230 V ~ 50 Hz	1.6 A	2800 min	Schuko earthed safety plug	5 m	10 m	max. 14.5 m³/h
GTF 1000 Resistant	1.27 kW / 0.73 kW	230 V ~ 50 Hz	1.6 A	2800 min	Schuko earthed safety plug	5 m	10 m	max. 14.5 m³/h



Lifting station *Minilift S*

For installation in a concrete floor / slab



CE EN 12050-2

Tank volume: 26 liters

Pump volume: 7 liters

Polyethylene storage chamber for installation in a concrete slab/floor, installation depth (D) 330 to 460 mm, with lateral inlet \varnothing 50 mm. Installation area 600 × 600 mm.

Upper section and cover

Vertically and laterally adjustable upper section, with black / recessed cover for on-site tiling, integrated drain, made of polymer, load class K 3, with moisture protective sealing flange.

Pump

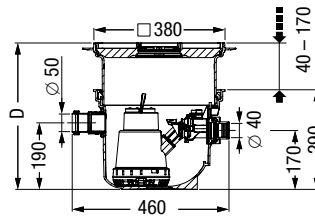
Single removable *KTP* pump for wastewater without sewage, float switch, with multi-vane impeller, with integrated non-return flap, pressure pipe connection 40 mm.



Illustration shows Art. no. 280 570X

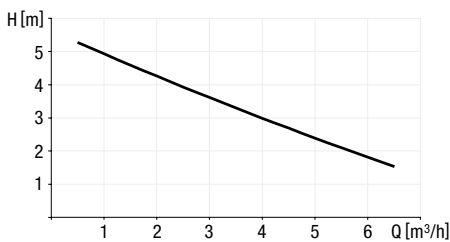


Illustration shows Art. no. 280 570S



KTP pump	Voltage	Art. no.
With recessed cover for on-site tiling		
300-S1	230 V	280 570X
300-S1 resistant	230 V	280 570XC
With black cover		
300-S1	230 V	280 570S
300-S1 resistant	230 V	280 570SC

Pumping capacity




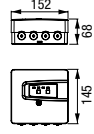
Pump type	Power P1 / P2	Voltage	Amperage	RPM	Plug	Cable length	Pumping height	Pumping capacity
KTP 300-S1*	0.34 kW / 0.21 kW	230 V ~ 50 Hz	1.6 A	2800 min ⁻¹	Schuko	5 m	6 m	8 m ³ /h
KTP 300-S1 resistant*	0.34 kW / 0.21 kW	230 V ~ 50 Hz	1.6 A	2800 min ⁻¹	Schuko	5 m	6 m	8 m ³ /h

* Definition of S1-pumps see page 101


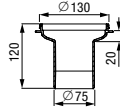

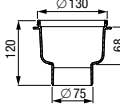

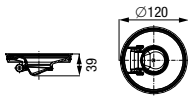

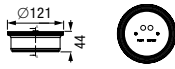



Accessories

Alarm unit

				Art. no.
with electrode probe	Compatibility: For lifting station <i>Aqualift F Basic</i> , <i>Aqualift F Compact</i> , <i>Aqualift S Compact</i> and <i>Minilift S</i> (280 570X, 280 570S, 280 570XC and 280 570SC) Function: High water / flood alarm system; for conductive liquids Cable length: 5 m (extendable up to 30 m)			20 222
with optical probe	Compatibility: For lifting station <i>Aqualift F Basic</i> , <i>Aqualift F Compact</i> , <i>Aqualift S Compact</i> and <i>Minilift S</i> (280 570X, 280 570S, 280 570XC and 280 570SC) Function: High water / flood alarm system; for conductive / non-conductive liquids Cable length: 5 m (extendable up to 30 m)			20 223
Potential-free contact	Compatibility: For warning devices Art. no. 20 222 and 20 223			20 224



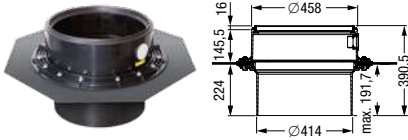
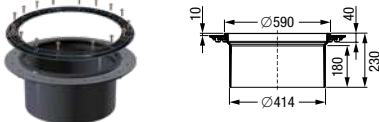
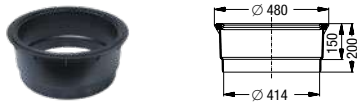


Hygiene and odour stop

			Cover	Art. no.
Drain body	Compatibility: For lowest installation; for installation in a concrete floor <i>Aqualift F Compact</i> , <i>Aqualift S Compact</i> and <i>Minilift S</i> (280 570X, 280 570S, 280 570XC and 280 570SC)			black grey 680 796 680 798
Drain body	Compatibility: Seal water height 50 mm; for installation in a concrete floor <i>Aqualift F Compact</i> , <i>Aqualift S Compact</i> and <i>Minilift S</i> (280 570X, 280 570S, 280 570XC and 280 570SC)			black grey 680 795 680 797
additionally <i>Multistop</i>	Compatibility: For installation in a concrete floor <i>Aqualift F Compact</i> , <i>Aqualift S Compact</i> and <i>Minilift S</i> (280 570X, 280 570S, 280 570XC and 280 570SC) Function: Odour, foam, rodent and insect stop			48 500
additionally <i>Megastop</i>	Compatibility: For installation in a concrete floor <i>Aqualift F Compact</i> , <i>Aqualift S Compact</i> and <i>Minilift S</i> (280 570X, 280 570S, 280 570XC and 280 570SC) Function: Mechanical odour trap inclusive hair filter for KESSEL upper sections			48 550
additionally odour trap	Compatibility: For installation in a concrete floor <i>Aqualift F Compact</i> , <i>Aqualift S Compact</i> and <i>Minilift S</i> (280 570X, 280 570S, 280 570XC and 280 570SC) Seal water height: 50 mm (Ventilation always required when in use!)			680 696


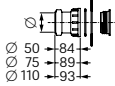


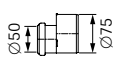

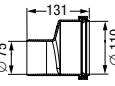

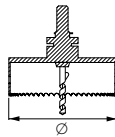


Hygiene

				Art. no.
Hair filter	Compatibility: Art. no. 48 500; for lifting station <i>Aqualift F Compact</i> , <i>Aqualift S Compact</i> and <i>Minilift S</i> (280 570X, 280 570S, 280 570XC and 280 570SC)			48 700


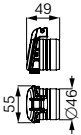







Accessories

Installation set		Outer diameter Ø (mm)	Art. no.
Installation set	<p>Compatibility: For installation in a concrete floor <i>Aqualift F Compact</i> and <i>Aqualift S Compact</i>; for installation in waterproof concrete</p> <p>Inclusive:</p> <ul style="list-style-type: none"> 1 Extension section with central flange 2 Pressure pipe set Ø 32: Art. no. 83 077 Ø 40: Art. no. 83 079 3 Adapter (Ø 75/Ø 110 socket) 4 Seal insert 5 Casing 6 Puddle flange (2) 	Ø 32	83 077
		Ø 40	83 079
			
Sealing flange set			Art. no.
for sealing against water exerting pressure from outside	<p>Compatibility: Suitable for <i>Aqualift S Compact</i> lifting station for installation in the floor slab. Diameter of waterproofing membrane: 800 mm</p> <p>Inclusive: 4 mating flange segments as well as elastomeric waterproofing membrane made of NR/SBR and screws</p>		83 078
Extension sections			Art. no.
with centre flange	<p>Compatibility: For installation in a concrete floor <i>Aqualift F Compact</i> and <i>Aqualift S Compact</i></p> <p>Additional function: For installation in waterproof concrete</p> <p>Inclusive: Temporary construction debris cover, fully assembled, gasket set (counter flange made of polymer, screwed, elastomer sealing sheet made of NK/SBR Ø 800 mm)</p> <p>Extension: Max. 360 mm</p>		83 075
with flange and counter flange	<p>Compatibility: For installation in a concrete floor <i>Aqualift F Compact</i> and <i>Aqualift S Compact</i></p> <p>Additional function: For connection to an on-site sealing sheet</p> <p>Inclusive: Screws</p> <p>Extension: Max. 140 mm (In case of deeper installation ensure maintenance capability!)</p>		83 073
with gasket	<p>Compatibility: For installation in a concrete floor <i>Aqualift F Compact</i> and <i>Aqualift S Compact</i></p> <p>Extension: Max. 180 mm (In case of deeper installation ensure maintenance capability!)</p>		83 070
for deeper installation with flange	<p>Compatibility: For installation in a concrete floor <i>Minilift S</i> (280 570X, 280 570S, 280 570XC and 280 570SC)</p> <p>Inclusive: Gasket</p> <p>Extension: Max. 147 mm (In case of deeper installation ensure maintenance capability!)</p>		830 070
Pressure pipe set		Outer diameter Ø (mm)	Art. no.
Pressure pipe set	<p>Compatibility:</p> <p>Ø 40 / Ø 50: <i>Aqualift F Compact</i>, <i>Aqualift S Compact</i></p> <p>Ø 40: <i>Minilift S</i> (280 570X, 280 570S, 280 570XC and 280 570SC)</p> <p>Inclusive: 5 m pressure pipe hose</p> <p>Ø 40 (DN 32 mm)</p> <p>Ø 50 (DN 40 mm)</p>	Ø 40	28 040
		Ø 50	28 062
			

Accessories




Inlet adaptor		Outer diameter Ø (mm)	Drill size in mm	Art. no.
with gasket and threaded ring	Compatibility: Ø 50 / Ø 75 / Ø 110: <i>Aqualift S Compact</i> Ø 50 / Ø 75: <i>Minilift S</i> (280 570X, 280 570S, 280 570XC and 280 570SC) Inclusive: Flat seal			Ø 50 60 39 005
		Ø 75 92 39 007		
		Ø 110 121 39 100		
Transition sections		Outer diameter Ø (mm)	Art. no.	
Transition section	Compatibility: For installation in a concrete floor <i>Aqualift F Compact</i> and <i>Minilift S</i> (280 570X, 280 570S, 280 570XC and 280 570SC)		Ø 40/50	681 111
	Compatibility: For installation in a concrete floor <i>Aqualift F Compact</i> , <i>Aqualift S Compact</i> and <i>Minilift S</i> (280 570X, 280 570S, 280 570XC and 280 570SC) Inclusive: Sealing ring Ø 50			Ø 50/75 27 126
	Compatibility: For installation in a concrete floor <i>Aqualift F Compact</i> , <i>Aqualift S Compact</i> and <i>Minilift S</i> (280 570X, 280 570S, 280 570XC and 280 570SC) Inclusive: Ø 110 socket / Ø 75 spigot for use as connection piece, gasket			Ø 75/110 27 602
Hole saw		Outer pipe diameter in mm	Drill size in mm	Art. no.
Hole saw set	Compatibility: Ø 50 - Ø 200: <i>Aqualift F Mono / Duo</i> , <i>Aqualift F XL</i> Ø 50 - Ø 160: <i>Aqualift S 100 / Aqualift S 200</i> Ø 50 - Ø 110: <i>Aqualift F Basic</i> , <i>Aqualift F Compact</i> , <i>Aqualift S Compact</i> Ø 50 / Ø 75: <i>Minilift S</i> (280 570X, 280 570S, 280 570XC and 280 570SC) Inclusive: Saw blade holder			Ø 50 60 500 101
				Ø 75 92 500 100
				Ø 110 121 500 100
				Ø 110 121 500 100
				Ø 125 133 500 100
				Ø 160 168 500 100
				Ø 200 ¹⁾ 200 500 102
				1) use a power drill with at least 1000 watts
Sealing		Nominal pipe diameter in mm	Outer pipe diameter in mm	Art. no.
Pipe sealing gasket	Compatibility: DN 50 - DN 200: <i>Aqualift F Mono / Duo</i> , <i>Aqualift F XL</i> DN 50 - DN 150: <i>Aqualift S 100 / Aqualift S 200</i> DN 50 - DN 100: <i>Aqualift F Basic</i> , <i>Aqualift F Compact</i> , <i>Aqualift S Compact</i> DN 50 / DN 70: <i>Minilift S</i> (280 570X, 280 570S, 280 570XC and 280 570SC) Drill size: Ø 50: 60 mm Ø 75: 92 mm Ø 110: 121 mm Ø 125: 133 mm Ø 160: 168 mm Ø 200: 210 mm			DN 50 Ø 50 850 114
				DN 70 Ø 75 850 116
				DN 100 Ø 110 850 117
				DN 125 Ø 125 850 118
				DN 150 Ø 160 850 119
				DN 200 Ø 200 850 123

Accessories

		Outer diameter Ø (mm)	Art. no.
Backflow preventer for push-fit connection			
Backflow preventer for push-fit connection	<p>Compatibility: For systems for outdoor installation, for push-fitting into an inlet Ø 50 for lifting station <i>Minilift S</i> (280 570X, 280 570S, 280 570XC and 280 570SC)</p> <p>Function: Prevents potential backflow in the inlet pipe</p>	Ø 50	28 093
	 		
Click adapter			
Click adapter	<p>Compatibility: For changeover to PE connection; for lifting station <i>Aqualift F Compact</i>, <i>Aqualift S Compact</i> and <i>Minilift S</i> (280 570X, 280 570S, 280 570XC and 280 570SC)</p>	Ø 40	28 086
			
Adapter set			
Adapter set	<p>Compatibility: Lifting station <i>Aqualift S 100 & 200</i></p> <p>Function: Optional set facilitating external pipe connection</p> <p>Contain: Adapter with internal thread 2" and a fitting with external thread 2" and quick-connection ending for easy installation</p>		28 097
			
Control unit accessories			
Audible alarm	<p>Compatibility: For all control units 230 V not for warning devices Art. no. 20 222 and 20 223</p> <p>Cable length: 20 m</p>		20 162
			
Potential-free contact	<p>Compatibility: For all control units 230 V not for warning devices Art. no. 20 222 and 20 223</p>		80 072
			
Safety			
TeleControl telemetric system	<p>Compatibility: For connection to KESSEL Comfort control units 230 Volt and 400 Volt</p> <p>Function: Relaying of full text messages to up to three mobile phones</p> <p>Inclusive: With internal antenna (without SIM card)</p>		28 792
			
Antenna booster with magnetic base	<p>Compatibility: For <i>TeleControl</i> telemetric system to improve the reception</p> <p>Cable length: 2.5 m</p>		28 793
			
Extension cable	<p>Compatibility: For antenna booster</p> <p>Cable length: 2 m</p>		28 794
Air compressor set	<p>Function: For use in combination with lifting station and pumping stations with pressure control: prevents soiling, avoids the formation of condensate in the pressure hose, makes operation of systems possible with pressure hose lengths > 10 m – 30 m</p> <p>Inclusive: T-piece connection, 20 m pressure hose</p>		28 048
			
PE-pressure hose extension (per meter)	<p>Compatibility: For Art. no. 28 048</p>		680 071

Accessories

Level sensor

			Art. no.
Level sensor with immersion pipe 433 mm	Compatibility: For <i>Aqualift F XL</i>		681 040
	Cable length: 10 m		
	Cable length: 30 m		681 041
Level sensor with immersion pipe 288 mm	Compatibility: For <i>Aqualift F Duo</i>		681 042
	Cable length: 10 m		
	Cable length: 30 m		681 043
Level sensor with immersion pipe 181 mm	Compatibility: For <i>Aqualift F Mono</i>		681 046
	Cable length: 10 m		
	Cable length: 30 m		681 047

Cover plates

			Cover	Art. no.	
Surface water tight	<p>Compatibility: For installation in a concrete floor <i>Aqualift F Compact</i>, <i>Aqualift S Compact</i> and <i>Minilift S</i> (280 570X, 280 570S, 280 570XC and 280 570SC)</p> <p>Inclusive: Gasket</p> <p>Version recessed for on-site tiling, grey: For tile thicknesses of 18 mm (Ventilation always required when in use!)</p>			tileable	830 052
				black	830 050


Accessories

Upgrade set

			Art. no.
Alarm float switch	<p>Compatibility: Can be combined with 230 V Comfort control units; for lifting station <i>Aqualift F Compact</i></p> <p>Inclusive: Float switch, float switch bracket</p> <p>Cable length: 5 m</p>		28 016
	<p>Compatibility: For use with 230 V and 400 V Comfort control units; for lifting station <i>Aqualift F Mono/Duo</i></p> <p>Inclusive: Float switch, support plate, cover</p> <p>Cable length: 5 m</p>		28 015
	<p>Compatibility: For use with 230 V and 400 V Comfort control units</p> <p>Inclusive: Float switch, support plate, cover</p> <p>Cable length: 5 m</p>		28 014

Cable extensions


for extension from 15 m or 25 m (cable length delivered: 5 m)

	Lifting station <i>Aqualift F Mono</i> <i>Aqualift F Compact Mono</i> <i>Aqualift S Compact Mono</i> <i>Aqualift S 100 Mono</i> <i>Aqualift S 100 Mono Tronic</i>	Lifting station <i>Aqualift F Duo</i> <i>Aqualift F Compact Duo</i> <i>Aqualift S Compact Duo</i> <i>Aqualift S 100 Duo Tronic</i> <i>Aqualift S 200 Duo Tronic</i>		Art. no.
Cable extension for probe (10 m)	<p>Extension to 15 m: 1×80 889</p> <p>Extension to 25 m: 2×80 889</p>	<p>Extension to 15 m: 1×80 889</p> <p>Extension to 25 m: 2×80 889</p>		80 889
Cable extension for pump (10 m)	<p>Extension to 15 m: 1×80 891</p> <p>Extension to 25 m: 2×80 891</p>	<p>Extension to 15 m: 2×80 891</p> <p>Extension to 25 m: 4×80 891</p>		80 891

Inlet socket

			Outer diameter Ø (mm)	Art. no.
Inlet socket	<p>Compatibility: For <i>Aqualift S 100 / Aqualift S 200</i> lifting station</p> <p>Inclusive: Lip seal and three PT screws for fixing</p>		Ø 110	680 986
			Ø 160	680 987

Flexible pressure pipe connection

			Outer diameter Ø (mm)	Art. no.
for manual diaphragm pump	<p>Compatibility: For PE pipe connections; for lifting station <i>Aqualift F Basic</i>, <i>Aqualift F Mono / Duo</i> and <i>Aqualift F XL</i></p> <p>Inclusive: Two hose clamps</p> <p>Length: 200 mm</p>		Ø 32	28 660
for ventilation	<p>Compatibility: For PE pipe connections; for <i>Aqualift F Basic</i>, <i>Aqualift F Mono / Duo</i> and <i>Aqualift F XL</i></p> <p>Inclusive: Two hose clamps</p> <p>Length: 200 mm</p>		Ø 70	28 661
for connection adapter and pressure pipes	<p>Compatibility: For PE pipe connections; for <i>Aqualift F Mono / Duo</i> and <i>Aqualift F XL</i>; Art. no. 28 663: <i>Aqualift F Basic</i></p> <p>Inclusive: Two hose clamps</p> <p>Length: 200 mm</p>		Ø 90	28 662
			Ø 110	28 663

Accessories

Closure valves		Outer diameter Ø (mm)	Art. no.
Closure valve, vertical	<p>Compatibility: For lifting station <i>Aqualift F Basic</i>, <i>Aqualift F Mono / Duo</i> and <i>Aqualift F XL</i></p> <p>Function: For the pressure pipe of KESSEL lifting stations with plastic fitting; for connection to pressure pipe, a KESSEL flange connector or adapter is required.</p> <p>Inclusive: Gasket, screw</p>	Ø 90	28 715
Closure valve with flange adaptor, vertical	<p>Compatibility: For lifting station <i>Aqualift F Basic</i>, <i>Aqualift F Mono / Duo</i> and <i>Aqualift F XL</i></p> <p>Function: For the pressure pipe of KESSEL lifting stations with plastic fitting</p> <p>Inclusive: With screwed flange adaptor, for connection to a standard flange DN 80 according to DIN 2501 (without sealing gasket and screw)</p>	Ø 90	28 716
Closure valve	<p>Compatibility: With lateral pressure pipe for lifting stations <i>Aqualift F</i></p>	Ø 90 Ø 110	28 682 28 683
	<p>Compatibility: For installation on the inlet side (no pressure) for lifting stations <i>Aqualift F</i></p>	Ø 110 Ø 160	28 698 28 699
Connection flange		Outer diameter Ø (mm)	Art. no.
in PE	<p>Compatibility: For KESSEL plastic fittings; for lifting station <i>Aqualift F XL</i></p>	Ø 90	28 713
	<p>Compatibility: For KESSEL plastic fittings; for <i>Aqualift F Basic</i> and <i>Aqualift F XL</i>; also in combination with closure valve Art. no. 28 715</p> <p>Function: Spigot end for DN 100 pressure pipe connection</p>	Ø 110	28 712
Manual diaphragm pump 1 1/2 inch			Art. no.
Manual diaphragm pump in cast iron	<p>Compatibility: For manually pumping wastewater; for lifting station <i>Aqualift F Mono / Duo</i> and <i>Aqualift F XL</i></p> <p>Inclusive: With a ball valve on inlet and outlet side</p>		28 680
Flange adaptor		Outer diameter Ø (mm)	Art. no.
in PE	<p>Compatibility: From KESSEL fitting to standard flange; for lifting station <i>Aqualift F XL</i></p>	DN 80	28 714
in cast iron	<p>Compatibility: For use with cast iron pressure pipes; for lifting station <i>Aqualift F XL</i></p> <p>Function: Adaptor from DN 80 to DN 100</p> <p>Inclusive: Flange according to DIN 2501</p>	-	28 068

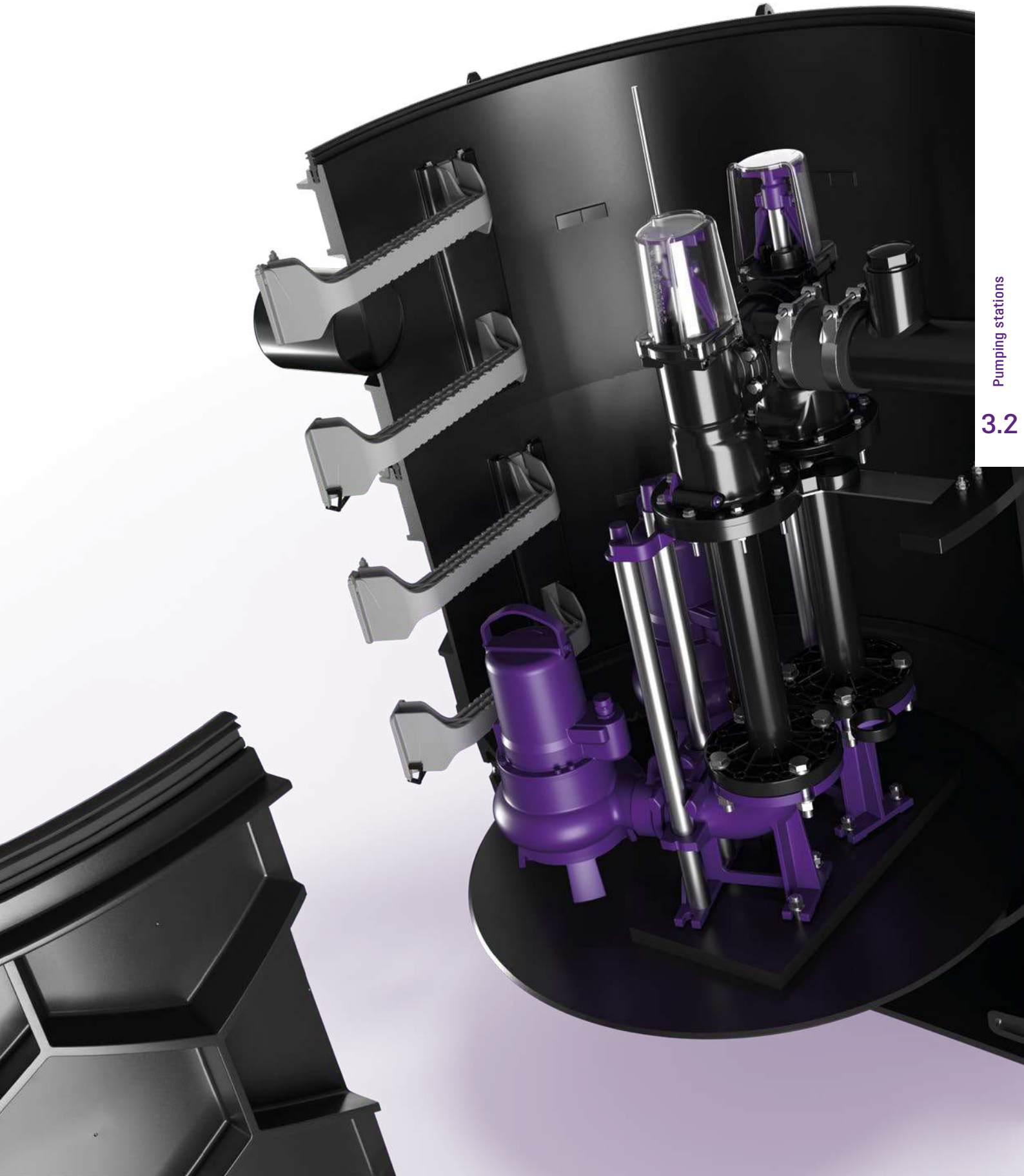
Accessories

Backflow preventer		Outer diameter Ø (mm)	Art. no.
in cast iron	<p>Compatibility: For lifting station <i>Aqualift F XL</i></p> <p>Inclusive: DN 80 flange according to DIN 2501, backflow preventer with flap and flap opening lever</p>	DN 80	28 021
			
Connection adaptor		Outer diameter Ø (mm)	Art. no.
in cast iron	<p>Compatibility: For connection from lifting station <i>Aqualift F XL</i> to on-site pressure pipe. Fits PE pressure pipes</p> <p>Inclusive: Flange according to DIN 2501, single gasket</p> <p>Outer diameter: DN 80: OD 90 mm DN 100: OD 110 mm</p>	Ø 90	28 067
			
		Ø 110	28 020
			
Gate closure valve		Outer diameter Ø (mm)	Art. no.
in cast iron	<p>Compatibility: For lifting station <i>Aqualift F XL</i></p> <p>Inclusive: DN 80 flange according to DIN 2501, gate closure valve including closure wheel</p>	DN 80	28 041
			
Y-Coupling		Outer diameter Ø (mm)	Art. no.
in cast iron	<p>Compatibility: For lifting station <i>Aqualift F XL</i></p> <p>Inclusive: DN 80 (OD 80 mm) flange according to DIN 2501</p>	Ø 80	28 042
			
Sealing gasket		Outer diameter Ø (mm)	Art. no.
Sealing gasket (rubber)	<p>Compatibility: Flange according to DIN 2501, for pressure pipe connections; for lifting station <i>Aqualift F XL</i></p>	DN 80	28 043
			
Bolt set M16	<p>Compatibility: For Art. no. 28 043 and 28 044</p> <p>Inclusive: 4 bolts, 4 nuts, 8 washers</p>		28 078

3.2 Pumping stations

For installation in a floor slab
or outdoor / underground installation





This is how it's done

Planning a pumping station

1 Select a system base with suitable pump capacity

Always the right choice: 
kessel.com/smartselect

Determine the required pump capacity (e.g. with the calculation module from SmartSelect) and select the corresponding system base with the help of the power diagram.

 **System bases:** From page 152

2 Select a system chamber with suitable cover

Depending on the installation situation, when installing underground or in a floor slab, the system chamber can be combined with different upper sections and covers. From class K 3 to class D. In addition, you can also choose between the 600 mm diameter and 800 mm diameter access openings (note that a minimum inlet depth of 1,780 mm is required for the 600 mm access opening).



Inlet Ø 600

Inlet Ø 800

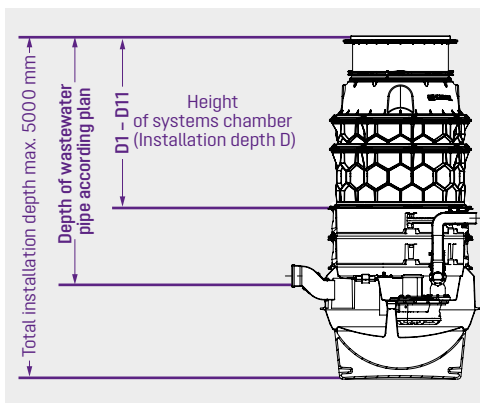
For 600 mm diameter access openings

an inlet depth of at least 1.780 mm is required for maintenance.

Class D installations require a concrete load distribution plate if road surface does not provide proper load distribution.

3 Calculate the height of the system chamber (D)

Now determine the required chamber depth for underground installation or for installation in the floor slab. Take the inlet depth from the top surface of the cover to the bottom of the inlet pipe from your drainage plan.



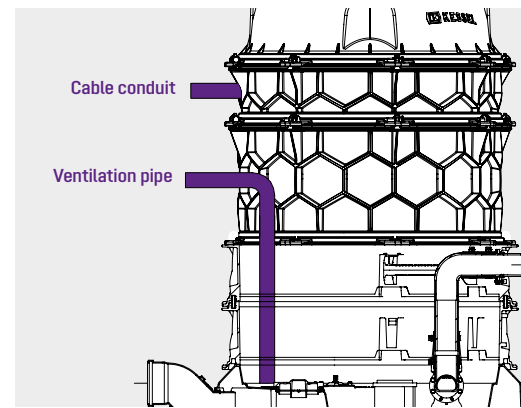
Subtract the height of the system base (height from top to the lower edge of the inlet) from the inlet depth taken from the drainage plan and you have the height of the required engineering chamber. Now you can select a module with the corresponding height and the required cover from the article list. Please note the maximum permissible total installation depth of 5.000 mm and the groundwater resistance of KESSEL engineering chambers of 3.000 mm.

Note: check on-site max groundwater levels

4 Note: Connection pipe for cables and ventilation

During planning, please also note the following:

- The maximum cable length is 30 m.
- Stipulate that the **ventilation pipe** and the **cable conduit** must be laid with a continuous incline (to allow water to flow back into the pump station).



➤ **Optional cable conduit sealing kit: page 168**

Data sheets

On our website www.kessel.com: Enter the article number you have selected and we provide you with detailed data sheets to download.

Pumping station *Aquapump XXL*

The powerful solution for extremely large amounts of water.

It couldn't be more powerful. The *Aquapump XXL* can even cope with large quantities of wastewater and is particularly suitable for commercial and industrial use thanks to its overall size. The pumping station has been designed as a modular system and can be variably combined with technical and chamber modules. The *Aquapump XXL* is groundwater-resistant to a depth of 3,000 mm.

The pumping station is available as a Mono or Duo system with particularly powerful pumps with an input power of up to 11 kW. A Comfort control unit can optionally be added.



Flexible installation

Thanks to the modular design with a large selection of chamber modules and upper sections, the pumping station can be installed both underground and in a floor slab. Our standard engineering chambers are groundwater-resistant up to three metres and can be built up to a height of five metres.

Engineering systems base *Aquapump XXL Mono / Duo*

Wet installation, for wastewater without or without sewage



CE EN 12050-1

Tank volume: 1800 liters
 Pump volume: max. 900 liters

Polyethylene system base (corrugated chamber)
 for underground installation, resistant to aggressive media. With Ø 160 mm inlet. For connection to Ø 1000 mm system chamber. Handles groundwater depths up to 3.000 mm.

With **single or twin removable wastewater pump(s)**

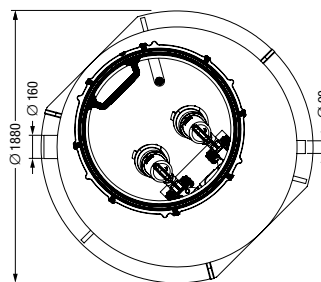
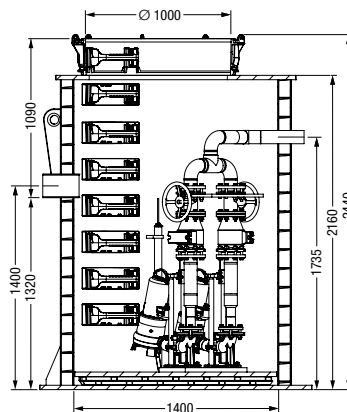
- with macerator (STZ)
- with multi-vane impeller (GTF)
- single-channel impeller (GTK)

for wastewater with or without sewage (without ATEX requirements). With hydrostatic sensor for level measurement. Pressure pipe Ø 90 mm outside diameter (welded PE pipe is to be used for the pressure pipe), including backflow preventer and closure valve on pressure pipe side. Power cable length: 10 m (30 m on request).

Control unit

With control unit with self-diagnosis system (SDS), battery buffering and logbook function, control unit is splashproof (IP 54).

- **Installation:** in combination with system chambers page 156 – 157
- **Accessories:** pages 167 – 170



Mono version with one pump

STZ pump	Pumping volume in liters	Voltage	Art. no.
4400-S1*	820	400 V	874 30 35
5200-S1*	820	400 V	874 30 36
7500-S1*	820	400 V	874 30 37
11000-S1*	820	400 V	874 30 38

GTF pump	Pumping volume in liters	Voltage	Art. no.
5200-S1	900	400 V	874 30 43

GTK pump	Pumping volume in liters	Voltage	Art. no.
5200-S1	900	400 V	874 30 45

Duo version with two pumps

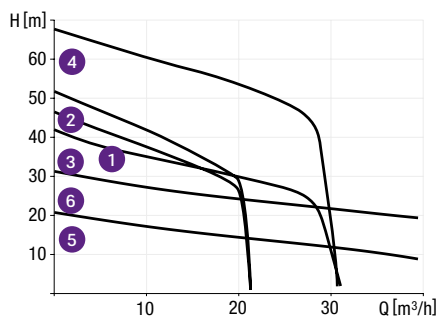
STZ pump	Pumping volume in liters	Voltage	Art. no.
4400-S1*	800	400 V	874 30 39
5200-S1*	800	400 V	874 30 40
7500-S1*	800	400 V	874 30 41
11000-S1*	800	400 V	874 30 42

GTF pump	Pumping volume in liters	Voltage	Art. no.
5200-S1	880	400 V	874 30 44

GTK pump	Pumping volume in liters	Voltage	Art. no.
5200-S1	880	400 V	874 30 46

* ATEX version

Pumping capacity



Pump type

	Voltage	Amperage	Input Power (P1)	Power (P2)	Pumping capacity	Pumping height
1 STZ 4400-S1*	400 V	7.5 A	4.4 kW	3.7 kW	21.3 m³/h	46.7 m
2 STZ 5200-S1*	400 V	8.7 A	5.2 kW	4.4 kW	21.3 m³/h	52 m
3 STZ 7500-S1*	400 V	13 A	7.5 kW	6.4 kW	30.7 m³/h	42 m
4 STZ 11000-S1*	400 V	18.8 A	11 kW	9.5 kW	30.6 m³/h	68 m
5 GTF 5200-S1*	400 V	8.7 A	5.2 kW	4.4 kW	52.8 m³/h	21 m
6 GTK 5200-S1*	400 V	8.7 A	5.2 kW	4.4 kW	51.6 m³/h	31.6 m

* Definition of S1-pumps see page 101

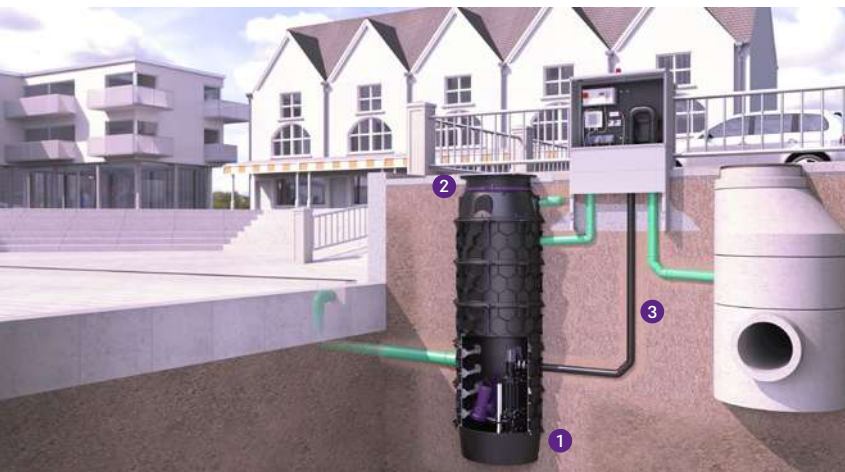


Pumping station *Aquapump XL*

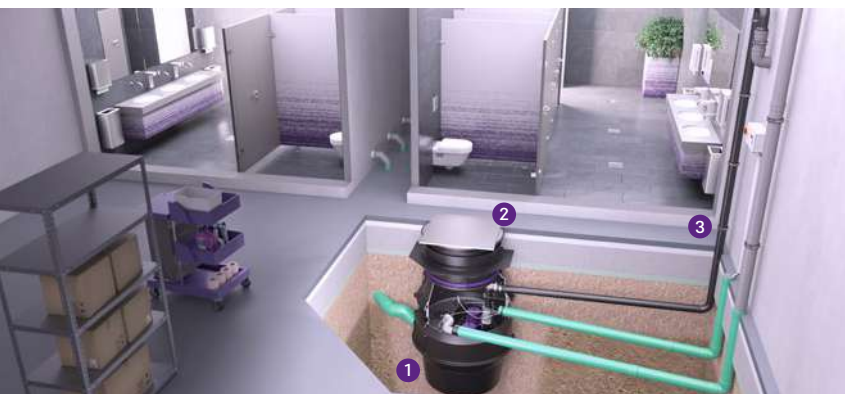
The powerful version for commercial, industrial and communal applications.

For the highest demands: the *Aquapump XL* can cope with large quantities of wastewater containing sewage and is therefore suitable not only for typical residential buildings but also particularly for commercial and industrial use. The pumping station has been designed as a modular system and can be combined with the appropriate KESSEL chamber system.

The *Aquapump XL* is available as a Mono or Duo system with pumps in different capacity classes. A wide selection of upper sections and covers ensure that the pumping station can be installed flexibly at different installation locations.



1 Pumping station 2 Engineering chamber 3 Pressure pipe



1 Pumping station 2 Engineering chamber 3 Pressure pipe

Pumping stations 60 Hz/400 V, dry installation

Now also available in 60 Hz for more information contact us at info@kessel.com



Maximum reliability

The intelligent control unit with integrated self-diagnosis system SDS and battery buffering continually monitors all electrical components and keeps an electronic operating log which can be read out.

Dry installation

easy, clean servicing

In comparison with wet installation, dry installation offers mainly hygienic advantages for maintenance and repair, since the pumping station has a separate collecting chamber. In addition, these dry installation systems do not require ATEX pumps.



Wet installation

available in ATEX version



The pumps can be operated in potentially explosive areas – this means at locations where explosive gases may occur due to wastewater and/or light liquids with sewage.



Flexible installation

Thanks to the modular design with a large selection of chamber modules and upper sections, the pumping station can be installed both in the ground and in a floor slab. The systems are groundwater-resistant to a depth of 3.000 mm.

If you want to use the *Aquapump XL* inside the building:

➤ [Lifting station *Aqualift F XL*: page 110](#)

Engineering systems base *Aquapump XL Mono / Duo*

Wet installation, for wastewater without or without sewage



EN 12050-1 ATEX version

Tank volume: 680 liters

Pump volume: max. 310 liters

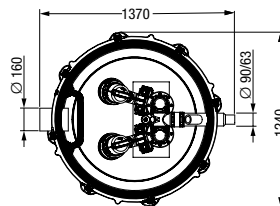
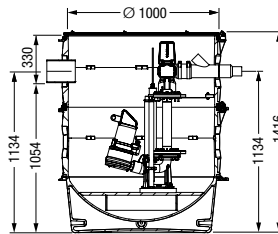
Polyethylene system base for underground installation, resistant to aggressive media. With \varnothing 160 mm inlet. For connection to \varnothing 1000 mm system chamber. Handles groundwater depths up to 3.000 mm.

With **single or twin removable wastewater pump(s)** with macerator for wastewater with or without sewage. With hydrostatic sensor for level measurement. Pressure pipe \varnothing 63/90 mm outside diameter (welded PE pipe is to be used for the pressure pipe), including backflow preventer and closure valve on pressure pipe side. Power cable length: 10 m (30 m on request).

Control unit

With control unit with self-diagnosis system (SDS), battery buffering and logbook function, control unit is splashproof (IP 54).

- **Installation:** in combination with system chambers page 156 – 157
- **Accessories:** pages 167 – 170



Mono version with one macerator pump

STZ pump	Pumping volume in liters	Voltage	Art. no.
1300-S1	310	400 V	874 30 14
2500-S1	310	400 V	874 30 15
3700-S1	310	400 V	874 30 16

Duo version with two macerator pumps

STZ pump	Pumping volume in liters	Voltage	Art. no.
1300-S1	300	400 V	874 30 17
2500-S1	300	400 V	874 30 18
3700-S1	300	400 V	874 30 19

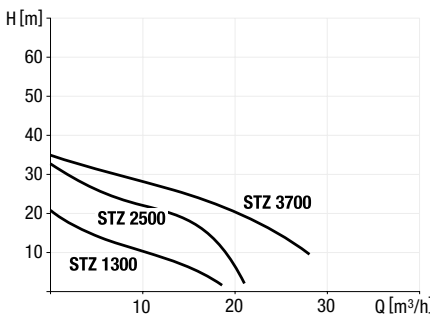
Engineering systems base *Aquapump XL* in combination with system chamber \varnothing 1000

Access opening \varnothing 600

Access opening \varnothing 800



Pumping capacity



Pump type

Pump type	Voltage	Amperage	Input Power (P1)	Power (P2)	Pumping capacity	Pumping height
STZ 1300-S1	400 V	2.5 A	1.3 kW	0.9 kW	20 m³/h	21 m
STZ 2500-S1	400 V	4.4 A	2.5 kW	1.9 kW	21 m³/h	33 m
STZ 3700-S1	400 V	6.4 A	3.7 kW	3.1 kW	28 m³/h	35 m

* Definition of S1-pumps see page 101



Always the right choice:
kessel.com/smartselect

Engineering systems base *Aquapump XL Mono / Duo* Wet installation, for wastewater without or without sewage



EN 12050-1 EN 12050-2

Tank volume: 680 liters

Pump volume: max. 350 liters

Polyethylene system base for underground installation, resistant to aggressive media. With \varnothing 160 mm inlet. For connection to \varnothing 1000 mm system chamber. Handles groundwater depths up to 3.000 mm.

With **single or twin removable wastewater pump(s)**

- with multi-vane impeller (GTF)

- single-channel impeller (GTK)

for wastewater with or without sewage (without ATEX requirements). With float switch / hydrostatic sensor for level measurement. Pressure pipe \varnothing 63/90 mm outside diameter (welded PE pipe is to be used for the pressure pipe), including backflow preventer and closure valve on pressure pipe side.

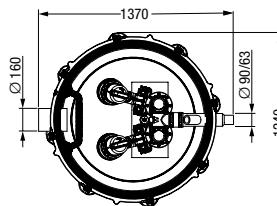
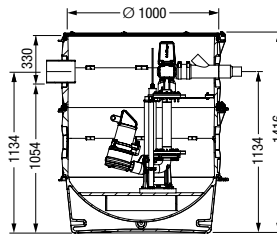
Power cable length: 10 m (30 m on request).

Control unit

With control unit (versions with hydrostatic sensor) with self-diagnosis system (SDS), battery buffering and logbook function, control unit is splashproof (IP 54).

➤ **Installation:** in combination with system chambers page 156 – 157

➤ **Accessories:** pages 167 – 170



Mono version with one pump

GTF pump	Pumping volume in liters	Voltage	Art. no.
1400-S1**	340	230 V	874 30 32
1400-S1	340	230 V	874 30 33
1400-S1	340	400 V	874 30 47
1600-S1	350	400 V	874 30 20
2600-S1	350	400 V	874 30 21
4000-S1	350	400 V	874 30 22

GTK pump	Pumping volume in liters	Voltage	Art. no.
1300-S1	350	400 V	874 30 26
2600-S1	350	400 V	874 30 27
3700-S1	350	400 V	874 30 28

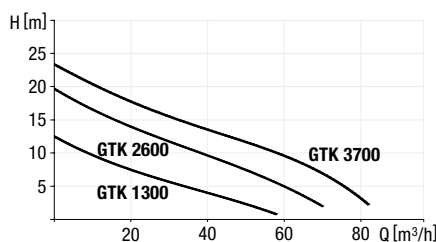
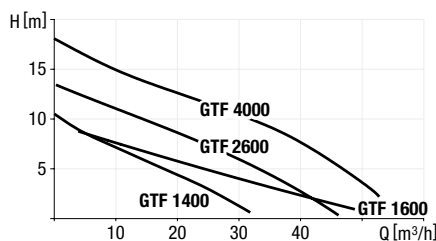
Duo version with two pumps

GTF pump	Pumping volume in liters	Voltage	Art. no.
1400-S1	340	230 V	874 30 34
1400-S1	340	400 V	874 30 48
1600-S1	340	400 V	874 30 23
2600-S1	340	400 V	874 30 24
4000-S1	340	400 V	874 30 25

GTK pump	Pumping volume in liters	Voltage	Art. no.
1300-S1	340	400 V	874 30 29
2600-S1	340	400 V	874 30 30
3700-S1	340	400 V	874 30 31

** Version with float switch

Pumping capacity



Pump type

Pump type	Voltage	Amperage	Input Power (P1)	Power (P2)	Pumping capacity	Pumping height
GTF 1400-S1*	230 V	6.5 A	1.5 kW	1.1 kW	31 m³/h	10.5 m
GTF 1600-S1*	400 V	2.9 A	1.6 kW	1.2 kW	49 m³/h	9.3 m
GTF 2600-S1*	400 V	4.5 A	2.6 kW	2.1 kW	46 m³/h	13.6 m
GTF 4000-S1*	400 V	6.6 A	4.0 kW	3.4 kW	53 m³/h	18 m

* Definition of S1-pumps see page 97

Pump type

Pump type	Voltage	Amperage	Input Power (P1)	Power (P2)	Pumping capacity	Pumping height
GTK 1300-S1*	400 V	2.5 A	1.3 kW	1.0 kW	57 m³/h	12.4 m
GTK 2600-S1*	400 V	4.9 A	2.6 kW	2.1 kW	71 m³/h	19.6 m
GTK 3700-S1*	400 V	6.5 A	3.7 kW	3.1 kW	82 m³/h	23.5 m

* Definition of S1-pumps see page 101



Engineering systems base *Aquapump XL Mono / Duo*

Wet installation, for wastewater without sewage and rainwater



EN 12050-2

Tank volume: 680 liters

Pump volume: approx. 100 liters

Base and inlet / outlet made of PE
For installation in a concrete slab and for outdoor underground installation in combination with system chamber.

Version:

- For wastewater without sewage
- Pump station *Aquapump XL Mono / Duo* with welded on chamber ring
- With multi-vane impeller
- Inlet Ø 160 mm
- Pressure pipe connection Ø 40 mm
- Backflow preventer
- Closure valve on pressure pipe side
- Pressure sensor

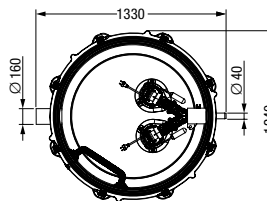
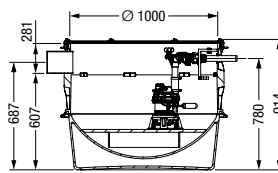
Cable length: 10 m (30 m on request)

Installation:

Handles groundwater depths up to 3.000 mm

➤ **Installation:** in combination with system chambers page 156 – 157

➤ **Accessories:** pages 167 – 170



Mono version with one pump

GTF pump	Pumping volume in liters	Voltage	Art. no.
----------	--------------------------	---------	----------

With float switch

600-S1	90	230 V	874 30 04
1200-S3	100	230 V	874 30 09

With SDS control unit and pneumatic level measurement (with pressure sensor)

600-S1	90	230 V	874 30 05
1200-S3	100	230 V	874 30 10

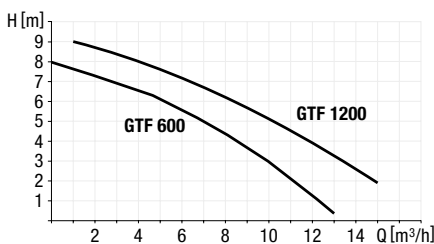
Duo version with two pumps

GTF pump	Pumping volume in liters	Voltage	Art. no.
----------	--------------------------	---------	----------

With SDS control unit and pneumatic level measurement (with pressure sensor)

600-S1	90	230 V	874 30 07
1200-S3	100	230 V	874 30 12

Pumping capacity



Pump type

Current type	Voltage	Amperage	Power (P1/P2)	Rpm	Motor protection	Protection	Pumping capacity	Pumping height
GTF 600-S1*	230 V	2.9 A	650 W / 400 W	2.800 min ⁻¹	integrated	IP 68	12 m³/h	8 m
GTF 1200-S3-50%*	230 V	4.9 A	1180 W / 720 W	2.800 min ⁻¹	integrated	IP 68	15.5 m³/h	9 m

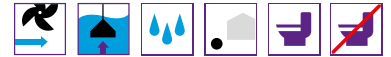
* Definition of S1 and S3-pumps see page 101

Access opening Ø 600

Access opening Ø 800



Engineering system base *Aquapump XL Mono / Duo* Dry installation, for wastewater with or without sewage



EN 12050-1

Tank volume: 335 liters

Pump volume: 160 liters

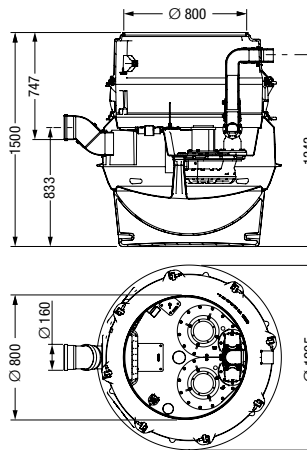
Polyethylene system base for underground installation, resistant to aggressive media. With \varnothing 160 mm inlet. For connection to \varnothing 800 mm upper sections. Handles groundwater depths up to 3.000 mm.

With **single or twin removable wastewater pump(s)** with multi-vane impeller for wastewater with or without sewage. Dry installation. With pneumatic level measurement. Pressure pipe \varnothing 90 mm outside diameter (welded PE pipe is to be used for the pressure pipe), including backflow preventer and closure valve on pressure pipe side. Power cable length: 10 m.

Control unit

With control unit with self-diagnosis system (SDS), battery buffering and logbook function, control unit is splashproof (IP 54). 230 V-versions ready to plug in.

- **Installation:** in combination with upper section \varnothing 800 page 158
- **Accessories:** page 167 – 170
- **Note:** page 145 (60 Hz/400 V)



Mono version with one pump

SPF pump	Voltage	Art. no.
1400-S3	230 V	874 20 12
1500-S3	400 V	874 20 13
3000-S3	400 V	874 20 14
4500-S3	400 V	874 20 15

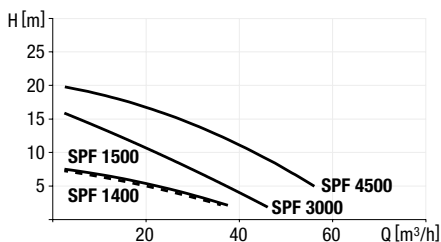
Duo version with two pumps

SPF pump	Voltage	Art. no.
1400-S3	230 V	874 20 16
1500-S3	400 V	874 20 17
3000-S3	400 V	874 20 18
4500-S3	400 V	874 20 19
1400-S1	230 V	874 20 20
1500-S1	400 V	874 20 21
3000-S1	400 V	874 20 22
4500-S1	400 V	874 20 23

Engineering systems base *Aquapump XL* in combination with an upper section \varnothing 800



Pumping capacity



Pump type

Pump type	Voltage	Amperage	Input Power (P1)	Power (P2)	Pumping capacity	Pumping height
SPF 1400-S1/S3-100/50%*	230 V	7.3 A	1.6 kW	1.1 kW	38 m³/h	7 m
SPF 1500-S1/S3-100/50%*	400 V	2.7 A	1.4 kW	1.1 kW	40 m³/h	8 m
SPF 3000-S1/S3-100/50%*	400 V	5.4 A	3.2 kW	2.7 kW	47 m³/h	16 m
SPF 4500-S1/S3-100/50%*	400 V	7.5 A	4.5 kW	3.7 kW	55 m³/h	20 m

* Definition of S1 and S3-pumps see page 101



Engineering systems base *Aquapump XL Mono / Duo*

Dry installation, for wastewater with or without sewage



EN 12050-1

Tank volume: 335 liters

Pump volume: 160 liters

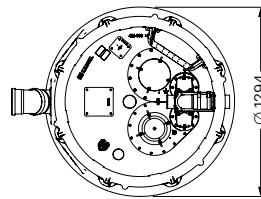
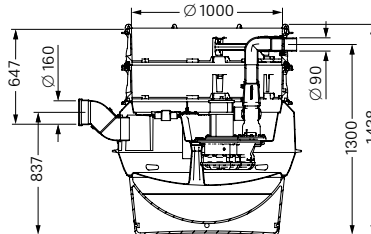
Polyethylene system base for underground installation, resistant to aggressive media. With \varnothing 160 mm inlet. For connection to \varnothing 1000 mm system chamber. Handles groundwater depths up to 3.000 mm.

With **single or twin removable wastewater pump(s)** with multi-vane impeller for wastewater with or without sewage. Dry installation. With pneumatic level measurement. Pressure pipe \varnothing 90 mm outside diameter (welded PE pipe is to be used for the pressure pipe), including backflow preventer and closure valve on pressure pipe side. Power cable length: 10 m.

Control unit

With control unit with self-diagnosis system (SDS), battery buffering and logbook function, control unit is splashproof (IP 54). 230 V-versions ready to plug in.

- **Installation:** in combination with system chambers page 156 – 157
- **Accessories:** pages 167 – 170
- **Note:** page 145 (60 Hz/400 V)



Mono version with one pump

SPF pump	Voltage	Art. no.
1400-S3	230 V	874 20 00
1500-S3	400 V	874 20 01
3000-S3	400 V	874 20 02
4500-S3	400 V	874 20 03

Duo version with two pumps

SPF pump	Voltage	Art. no.
1400-S3	230 V	874 20 04
1500-S3	400 V	874 20 05
3000-S3	400 V	874 20 06
4500-S3	400 V	874 20 07
1400-S1	230 V	874 20 08
1500-S1	400 V	874 20 09
3000-S1	400 V	874 20 10
4500-S1	400 V	874 20 11

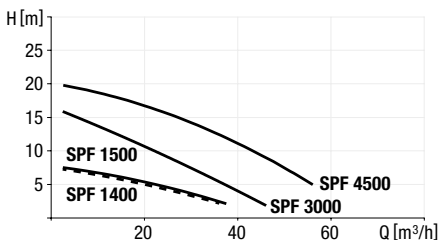
Engineering systems base *Aquapump XL* in combination with system chamber \varnothing 1000

Access opening \varnothing 600

Access opening \varnothing 800



Pumping capacity



Pump type

Pump type	Voltage	Amperage	Input Power (P1)	Power (P2)	Pumping capacity	Pumping height
SPF 1400-S1/S3-100/50%*	230 V	7.3 A	1.6 kW	1.1 kW	38 m³/h	7 m
SPF 1500-S1/S3-100/50%*	400 V	2.7 A	1.4 kW	1.1 kW	40 m³/h	8 m
SPF 3000-S1/S3-100/50%*	400 V	5.4 A	3.2 kW	2.7 kW	47 m³/h	16 m
SPF 4500-S1/S3-100/50%*	400 V	7.5 A	4.5 kW	3.7 kW	55 m³/h	20 m

* Definition of S1 and S3-pumps see page 101



Always the right choice:

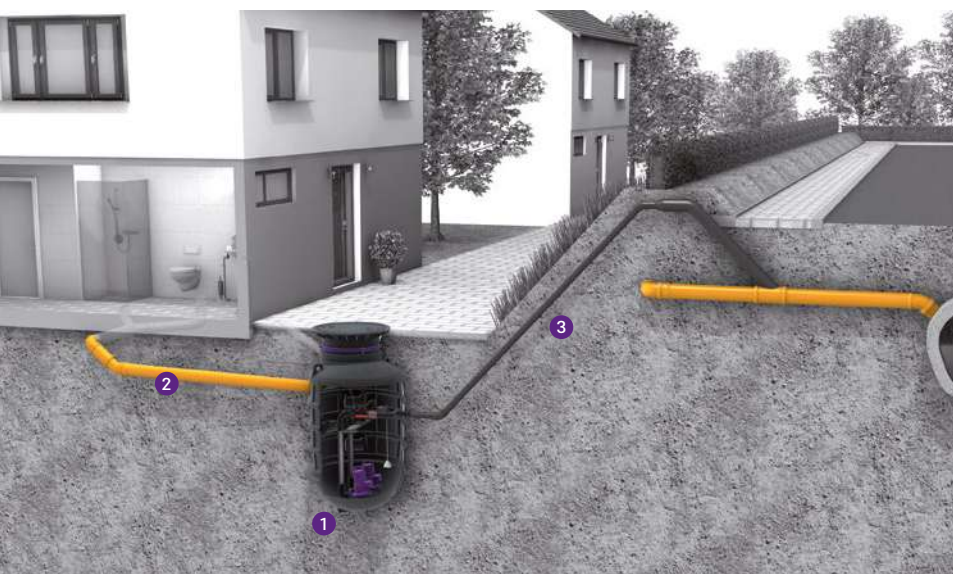
kessel.com/smartselect

Pumping station *Aquapump XL Basic*

The economical solution for larger quantities of wastewater with sewage.

Best quality at a fair price: The *Aquapump XL Basic* pumping station for underground installation is the cost-effective solution for detached houses and apartment buildings to dispose of wastewater with sewage.

The model is available as a Mono and Duo system in installation depths of 1,850 mm and 2,350 mm. Always there: a control unit for the control of the pump or pumps – including an alarm function and pressure sensor.



- 1 Pumping station *Aquapump XL Basic*
- 2 Inlet connection
- 3 Pressure pipe

100% waterproof and odour-tight

Like all KESSEL chambers, the tank of the *Aquapump XL Basic* pumping station is also absolutely waterproof and odour-tight. This is what we stand for with our guarantee that we have voluntarily extended to 20 years.

Integrated backflow preventer

All variants are equipped with a backflow preventer as standard.

Tool-free maintenance

The pump(s) is/are particularly easy to remove and maintain thanks to quick-release closures.

Powerful and efficient.

The pumping station has either one or two type AP 501 pumps. The non-clogging multi-vane vortex impeller provides for added safety.

Pumping station *Aquapump XL Basic Mono/Duo*

Wet installation, for wastewater with or without sewage



New

The pumping station for wastewater with or without sewage is suitable for underground installation and is equipped with a backflow preventer for the pressure pipe. The PE tank is resistant to domestic wastewater and includes a pedestrian class polymer cover plate. The pump with multi-vane impeller ensures maximum operating reliability. Quick-release closures enable the integrated components to be removed easily. The components are pre-assembled for final assembly on site. Including openings for inlet, ventilation and cable duct.

Type of wastewater: wastewater with sewage

Installation situation: underground installation

Backflow preventer: integrated

General characteristics:

Colour: black

Standard: EN 12050-1

Dimensions (LxW): 1,260x1,220 mm

Tank:

Inlet nominal size (DN/OD): 90/100 mm

Pumping volume: 200 l

Pressure pipe connection (DN/OD): 50 mm/63 mm

Mains frequency: 50 Hz

Operating mode: S1

Speed: 2,900 U/min

Type of fuse required (electrical protection): C 16 A

Max. temperature (permanent) of conveyed material: 40 °C

Impeller type: Multi-vane impeller

Length of mains cable for pump: 10 m

Protection class (pump): IP 68

Temperature monitoring: integrated

Comfort Control unit:

Self-diagnosis system (SDS): yes

Battery buffering: yes

Potential-free contact: optional

Protection class control unit: IP 54

Connection type: Schuko (earthed contact) 2-pin

Length of mains cable for control unit: 1.45 m

Type of level measurement: pneumatic

Level measurement instrument: Pressure sensor

Accessories: pages 167 – 170

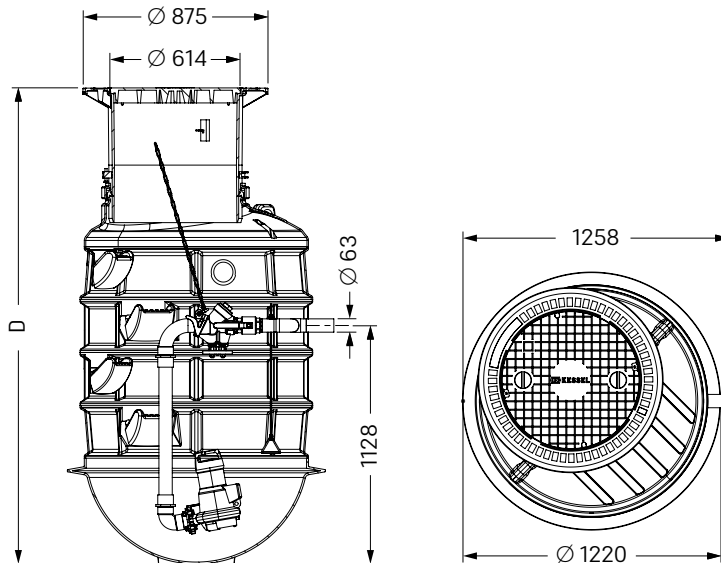


Mono version with one pump

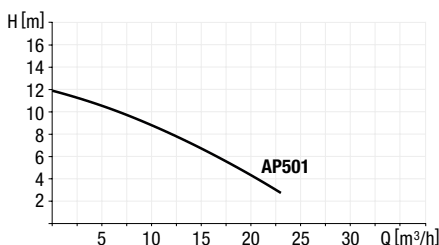
Shaft size in mm	Installation depths D in mm	Art. no.
1300	1400 - 1850	879 711
1800	1900 - 2350	879 721

Duo version with two pumps

Shaft size in mm	Installation depths D in mm	Art. no.
1300	1400 - 1850	878 711
1800	1900 - 2350	878 721



Pumping capacity



Pump type	Voltage	Amperage	Power (P1/P2)	Pumping capacity	Pumping height
AP 501	230 V	6.0 A	1.25 kW / 0.75 kW	6,3 m³/h	12 m

Engineering system chamber Ø 1000 with access opening Ø 600

for combination with engineering system base *Aquapump XL*

EN 13598 Part 2 Z-42.1-527

Made of polyethylene PE-HD

Installation: For underground installation; handles groundwater depths up to 3.000 mm

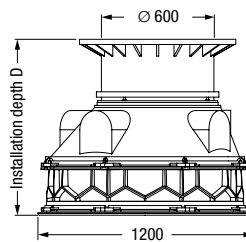
Modular design comprising:

- Chamber rings with access steps fitted
- With telescopic height adjustable upper section
- Round cover made of cast iron
- Includes all sealing gaskets and wedge connectors required for installation

Delivery: As individual elements

Remark: Covers surface water tight

Note: Additional installation depths (on request)



Installation depth D in mm	Class A/B	Class D
	Art. no.	Art. no.
D1: 380 - 629*	874 00 00	874 00 01
D2: 630 - 879*	874 00 06	874 00 07
D3: 880 - 1129*	874 00 12	874 00 13
D4: 1130 - 1379	874 00 18	874 00 19
D5: 1380 - 1629	874 00 24	874 00 25
D6: 1630 - 1879	874 00 30	874 00 31
D7: 1880 - 2129	874 00 36	874 00 37
D8: 2130 - 2379	874 00 42	874 00 43
D9: 2380 - 2629	874 00 48	874 00 49
D10: 2630 - 2879	874 00 54	874 00 55
D11: 2880 - 3129	874 00 60	874 00 61
D12: 3130 - 3379**	874 00 66	874 00 67
D13: 3380 - 3629**	874 00 72	874 00 73
D14: 3630 - 3879**	874 00 78	874 00 79
D15: 3880 - 4129**	874 00 84	874 00 85

* Installation depth D 1 - D 3 only in combination with pumping station Wet installation

** Installation depth D 12 -15 pay attention to maximum installation depth 5.000 mm in combination with engineering system base

Engineering system chamber Ø 1000 with access opening Ø 800

for combination with engineering system base *Aquapump XL*

EN 13598 Part 2 Z-42.1-527

Made of polyethylene PE-HD

Installation: For installation in the concrete slab; handles groundwater depths up to 3.000 mm

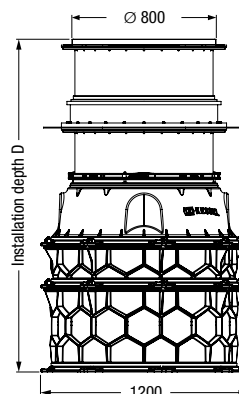
Modular design comprising:

- For waterproof concrete with flange and counter flange
- Chamber rings with access steps fitted
- With telescopic height adjustable upper section
- Square cover made of stainless steel, class A/L 15 or round cover in class K 3
- Includes all sealing gaskets and wedge connectors required for installation

Delivery: As individual elements

Remark: Covers surface water tight

Note: Additional installation depths, upper sections and covers class B/D (on request)



Cover tileable, square

Installation depth D in mm	Art. no.
668 - 917	874 00 03
918 - 1167	874 00 09
1168 - 1417	874 00 15
1418 - 1667	874 00 21
1668 - 1917	874 00 27

Cover not tileable, square, anti-slip

Installation depth D in mm	Art. no.
653 - 902	874 00 05
903 - 1152	874 00 11
1153 - 1402	874 00 17
1403 - 1652	874 00 23
1653 - 1902	874 00 29

Cover not tileable, round

Installation depth D in mm	Art. no.
638 - 887	874 02 22
888 - 1137	874 02 23
1138 - 1387	874 02 24
1388 - 1637	874 02 25
1638 - 1887	874 02 26

Engineering system chamber Ø 1000 with access opening Ø 800

for combination with engineering system base *Aquapump XL*

EN 13598 Part 2 Z-42.1-527

Made of polyethylene PE-HD

Installation: For underground installation; handles groundwater depths up to 3.000 mm

Modular design comprising:

- Chamber rings with access steps fitted
- With telescopic height adjustable upper section
- Covers made of stainless steel
- Includes all sealing gaskets and wedge connectors required for installation

Delivery: As individual elements

Remark: Covers surface water tight

Note: Additional installation depths, upper sections and covers class B / D (on request)



Illustration shows Art. no. 874 01 43



Illustration shows Art. no. 874 00 20

Illustration shows Art. no. 874 01 22

Round cover

Installation depth D in mm Art. no.

Class K 3

D1:	375 - 624	874 01 22
D2:	625 - 874	874 01 23
D3:	875 - 1124	874 01 24
D4:	1125 - 1374	874 01 25
D5:	1375 - 1624	874 01 26
D6:	1625 - 1874	874 01 27
D7:	1875 - 2124	874 01 28
D8:	2125 - 2374	874 01 29
D9:	2375 - 2624	874 01 30
D10:	2625 - 2874	874 01 31
D11:	2875 - 3124	874 01 32
D12:	3125 - 3374**	874 01 33
D13:	3375 - 3624**	874 01 34
D14:	3625 - 3874**	874 01 35
D15:	3875 - 4124**	874 01 36

Square cover

Installation depth D in mm Art. no.

Class B

D1:	620 - 869	874 01 41
D2:	870 - 1119	874 01 42
D3:	1120 - 1369	874 01 43

Class D

D1:	620 - 869	874 01 58
D2:	870 - 1119	874 01 59
D3:	1120 - 1369	874 01 60

** Installation depth D 12 -15 pay attention to maximum installation depth 5.000 mm in combination with engineering system base

Square cover

Installation depth D in mm Art. no.

Class A/L 15, not tileable, anti-slip

D1:	396 - 645	874 00 04
D2:	646 - 895	874 00 10
D3:	896 - 1145	874 00 16
D4:	1146 - 1395	874 00 22
D5:	1396 - 1645	874 00 28
D6:	1646 - 1895	874 00 34
D7:	1896 - 2145	874 00 40
D8:	2146 - 2395	874 00 46
D9:	2396 - 2645	874 00 52
D10:	2646 - 2895	874 00 58
D11:	2896 - 3145	874 00 64
D12:	3146 - 3395**	874 00 70
D13:	3396 - 3645**	874 00 76
D14:	3646 - 3895**	874 00 82
D15:	3896 - 4145**	874 00 88

Class A/L 15, tileable

D1:	411 - 660	874 00 02
D2:	661 - 910	874 00 08
D3:	911 - 1160	874 00 14
D4:	1161 - 1410	874 00 20
D5:	1411 - 1660	874 00 26
D6:	1661 - 1910	874 00 32
D7:	1911 - 2160	874 00 38
D8:	2161 - 2410	874 00 44
D9:	2411 - 2660	874 00 50
D10:	2661 - 2910	874 00 56
D11:	2911 - 3160	874 00 62
D12:	3161 - 3410**	874 00 68
D13:	3411 - 3660**	874 00 74
D14:	3661 - 3910**	874 00 80
D15:	3911 - 4160**	874 00 86

** Installation depth D 12 -15 pay attention to maximum installation depth 5.000 mm in combination with engineering system base

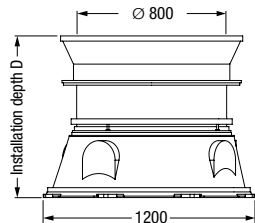


Illustration shows Art. no. 874 01 58

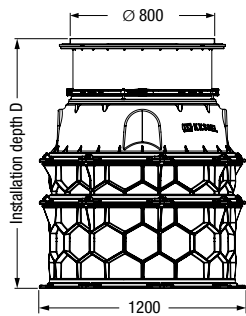


Illustration shows Art. no. 874 00 02

Upper section Ø 800

Made of polymer / stainless steel

Compatibility:

For use as upper section for the engineering system base *Aquapump XL Mono / Duo* for the version with minimum installation depth page 146

Version:

with / without waterproof flange

square, tileable, without waterproof flange



Installation depth D in mm (min./max.)

Covers

Art. no.

65 - 314

Class A/L 15

874 01 75

square, tileable, with waterproof flange



282 - 531

Class A/L 15

874 01 76

square, not tileable, without waterproof flange

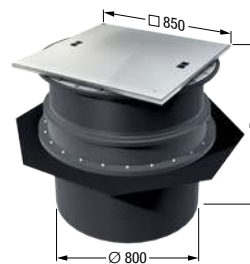


50 - 299

Class A/L 15

874 01 77

square, not tileable, anti-slip, with waterproof flange



267 - 516

Class A/L 15

874 01 78

square, without waterproof flange



274 - 523

Class B

874 01 79

274 - 523

Class D

874 01 80

round, without waterproof flange



65 - 314

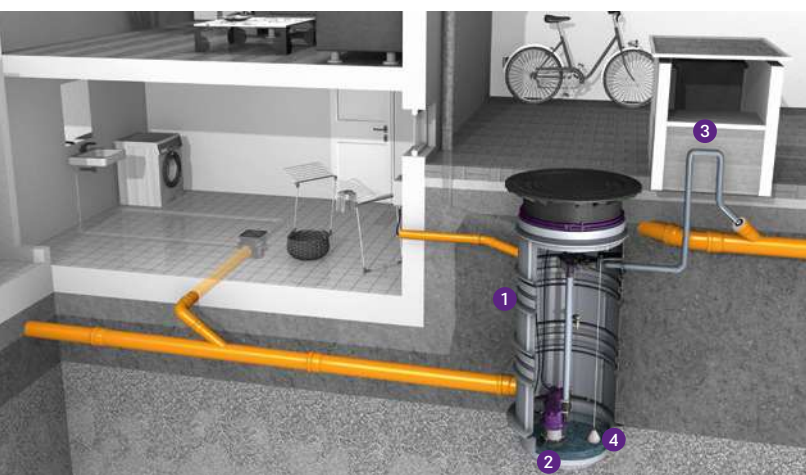
Class K 3

874 01 81

Pumping station *Aquapump Medium*

The compact version for wastewater with or without sewage and rainwater.

The pumping station *Aquapump Medium* is used for the disposal of wastewater with or without sewage below the backwater level. The installation chamber, 600 mm in diameter, contains the pump STZ 1000 for grey and black water and is resistant to groundwater to a depth of 2.500 mm.



1 Pumping station 2 Pump 3 Pressure pipe 4 Pressure sensor



1 Pumping station 2 Pump 3 Pressure pipe

Height-adjustable upper section

The upper section offers vertical adjustability by up to 500 mm. For simple adaptation to the ground level.

Innovative pressure sensor

The pumping station is available with an innovative pressure sensor, which measures the level of wastewater precisely and reliably: as soon as the maximum water level is reached, the pump pumps the water into the sewage system via a pressure pipe.

Maximum safety

The intelligent control unit (for systems with pressure sensor) with integrated self-diagnosis system SDS continually monitors all the electrical components.

Convenient installation

The low weight of the chamber components, straightforward connection technology, high degree of pre-assembly (lower section of the chamber with pressure pipe), fixed connecting pieces for the inlet and pressure pipe and the bore holes with lip seals for the venting and conduit pipe all contribute to fast and easy installation.

Permanent protection

The chamber system is absolutely waterproof and resistant to dirt deposits or aggressive media. In addition, it reliably prevents root penetration. Simple pump maintenance work is particularly easy thanks to integrated guide pipes.

If you want to use the *Aquapump Medium* inside the building:

➤ [Lifting station *Aqualift F* and *S*: page 114/123](#)

Pumping station *Aquapump Medium*

for wastewater with or without sewage



EN 12050 (max 2 WC connections)

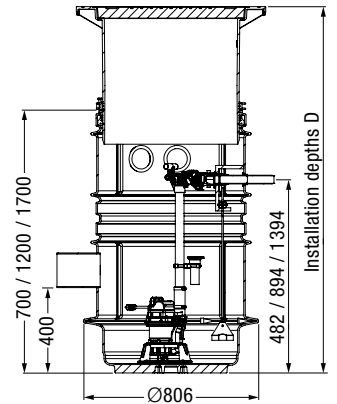
Polyethylene storage chamber Ø 600 for underground installation, resistant to aggressive media. With upper section made of polymer, vertically adjustable, cover class A in polymer load up to 600 kg, class B in cast iron and concrete load up to 12.5 t and cover class D in cast iron load up to 40 t. Groundwater resistant. Inlet Ø 160 mm, connection for pipe gasket for Ø 110 according to EN 1401 and EN 12666-1 - each for ventilation or conduit pipe. Installation: Handles groundwater depths up to 2.500 mm

With **single or twin removable wastewater pump(s)** with macerator for wastewater with or without sewage. Available with float switch or pressure sensor. Pressure pipe Ø 40 mm (version B/D) or Ø 40/63 mm (version A) outside diameter for PVC glue connection, with integrated non-return flap. Power cable length: 10 m (Schuko)

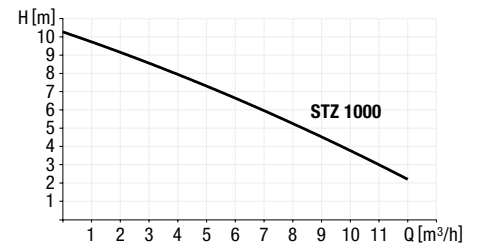
Control unit

Pressure sensor controlled versions with control unit with self-diagnosis system (SDS), battery buffering and logbook function, control unit is splashproof (IP 54).

Note: Consider frost free depth of pressure pipe. For installations without explosion proof requirements.



Pumping capacity



Pump type

	Voltage	Amperage	Power (P1/P2)	RPM	Motor protection	Protection	Pumping capacity	Pumping height
STZ 1000-S3-50%*	230 V	5.2 A	1080 W / 620 W	2.800 min ⁻¹	integrated	IP 68	11.5 m ³ /h	10 m

* Definition of S3-pumps see page 101



Single station with one pump and float switch

Cover class	STZ pump	Installation depths D in mm	Art. no.
A	1000	800 - 1250	827 710A
A	1000	1300 - 1750	827 720A
A	1000	1800 - 2250	827 730A
A	1000	2300 - 2750	827 740A
A	1000	2800 - 3550	827 750A
<hr/>			
B	1000	800 - 1250	827 710B
B	1000	1300 - 1750	827 720B
B	1000	1800 - 2250	827 730B
B	1000	2300 - 2750	827 740B
B	1000	2800 - 3550	827 750B
<hr/>			
D	1000	800 - 1250	827 710D
D	1000	1300 - 1750	827 720D
D	1000	1800 - 2250	827 730D
D	1000	2300 - 2750	827 740D
D	1000	2800 - 3550	827 750D

Single station with one pump with SDS control unit, pressur sensor and optical probe

Cover class	STZ pump	Installation depths D in mm	Art. no.
A	1000	800 - 1250	827 711A
A	1000	1300 - 1750	827 721A
A	1000	1800 - 2250	827 731A
A	1000	2300 - 2750	827 741A
A	1000	2800 - 3550	827 751A
<hr/>			
B	1000	800 - 1250	827 711B
B	1000	1300 - 1750	827 721B
B	1000	1800 - 2250	827 731B
B	1000	2300 - 2750	827 741B
B	1000	2800 - 3550	827 751B
<hr/>			
D	1000	800 - 1250	827 711D
D	1000	1300 - 1750	827 721D
D	1000	1800 - 2250	827 731D
D	1000	2300 - 2750	827 741D
D	1000	2800 - 3550	827 751D

Twin station with two pumps with SDS control unit, pressur sensor and optical probe

Cover class	STZ pump	Installation depths D in mm	Art. no.
A	1000	800 - 1250	826 711A
A	1000	1300 - 1750	826 721A
A	1000	1800 - 2250	826 731A
A	1000	2300 - 2750	826 741A
A	1000	2800 - 3550	826 751A
<hr/>			
B	1000	800 - 1250	826 711B
B	1000	1300 - 1750	826 721B
B	1000	1800 - 2250	826 731B
B	1000	2300 - 2750	826 741B
B	1000	2800 - 3550	826 751B
<hr/>			
D	1000	800 - 1250	826 711D
D	1000	1300 - 1750	826 721D
D	1000	1800 - 2250	826 731D
D	1000	2300 - 2750	826 741D
D	1000	2800 - 3550	826 751D

Pumping station *Aquapump Medium*

for wastewater without sewage and rainwater



CE EN 12050-2

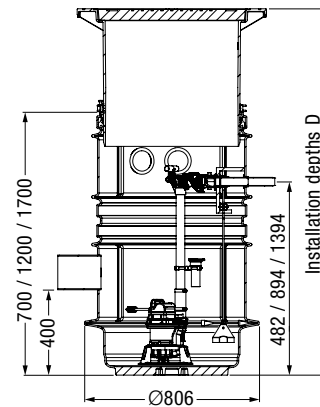
Polyethylene storage chamber Ø 600 for underground installation, resistant to aggressive media. With upper section made of polymer, vertically adjustable, cover class A in polymer load up to 600 kg, class B in cast iron and concrete load up to 12.5 t and cover class D in cast iron load up to 40 t. Groundwater resistant. Inlet Ø 110 mm (*GTF 600*) or Ø 160 mm (*GTF 1200*), connection for pipe gasket for Ø 110 according to EN 1401 and EN 12666-1 - each for ventilation or conduit pipe. Installation: Handles groundwater depths up to 2.500 mm

With **single or twin removable wastewater pump(s)** with multi-vane impeller for wastewater without sewage. Available with float switch or pneumatic level measurement. Pressure pipe Ø 40 mm outside diameter for PVC glue connection, with integrated non-return flap, 10 mm max solid size. Power cable length: 10 m (Schuko)

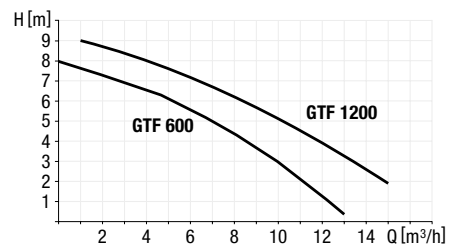
Control unit

Pneumatic versions with control unit with self-diagnosis system (SDS), battery buffering and logbook function, control unit is splashproof (IP 54).

Note: Consider frost free depth of pressure pipe.



Pumping capacity



Pump type	Current type	Voltage	Amperage	Power (P1/P2)	RPM	Motor protection	Protection	Pumping capacity	Pumping height
GTF 600-S1*	Alternating current	230 V	2.9 A	650 W / 400 W	2.800 min ⁻¹	integrated	IP 68	12 m³/h	8 m
GTF 1200-S3-50%*	Alternating current	230 V	4.9 A	1180 W / 720 W	2.800 min ⁻¹	integrated	IP 68	15.5 m³/h	9 m

* Definition of S1 and S3-pumps see page 101



Additional installation depths on request

Single station with one pump and float switch

Cover class	Pump	Installation depths D in mm	Art. no.
A/B	GTF 600	800 - 1250	825 810B
A/B	GTF 600	1300 - 1750	825 820B
A/B	GTF 600	1800 - 2250	825 830B
A/B	GTF 1200	800 - 1250	827 810B
A/B	GTF 1200	1300 - 1750	827 820B
A/B	GTF 1200	1800 - 2250	827 830B
D	GTF 600	800 - 1250	825 810D
D	GTF 600	1300 - 1750	825 820D
D	GTF 600	1800 - 2250	825 830D
D	GTF 1200	800 - 1250	827 810D
D	GTF 1200	1300 - 1750	827 820D
D	GTF 1200	1800 - 2250	827 830D

Single station with one pump with SDS control unit, pneumatic level measurement and optical probe

Cover class	Pump	Installation depths D in mm	Art. no.
A/B	GTF 600	800 - 1250	825 811B
A/B	GTF 600	1300 - 1750	825 821B
A/B	GTF 600	1800 - 2250	825 831B
A/B	GTF 1200	800 - 1250	827 811B
A/B	GTF 1200	1300 - 1750	827 821B
A/B	GTF 1200	1800 - 2250	827 831B
D	GTF 600	800 - 1250	825 811D
D	GTF 600	1300 - 1750	825 821D
D	GTF 600	1800 - 2250	825 831D
D	GTF 1200	800 - 1250	827 811D
D	GTF 1200	1300 - 1750	827 821D
D	GTF 1200	1800 - 2250	827 831D

Twin station with two pumps with SDS control unit, pneumatic level measurement and optical probe

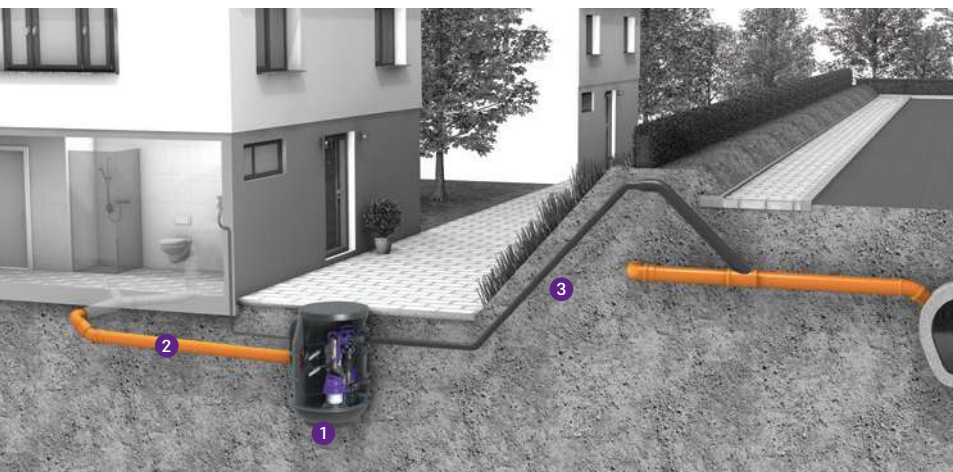
Cover class	Pump	Installation depths D in mm	Art. no.
A/B	GTF 600	800 - 1250	824 811B
A/B	GTF 600	1300 - 1750	824 821B
A/B	GTF 600	1800 - 2250	824 831B
A/B	GTF 1200	800 - 1250	826 811B
A/B	GTF 1200	1300 - 1750	826 821B
A/B	GTF 1200	1800 - 2250	826 831B
D	GTF 600	800 - 1250	824 811D
D	GTF 600	1300 - 1750	824 821D
D	GTF 600	1800 - 2250	824 831D
D	GTF 1200	800 - 1250	826 811D
D	GTF 1200	1300 - 1750	826 821D
D	GTF 1200	1800 - 2250	826 831D

Pumping station *Aquapump Small*

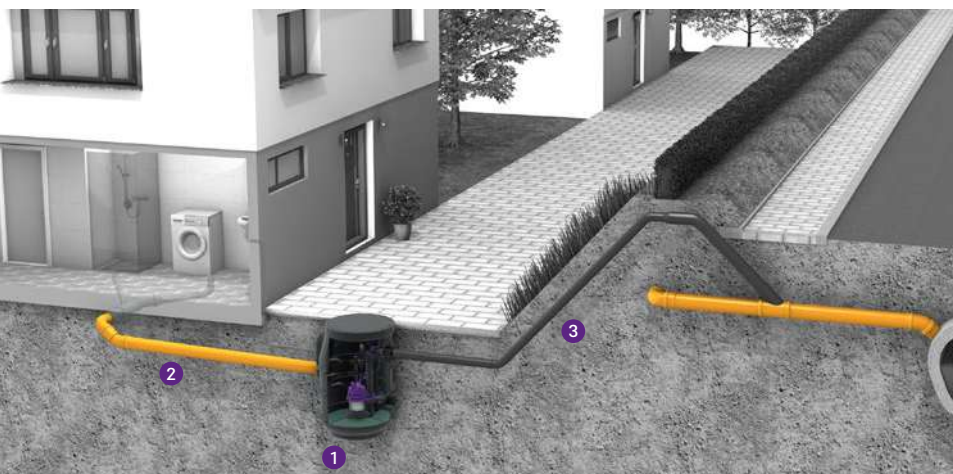
The economic version for wastewater with or without sewage.

The pumping station *Aquapump Small* makes looking for an economic alternative child's play as far as the disposal of wastewater with or without sewage outside buildings is concerned. It provides cutting-edge technology at an unbeatable price, housed in a sturdy installation chamber.

The pumping station *Aquapump Small* is available either as a Mono or Duo system. It is equipped with a float switch and a control unit (Tronic version).



1 Pumping station 2 Inlet connection 3 Pressure pipe



1 Pumping station 2 Inlet connection 3 Pressure pipe

100 % waterproof and odour-tight

Like all KESSEL installation chambers, the tank of the pumping station *Aquapump Small* is absolutely waterproof and odour-tight and is covered by our guarantee, which we have voluntarily extended to 20 years.

Suspended pump(s)

The pumping station has either one or two freely suspended pumps of the type STF 1300. Noise levels during operation are reduced by decoupling from the tank body.

Tool-free maintenance

The pump can be removed and serviced very easily thanks to the quick-release closures.

Variable upper section

The optional upper section is inclinable and height adjustable from 140 to 440 mm.

If you want to use the *Aquapump Small* inside a building:

➤ Lifting station *Aqualift F Basic*: page 117

Pumping station *Aquapump Small* for wastewater with or without sewage



CE EN 12050-1

Pump volume:

25 liters (Mono) / 60 liters (Tronic / Duo)

Polyethylene storage chamber for underground installation (installation depth max. 440 mm), drilling surfaces on three sides for inlet \varnothing 110/160 mm, pipe gasket and ventilation. With polymer cover, screwed, load class 300 kg.

Float switch controlled **single or twin removable wastewater pump(s)** with multi-vane impeller for wastewater with or without sewage (open channel passage 40 mm). Pump is rated submersible (IP 68). Pressure pipe connection \varnothing 50/63 mm with integrated non-return flap.

Control unit

Tronic versions with Basic control unit with self-diagnosis system (SDS), battery buffering, control unit is splash proof (IP 54).

Note:

- A ventilation pipe must be provided for on site.
- Consider frost free depth of pressure pipe.
- For installations without explosion proof requirements.

Accessories: page 167 – 170



Illustration shows Mono version Art. no. 829 710



Illustration shows Duo version Art. no. 828 711

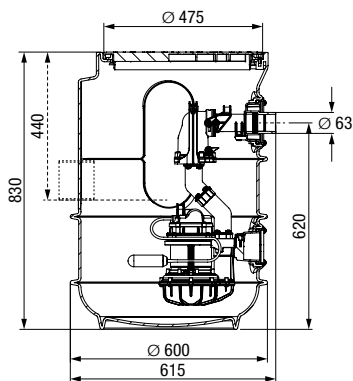


Illustration shows Mono version Art. no. 829 710

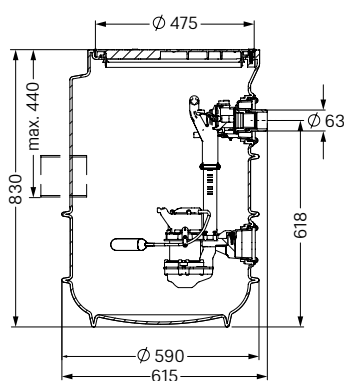


Illustration shows Mono version Art. no. 829 810

Pump type	Voltage	Amperage	Power (P1/P2)	RPM	Pumping capacity	Pumping height
STF 1300-S3-50%*	230 V ~ 50 Hz	6.0 A	1.3 kW / 0.8 kW	2.650 min ⁻¹	21 m ³ /h	max. 10 m
GTF 600-S1*	230 V ~ 50 Hz	2.9 A	0.65 kW / 0.4 kW	2.750 min ⁻¹	12 m ³ /h	max. 8 m
GTF 1250-S3*	230 V ~ 50 Hz	5.4 A	1.3 kW / 0.8 kW	2.700 min ⁻¹	20 m ³ /h	max. 11 m

* Definition of S1 and S3-pumps see page 101



With or without sewage

Mono version with one pump

STF pump	Level measurement	Art. no.
----------	-------------------	----------

Without control unit

1300-S3	float switch	829 710
---------	--------------	---------

With control unit

1300-S3	float switch	829 711
---------	--------------	---------

Duo version with two pumps

STF pump	Level measurement	Art. no.
----------	-------------------	----------

With control unit

1300-S3	float switch	828 711
---------	--------------	---------

Without sewage and rainwater

Mono version with one pump

GTF pump	Level measurement	Art. no.
----------	-------------------	----------

Without control unit

600-S1	float switch	829 810
1250-S3	float switch	829 850

With control unit

600-S1	float switch	829 811
1250-S3	float switch	829 851

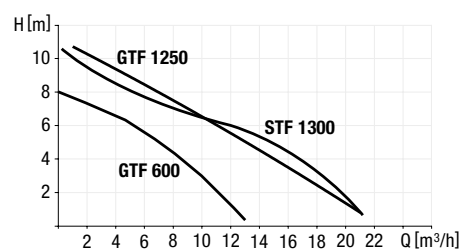
Duo version with two pumps

GTF pump	Level measurement	Art. no.
----------	-------------------	----------

With control unit

600-S1	float switch	828 811
1250-S3	float switch	828 851

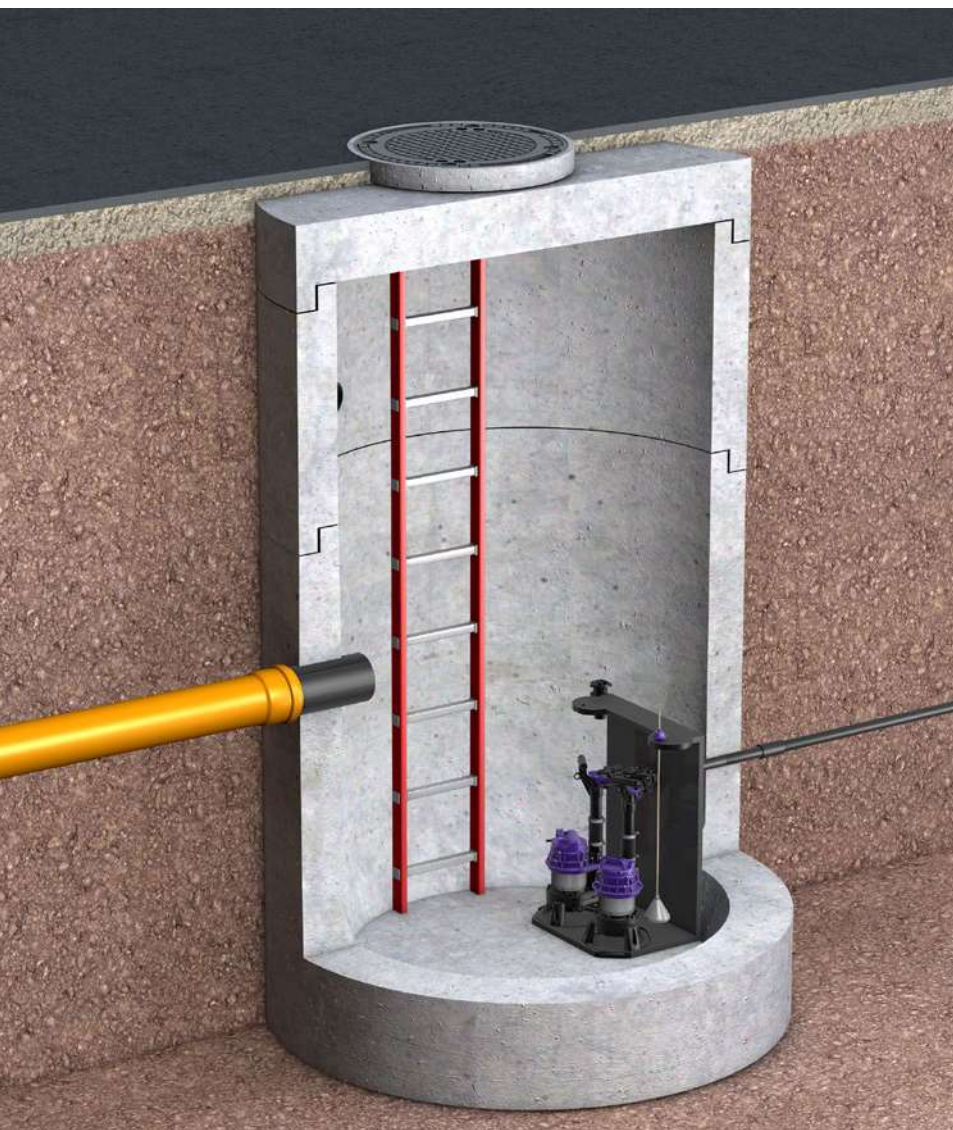
Pumping capacity



Pumping station *Aquapump Retrofit*

Submersible pumps for collecting tanks.

Permanently dry: if a permanent solution is required, existing collecting tanks provided by the customer can be retrofitted with a pumping station for stationary use.



Pumps

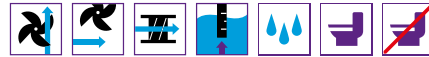
The pumping station has either one or two (mostly freely suspended) pumps of the types STZ, GTF and GTK from 600 to 4000 W.

Tool-free maintenance

The pump can be removed and serviced very easily thanks to the quick-release closures.

Pumping station *Aquapump Retrofit*

Wet installation, for installation in on-site collection tank



Version contains:

- Pump base, backwater flaps and gate closure valves
- Hydrostatic level sensor
- KESSEL Comfort 400 V control unit
- PE pressure pipe with Ø 63 mm (DN 50) and Ø 90 mm (DN 80)



Pumping capacity: max. ... m³/h

Voltage: 400 V ~ 50 Hz

Cable length: 10 m

Note: *Aquapump Retrofit* should be installed in a chamber with a minimum diameter of 1.000 mm

Pump STZ

- For wastewater with or without sewage
- Pump(s) with high performance macerating system for operational reliability
- Mono or Duo version
- ATEX Certification

Pump GTF

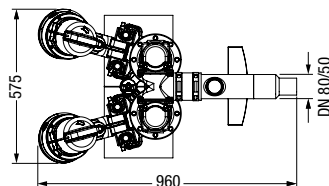
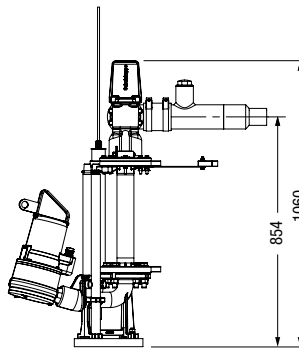
- For wastewater with or without sewage (check your local ATEX regulations)
- With multi-vane impeller
- Mono or Duo version

Pump GTK

- For wastewater with or without sewage (check your local ATEX regulations)
- Single-channel impeller pumps - high performance, ultra-low energy usage
- Duo version

On request:

- Vertical pressure outlet
- Variable pressure pipe height / lengths
- Custom pressure pipe sizes



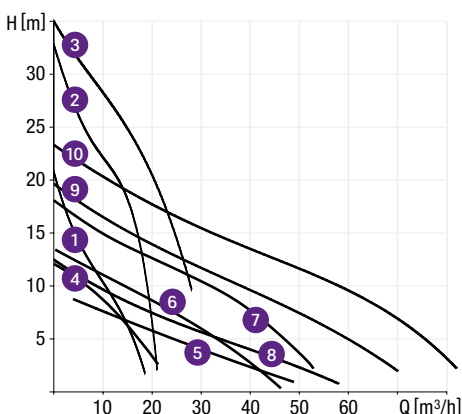
Mono version with one pump

Pump	Art. no.
STZ	
STZ 1300	STZ1300-M*
STZ 2500	STZ2500-M*
STZ 3700	STZ3700-M*
GTF	
GTF 1400	GTF1400-M*
GTF 1600	GTF1600-M*
GTF 2600	GTF2600-M*
GTF 4000	GTF4000-M*
GTK	
GTK 1300	GTK1300-M*
GTK 2600	GTK2600-M*
GTK 3700	GTK3700-M*

Duo version with two pumps

Pump	Art. no.
STZ	
STZ 1300-D	874 40 10
STZ 2500-D	874 40 12
STZ 3700-D	874 40 14
GTF	
GTF 1400-D	874 40 20
GTF 1600-D	874 40 22
GTF 2600-D	874 40 24
GTF 4000-D	874 40 26
GTK	
GTK 1300-D	874 40 30
GTK 2600-D	874 40 32
GTK 3700-D	874 40 34

Pumping capacity

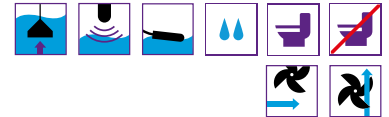


Pump type	Voltage	Amperage	Input power (P1)	Power (P2)	Pumping capacity	Pumping height
1 STZ 1300-S1*	400 V	2.5 A	1.3 kW	0.9 kW	20 m ³ /h	21 m
2 STZ 2500-S1*	400 V	4.4 A	2.5 kW	1.9 kW	21 m ³ /h	33 m
3 STZ 3700-S1*	400 V	6.4 A	3.7 kW	3.1 kW	28 m ³ /h	35 m
4 GTF 1400-S1*	230 V	6.5 A	1.5 kW	1.1 kW	31 m ³ /h	10.5 m
5 GTF 1600-S1*	400 V	2.9 A	1.6 kW	1.2 kW	49 m ³ /h	9.3 m
6 GTF 2600-S1*	400 V	4.5 A	2.6 kW	2.1 kW	46 m ³ /h	13.6 m
7 GTF 4000-S1*	400 V	6.6 A	4.0 kW	3.4 kW	53 m ³ /h	18 m
8 GTK 1300-S1*	400 V	2.5 A	1.3 kW	1.0 kW	57 m ³ /h	12.4 m
9 GTK 2600-S1*	400 V	4.9 A	2.6 kW	2.1 kW	71 m ³ /h	19.6 m
10 GTK 3700-S1*	400 V	6.5 A	3.7 kW	3.1 kW	82 m ³ /h	23.5 m

*Definition of S1-pump see page 101

Pumping station *Aquapump Retrofit*

for rainwater or non-WC wastewater, for installation in on-site collection tank



Product: KESSEL EN 12050-2

Version contains:

- Two removable pumps
- *Aqualift Comfort* 230 V duo control unit
- Pressure sensor level control for conductive and non conductive liquids
- Pressure piping with non-return flap and closure lev
- Pressure connection: Ø 40 mm pressure pipe for PVC glue connection
- PE-HD fixing mount for installation and mounting of pumping system
- With *Comfort* control unit for wall mounting in dry, frost protected rooms, splash-proof, fully automate pump level control with optical and audible alarm system, detailed operation and warning status in multiple line digital display. Optional forwarding of alarm and fault message via GSM interface



Cable length: 10 m

Pump *GTF 1200* and *GTF 1250*

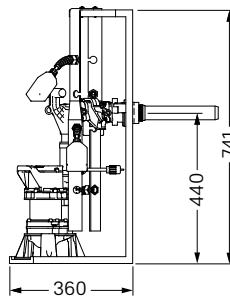
Fuses: 3 x 16 A
 Protection: IP 68 (pump), 20mWS / 48h
 Operating mode: S1



Pump *GTF 1000*

Motor protection: integrated
 Protection: IP 68 (pumps), IP 54 (control unit)
 Operating mode: S1

Illustration shows Pump *GTF 600* with pressure sensor level control



Pump *GTF 600*

Motor protection: integrated
 Protection: IP 68 (pumps), IP 54 (control unit)
 Operating mode: S1

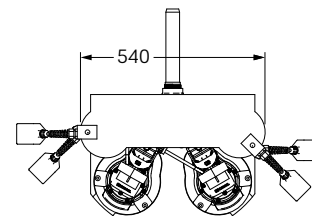


Illustration shows Pump *GTF 600* with float switch

Duo version with two pumps

GTF pump	Art. no.
with submersible pressure switch	
GTF 600	874 40 00*
GTF 1000	874 40 02*
GTF 1200	874 40 04*
GTF 1250	874 40 06*
With float switch	
GTF 600	874 40 01*
GTF 1000	874 40 03*
GTF 1200	874 40 05*
GTF 1250	874 40 07*

*Custom made product (delivery time on request)

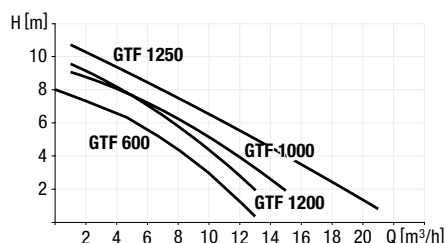
Mono Tronic version with one pump

STZ pump	Art. no.
With pressure sensor	
1000	AQUALI1000F_T
With float switch	
1000	AQUALI1000F_TS

Duo Tronic version with two pumps

STZ pump	Art. no.
With pressure sensor	
1000	AQUALI1000F_D
With float switch	
1000	AQUALI1000F_DS

Pumping capacity



Pump type

Pump type	Voltage	Amperage	Power (P1/P2)	RPM	Pumping capacity	Pumping height
GTF 600-S1*	230 V ~ 50 Hz	2.9 A	0.65 kW / 0.4 kW	2.750 min ⁻¹	12 m ³ /h	8 m
GTF 1000-S1*	230 V ~ 50 Hz	5.6 A	1.3 kW / 0.75 kW	2.800 min ⁻¹	13.5 m ³ /h	10 m
GTF 1200-S1*	230 V ~ 50 Hz	6.2 A	1.4 kW / 0.84 kW	2.650 min ⁻¹	15.5 m ³ /h	9 m
GTF 1250-S1*	230 V ~ 50 Hz	5.4 A	1.3 kW / 0.8 kW	2.700 min ⁻¹	20 m ³ /h	11 m

* Definition of S1-pump see page 101

Accessories

Upper section

Art. no.

Upper section

Compatibility: For pumping station *Aquapump Basic*
Extension: From 140 - 440 mm, height adjustable;
 two can also be installed on top of each other



829 100

Closure valves

Art. no.

Closure valve

Compatibility: For pumping station *Aquapump Basic Mono* version



829 200

Closure valve

Compatibility: For pumping station *Aquapump Basic Duo* version



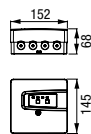
829 250

Alarm unit

Art. no.

with electrode probe

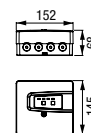
Compatibility: For pumping station *Aquapump Basic*, engineering system base *Aquapump XL*
Function: High water / flood alarm system; for conductive liquids
Inclusive: Visual and audible alarm warning, battery back up, with Logbook, connection for remote alarm speaks (Art. no. 20 162) or upgradable with potential free contact.
Voltage: 230 V ~ 50 Hz (IP 54)
Plug: 2 pin grounded
Cable length: 5 m (extendable up to 30 m)



20 222

with optical probe

Compatibility: For pumping station *Aquapump Basic*, engineering system base *Aquapump XL*
Function: High water / flood alarm system; for conductive / non-conductive liquids
Inclusive: Visual and audible alarm warning, battery back up, with Logbook, connection for remote alarm speaks (Art. no. 20 162) or upgradable with potential free contact.
Voltage: 230 V ~ 50 Hz (IP 54)
Plug: 2 pin grounded
Cable length: 5 m (extendable up to 30 m)



20 223

Cable length: 10 m (extendable up to 30 m)

20 224

Potential-free contact

Compatibility:
 For warning devices Art. no. 20 222 and 20 223



80 074

Accessories

Extension section


			Art. no.
500 mm	Compatibility: Engineering system base backwater chamber Inclusive: 2 access steps, installed Note: Without gasket and connecting wedges		680 371
250 mm	Compatibility: Engineering system base backwater chamber Inclusive: 1 access step, installed Note: Without gasket and connecting wedges		680 370

Gasket / Connection and attachment set



			Voltage	Art. no.
Cable piping gasket set	Compatibility: Control unit 230 V and 400 V		in the building 230 V	85 401
			in the building 400 V	85 402
			in the chamber 230 V	85 403
			in the chamber 400 V	85 404
Set of connecting wedges	Compatibility: Art. no. 680 371 and 680 370 Set-content: 10 pieces			680 373
Profiled gasket	Compatibility: Art. no. 680 371 and 680 370			680 125
Cable attachment set	Compatibility: Engineering systems base Set-content: 3 pieces of clamps			28 076

Cable extensions

for extension from 20 m or 30 m (cable length delivered: 10 m, for 230 V)

	Mono version Pumping station <i>Aquapump XL</i> dry installation, pumping station <i>Aquapump Medium</i> Ø 600/1000	Duo version Pumping station <i>Aquapump XL</i> dry installation, pumping station <i>Aquapump Medium</i> Ø 600/1000		Art. no.
Cable extension for probe (10 m)	Extension to 20 m: 1×80 889 Extension to 30 m: 2×80 889	Extension to 20 m: 1×80 889 Extension to 30 m: 2×80 889		80 889
Cable extension for pump (10 m)	Extension to 20 m: 1×80 891 Extension to 30 m: 2×80 891	Extension to 20 m: 2×80 891 Extension to 30 m: 4×80 891		80 891

Level sensor

			Art. no.
Level sensor with immersion pipe 288 mm	Compatibility: For <i>Aquapump XL</i> , for wastewater with or without sewage Cable length: 10 m		681 042
	Cable length: 30 m		681 043
Level sensor	Compatibility: For <i>Aquapump XL</i> , for wastewater without sewage Cable length: 10 m		681 044
	Cable length: 30 m		681 045

Accessories

Safety		Art. no.	
TeleControl telemetric system	Compatibility: For connection to KESSEL Comfort control units 230 Volt and 400 Volt Function: Relaying of full text messages to up to three mobile phones Inclusive: With internal antenna (without SIM card)	28 792	
Equipotential bonding rail	Compatibility: For ATEX pumping stations Mono	28 088	
	Compatibility: For ATEX pumping stations Duo	28 089	
Antenna booster with magnetic base	Compatibility: For TeleControl telemetric system to improve the reception Cable length: 2.5 m	28 793	
Extension cable	Compatibility: For antenna booster Cable length: 2 m	28 794	
Warning beacon	Function: For the additional visual display of faults, for installation on the outdoor control cabinet, with switching unit for connection to the control unit	97 715	
Installation set Thermostat / Hygrostat	Function: As an additional module for installation in the outdoor kiosk to reduce condensation	97 713	
Air compressor set	Function: For use in combination with lifting station and pumping stations with pressure control: prevents soiling, avoids the formation of condensate in the pressure hose, makes operation of systems possible with pressure hose lengths > 10 m - 30 m Inclusive: T-piece connection, 20 m pressure hose	28 048	
PE-pressure hose extension (per meter)	Compatibility: For Art. no. 28 048	680 071	
Optical probe		Art. no.	
Optical probe	Inclusive: 3 adaptors Cable length: 5 m (Optional cable extension)	80 888	
Pump removal chain		Length in mm Art. no.	
to remove pumps (made of stainless steel)	Compatibility: For pumping stations with wet installation Inclusive: Screw hooks, shackles	2	680 528
		3	680 529
		4	680 530
		5	680 531
Junction box		Art. no.	
Junction box	Compatibility: For extension of level probe	28 799	

Accessories

Outdoor control cabinet

for installation of control units, modems, heating element, warning beacon outside of buildings

	Height over ground level: 870 mm		Height over all in mm	Width / depth in mm	Art. no.
for control unit, heating, warning beacon			1740	460/320	97 716
for heating and pressure pipe			1740	590/320	97 714
for control unit, modem, heating, warning beacon			1740	785/320	97 723
for control unit, modem, heating, warning beacon and pressure pipe			1790	1115/320	97 724

Note: • factory cut holes available on request: info@kessel.com
 • if the Outdoor Control Cabinet is exposed to direct sunlight, it is recommended that an optional cooling system is installed

Peltier cooler set

Art. no.

Peltier cooler set	Compatibility: For horizontal mounting on KESSEL outdoor control cabinets Inclusive: Mains adapter, thermostat	681 148
---------------------------	---	----------------

Clamp connector

Outer diameter Ø (mm) Art. no.

Clamp connector	Compatibility: For on site connection of pressure pipes		DN 32 - 32	28 094
			DN 32 - 50	28 095
			DN 80 - 80	28 090
			DN 50 - 50	28 091
			DN 50 - 80	28 092

Click adapter

Outer diameter Ø (mm) Art. no.

Adapter set	Compatibility: <i>Aquapump Small</i> Function: Optional set facilitating external pipe connection Contain: Adapter with internal thread 2" and a fitting with external thread 2" and quick-connection ending for easy installation		28 097
--------------------	---	--	---------------

Outdoor control cabinet

preassembled version; with factory-mounted system components; outdoor pillar cabinet

Material: Glass-fibre reinforced polyester

Version includes:

- standard cabinet with profiled surface
- open floor
- three-point locking with swivel handle
- with Euro lock cylinder
- door opening angle 180°

Protection rating: IP44

Colour: RAL 7035

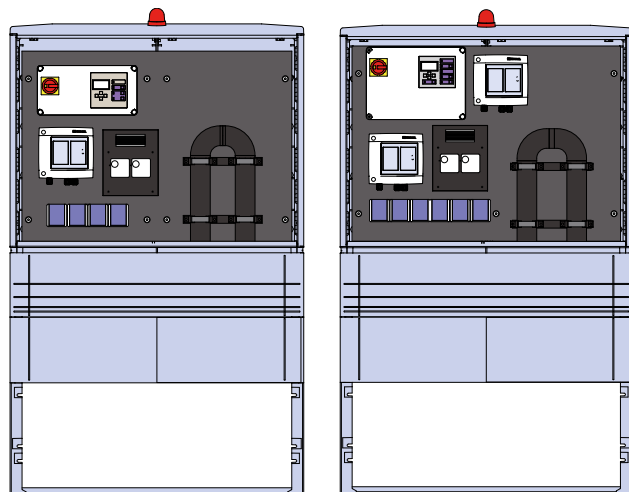
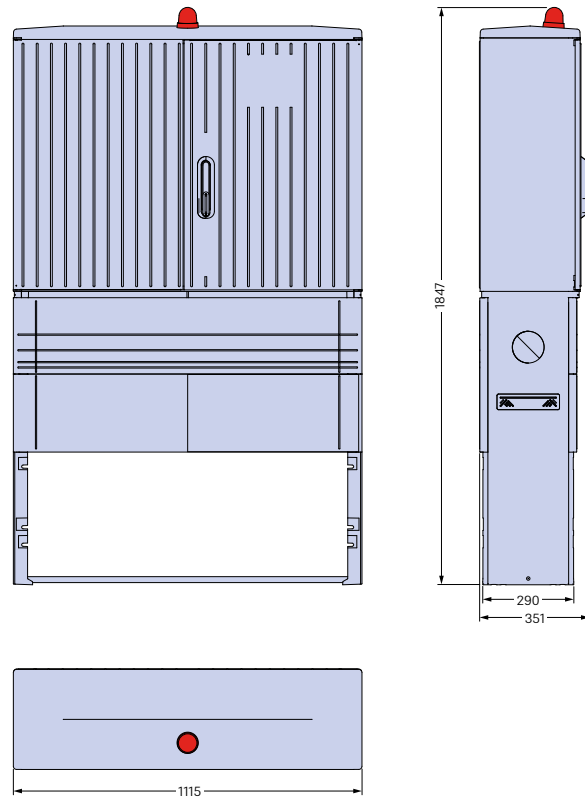


Illustration shows Example for Aqualift S/F

Illustration shows Example for Ecolift XL

3.3 Submersible pumps, conversion & control units

For mobile use

Submersible pumps

Aquadive GTK, KTP, GTF and STZ

Pump - whenever and wherever you want.

Use of a permanently installed pump is not always possible or meaningful. Submersible pumps offer flexible solutions for private and commercial applications.



Powerful

Submersible motor pumps are suitable for pumping larger quantities of clear water, rainwater and wastewater in mobile use. These can be used to pump out chambers, basements or swimming pools.

Flexible use

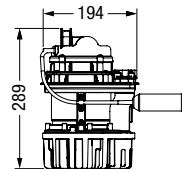
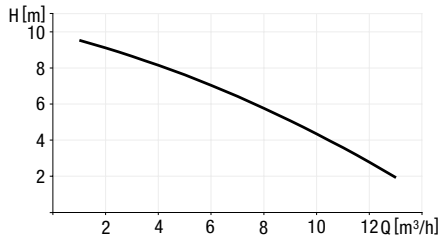
Our absolutely corrosion-free submersible pump has a pressure pipe connection R1 1/4, either vertical or lateral. The vertical connection is used for deep and narrow containers, while the lateral outlet can be used in wider chambers / pits.

Submersible pump *Aquadive GTF 1000 / GTF 1000 resistant* for wastewater without sewage



With/without float switch, without macerator,
connection to pressure pipe 1 1/4 inch side / vertical
Cable length: 10 m

Pumping capacity



GTF 1000

Pressure connection	Art. no.
Without float switch	
1 1/4 inch	28 760
With float switch	
1 1/4 inch	28 860

GTF 1000 resistant

Pressure connection	Art. no.
Without float switch	
1 1/4 inch	28 760C
With float switch	
1 1/4 inch	28 860C

Pump type	Current type	Voltage	Current	Power (P1/P2)	Power consumption	RPM	Submersible depth	Motor protection	Particle size	Pumping capacity	Pumping height
GTF 1000-S3-30%*	Alternating current	230 V	5.6 A	1270 W / 730 W	1000 W	2.800 min ⁻¹	max. 10 m	integrated	max. 10 mm	14.5 m³/h	10 m
GTF 1000-S3-30% resistant*	Alternating current	230 V	5.6 A	1270 W / 730 W	1000 W	2.800 min ⁻¹	max. 10 m	integrated	max. 10 mm	14.5 m³/h	10 m

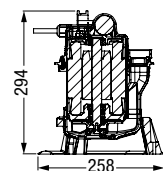
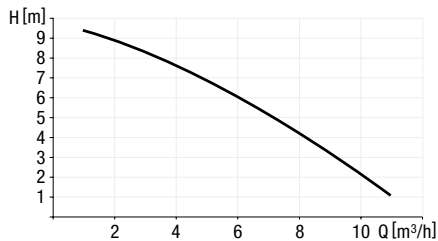
* Definition of S3-pumps see page 101

Submersible pump *Aquadive STZ 1000* for wastewater containing raw sewage



With / without float switch, with macerator,
connection to pressure pipe 1 1/4 inch side / vertical
Cable length: 10 m

Pumping capacity



Pressure connection	Art. no.
Without float switch	
1 1/4 inch	28 779
With float switch	
1 1/4 inch	28 778

Pump type	Current type	Voltage	Current	Power (P1/P2)	Power consumption	RPM	Submersible depth	Motor protection	Pumping capacity	Pumping height
STZ 1000-S3-30%*	Alternating current	230 V	4.9 A	1080 W / 620 W	1000 W	2.800 min ⁻¹	max. 10 m	integrated	12 m³/h	10 m

* Definition of S3-pumps see page 101

Submersible pump *Aquadive GTF 500 / GTF 500 resistant* for wastewater without sewage

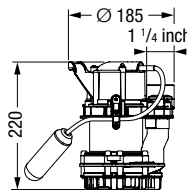


With / without float switch, with integrated low-intake, removable suction basket and convenient transport handle, connection to pressure pipe 1 1/4 inch vertical

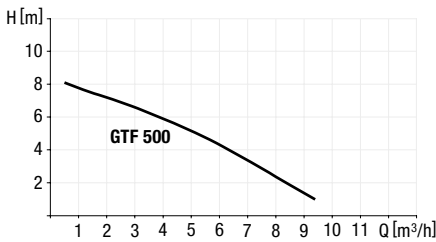
Cable length: 10 m

GTF 500 resistant:

Resistant against aggressive wastewater containing salts, condensates and effluent from water softening systems.



Pumping capacity



Pump type

Pump type	Current type	Voltage	Current	Power (P1/P2)	RPM	Motor protection	Plug	Pumping capacity	Pumping height
GTF 500-S1*	Alternating current	230 V	2.7 A	600 W / 360 W	2.800 min ⁻¹	integrated	coded plug	10 m ³ /h	8 m
GTF 500-S1 resistant*	Alternating current	230 V	2.7 A	600 W / 360 W	2.800 min ⁻¹	integrated	Schuko	10 m ³ /h	8 m

* Definition of S1-pumps see page 101

GTF 500

Pressure connection	Art. no.
Without float switch	
1 1/4 inch	280 710
With float switch	
1 1/4 inch	280 810

GTF 500 resistant

Pressure connection	Art. no.
Without float switch	
1 1/4 inch	280 750
With float switch	
1 1/4 inch	280 850

Submersible pump *Aquadive KTP 300 / KTP 300 resistant* for wastewater without sewage

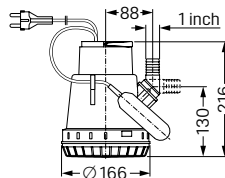
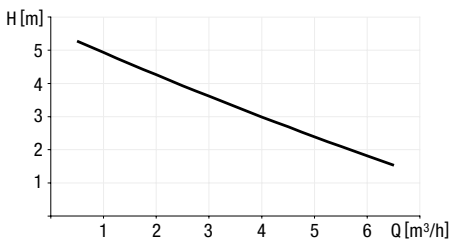


With/without float switch, with backwater flap, pivotable connection to pressure pipe 1 inch side / vertical

Cable length: 10 m

Note: Removable input basket - can pump down to a level of 8 mm.

Pumping capacity



Pump type

Pump type	Current type	Voltage	Current	Power (P1/P2)	RPM	Submersible depth	Motor protection	Plug	Pumping capacity	Pumping height
KTP 300-S1*	Alternating current	230 V	1.6 A	360 W / 210 W	2.800 min ⁻¹	max. 10 m	integrated	Schuko	8 m ³ /h	6 m
KTP 300-S1 resistant*	Alternating current	230 V	1.6 A	360 W / 210 W	2.800 min ⁻¹	max. 10 m	integrated	Schuko	8 m ³ /h	6 m

* Definition of S1-pumps see page 101

KTP 300

Pressure connection	Art. no.
Without float switch	
1 inch	28 740
With float switch	
1 inch	28 840

KTP 300 resistant

Pressure connection	Art. no.
Without float switch	
1 inch	28 740C
With float switch	
1 inch	28 840C

Warning and control units

User-friendly solutions for all types of control tasks.

You can only get the best performance out of your device with the right settings. Whether 230 V or 400 V, all parameters can be set easily with a suitable *Comfort* control unit. Our control units are delivered plug-in ready and can be connected without the help of an electrician (230 V units). The menu guidance is also very user-friendly – with a multi-line display in six languages. A remote signal generator or even a GSM modem, which sends messages in full text, can be connected for relaying messages.

Maximum reliability

The intelligent control unit with integrated self-diagnosis system SDS and battery buffering continually monitors all electrical components and keeps an electronic operating log, which can be read out using separate software.

Adjustable function parameters

The control units *230 V Comfort* and *400 V Comfort* offer convenient menu guidance on the display. This allows the function-relevant parameters and the operating hour counter to be set very easily.

Countless customising possibilities

KESSEL offers a variety of probes for different requirements – also for products from other manufacturers – such as an ATEX version for potentially explosive areas. It also offers connection options for float switches, building management systems and conductance probes (only 230 V), submersible pressure switches, optical probes (only 230 V), level probes (on a terminal strip) or GSM interfaces for relaying full-text messages.

230 V Comfort control unit

Mono-/Duo control unit with hydrostatic level sensor

Mono-/Duo control unit

Extremely versatile sensor system for measuring the level of wastewater with and without sewage. Including level probe for pneumatic level measurement and failure detection of the level probe via the control unit. The 10 m level probe cable can be extended to 30 m.

Note:

For greasy or hot wastewater, the use of a small compressor is **not** necessary.

Versions:

- with hydrostatic level sensor / without extra alarm probe
- with hydrostatic level sensor / float switch: with float switch for alarm level measurement, 10 m float switch cable (can be extended to 30 m)



Illustration shows Art. no. 28 731 P



Illustration shows Art. no. 28 731 PS

For Mono versions

Art. no.

With hydrostatic level sensor / without extra alarm probe

28 731 P

With hydrostatic level sensor / float switch

28 731 PS

For Duo versions

Art. no.

With hydrostatic level sensor / without extra alarm probe

28 746 P

With hydrostatic level sensor / float switch

28 746 PS

230 V Comfort control unit

Mono-/Duo control unit with pressure sensor

Mono-/Duo control unit

Extremely versatile sensor system for measuring the level of wastewater with and without sewage. Including plunger for pneumatic level measurement. The 10 m pressure hose can be extended to 15 m (up to 30 m on request).

Note:

For greasy or hot wastewater use only in connection with the air compressor set (Article 28 048).

Versions:

- with pressure sensor / without extra alarm probe
- with pressure sensor/conductance probe: with separate conductance probe for alarm level measurement, 5 m cable (cannot be extended)
- with pressure sensor / float switch: with separate float switch for alarm level measurement, 10 m float switch cable (can be extended to 30 m)
- with pressure sensor / optical probe: with separate optical probe for alarm level measurement and failure detection of the optical probe via the control unit, 5 m cable for optical probe (can be extended to 30 m)



Illustration shows Art. no. 28 731 D



Illustration shows Art. no. 28 731 DL



Illustration shows Art. no. 28 731 DS



Illustration shows Art. no. 28 731 DO

For Mono versions

Art. no.

With pressure sensor* / without extra alarm probe

28 731 D

With pressure sensor* / conductance probe

28 731 DL

With pressure sensor* / float switch

28 731 DS

With pressure sensor* / optical probe

28 731 DO

For Duo versions

Art. no.

With pressure sensor* / without extra alarm probe

28 746 D

With pressure sensor* / conductance probe

28 746 DL

With pressure sensor* / float switch

28 746 DS

With pressure sensor* / optical probe

28 746 DO

*air compressor available for pressure switches with over 10 m cable

230 V Comfort control unit

Mono-/Duo control unit with float switch

Mono-/Duo control unit

Sensor system for level measurement for wastewater without sewage. With float switches to measure ON 1, ON 2 (only 28 746-S) and OFF levels. The 10 m float switch cable can be extended to 30 m.

Versions:

- with float switch / without extra alarm probe
- with float switch / float switch: with separate float switch for alarm level measurement



For Mono versions

Art. no.

With float switch / without extra alarm probe

28 731 S

With float switch / float switch

28 731 SX

For Duo versions

Art. no.

With float switch / without extra alarm probe

28 746 S

With float switch / float switch

28 746 SX

230 V Comfort control unit

Mono-/Duo control unit with conductance probe

Mono-/Duo control unit

Sensor system for level measurement for wastewater without sewage. Including alarm level measurement. Not suitable for rainwater or non-diluted condensate. Including conductance probes for the measuring of ON 1, ON 2 (28 746-LLF / 28746-LLV only), OFF and ALARM level. Switching points cannot be adjusted freely. 5 m cable for conductance probe.

Versions:

- with conductance probe/conductance probe: Level ON / OFF fixed, alarm level can be adjusted
- with conductance probe/conductance probe: ON 1 fixed / ON 2 variable / ALARM with fixed distance to ON 2
- with conductance probe/conductance probe: ON 1 variable / ON 2 fixed / ALARM with fixed distance to ON 2



Illustration shows
Art. no. 28 746 LLF

Illustration shows
Art. no. 28 731 LL

For Mono versions

Art. no.

With conductance probe / conductance probe

28 731 LL

For Duo versions

Art. no.

With conductance probe / conductance probe,
ON 1 fixed/ON 2 variable

28 746 LLF

With conductance probe / conductance probe,
ON 1 variable / ON 2 fixed

28 746 LLV

400 V Comfort control unit

Mono-/Duo control units

Versions:

- Mono-/Duo control unit



Illustration shows
Art. no. 28 755

For Mono versions

Art. no. max. switching current (A) from - to

Without ATEX version

28 755	2.5 - 4.0
28 756	4.0 - 6.3
28 781	6.3 - 10.0

With ATEX version

28 759	2.5 - 4.0
28 761	4.0 - 6.3

For Duo versions

Art. no. max. switching current (A) from - to

Without ATEX version

28 757	2×2.5 - 4.0
28 758	2×4.0 - 6.3
28 783	2×6.3 - 10.0

With ATEX version

28 762	2×2.5 - 4.0
28 763	2×4.0 - 6.3

Accessories





Hydrostatic level sensor

Art. no.

Level sensor	Compatibility: For <i>Aqualift F</i> lifting stations and pump stations; for use with Comfort 230 V and 400 V control units Cable length: 10 m		28 082
--------------	---	---	--------

Level sensor

Art. no.

Level sensor with immersion pipe 433 mm	Compatibility: For lifting stations <i>Aqualift F XL</i> Cable length: 10 m <hr/> Cable length: 30 m		681 040 <hr/> 681 041
Level sensor with immersion pipe 288 mm	Compatibility: For lifting stations <i>Aqualift F Duo</i> and pump stations <i>Aquapump XL</i> Cable length: 10 m <hr/> Cable length: 30 m		681 042 <hr/> 681 043
Level sensor with immersion pipe 181 mm	Compatibility: For lifting stations <i>Aqualift F Mono</i> Cable length: 10 m <hr/> Cable length: 30 m		681 046 <hr/> 681 047
Level sensor	Compatibility: For pump stations <i>Aquapump XL</i> Cable length: 10 m <hr/> Cable length: 30 m		681 044 <hr/> 681 045

Float switch

Art. no.

Float switch	Compatibility: For use with Comfort 230 V and 400 V control units Cable length: 10 m <hr/> Compatibility: For use with Comfort 230 V and 400 V control units Cable length: 20 m		185-043 <hr/> 185-045
--------------	--	---	--------------------------

Safety

Art. no.


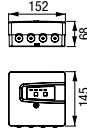

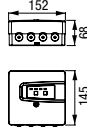
<i>TeleControl</i> telemetric system	Compatibility: For connection to KESSEL Comfort control units 230 Volt and 400 Volt Function: Relaying of full text messages to up to three mobile phones Inclusive: With internal antenna (without SIM card)		28 792
Antenna booster with magnetic base	Compatibility: For <i>TeleControl</i> telemetric system to improve the reception Cable length: 2.5 m		28 793
Extension cable	Compatibility: For antenna booster Cable length: 2 m		28 794

Accessories

Control unit accessories

			Art. no.
Audible alarm	Compatibility: For all warning- and control units Cable length: 20 m		20 162
Potential-free contact	Compatibility: For all control units 230 V; not for warning devices Art. no. 20 222 and 20 223		80 072
	Compatibility: For warning devices Art. no. 20 222 and 20 223		80 074

Alarm unit

			Art. no.
with electrode probe	Function: For monitoring and reporting of flooding; for conductive liquids Inclusive: Visual and audible alarm warning, battery back up, with Logbook, connection for remote alarm speaks (Art. no. 20 162) or upgradable with potential free contact. Voltage: 230 V ~ 50 Hz (IP 54) Plug: 2 pin grounded Cable length: 5 m (extendable up to 30 m)	 	20 222
with optical probe	Function: For monitoring and reporting of flooding; for conductive / non-conductive liquids Inclusive: Visual and audible alarm warning, battery back up, with Logbook, connection for remote alarm speaks (Art. no. 20 162) or upgradable with potential free contact. Voltage: 230 V ~ 50 Hz (IP 54) Plug: 2 pin grounded Cable length: 5 m (extendable up to 30 m)	 	20 223
	Cable length: 10 m (extendable up to 30 m)		20 224

Connector set

			Art. no.
Connector set	Compatibility: For connection to pump/probe cables for connection to the coded connectors from Art. no. 28 731 / 28 746		80 893

USB housing socket

			Art. no.
USB housing socket	Compatibility: For routing the USB connection to the outside of the housing. For 230 Volt Comfort control units Mono/Duo		28 785

Accessories

Safety

Air compressor set

Function: For use in combination with lifting station and pumping stations with pressure control: prevents soiling, avoids the formation of condensate in the pressure hose, makes operation of systems possible with pressure hose lengths > 10 m - 30 m
Inclusive: T-piece connection, 20 m pressure hose



Art. no.

28 048

PE-pressure hose extension (per meter)

Compatibility: For Art. no. 28 048

680 071

Cable extensions

for probe

Compatibility: For warning and control units
Cable length: 10 m



Art. no.

80 889

for pump

Compatibility: For warning and control units
Cable length: 10 m

80 891

4. Drains and channels

For indoor and outdoor installation

Overview of Drains and channels

4.1 Bathroom drains



Bathroom drain
The Ultraflat

➤ Page 196



Wall drain
Scada

➤ Page 228



Bathroom drain
Giro

➤ Page 203



Bathroom drain
Classic

➤ Page 204



Bathroom drain
The Superflat

➤ Page 208



Shower channel
Linearis Infinity

➤ Page 216



Shower channel
Linearis Comfort / Compact

➤ Page 219



4.2 Floor drains



Floor / roof drain
Ecoguss

➤ Page 234



Floor/roof drain
Practicus

➤ Page 240



Floor drain / Channel drains /
Square channel drains












Ferrofix

➤ Page 250



Clean-out
Ferrofix

➤ Page 263

Material	Discharge rate
 Ecoguss	 0.4–0.9 l/s
 Polymer	 1.0–1.9 l/s
 Metal	 > 2.0 l/s
Installation depth	Function
 min. 63 mm	 Protects in the event of backwater
 min. 95 mm	 Protects and disposes in the event of backwater
 min. 130 mm	

4.3 Basement drains



Backwater pumping station
Pumpfix S

➤ Page 283



Basement drain
without backwater valve

➤ Page 292



Backwater valve
Universale Plus

➤ Page 286



4.4 Outdoor drains



Parking deck drains

➤ Page 304



Backwater valve
The Universal

➤ Page 288



Yard drains

➤ Page 307



Backwater valve
Drehfix

➤ Page 289



Gutter drains

➤ Page 315



Basement drain
Light liquid trap

➤ Page 291



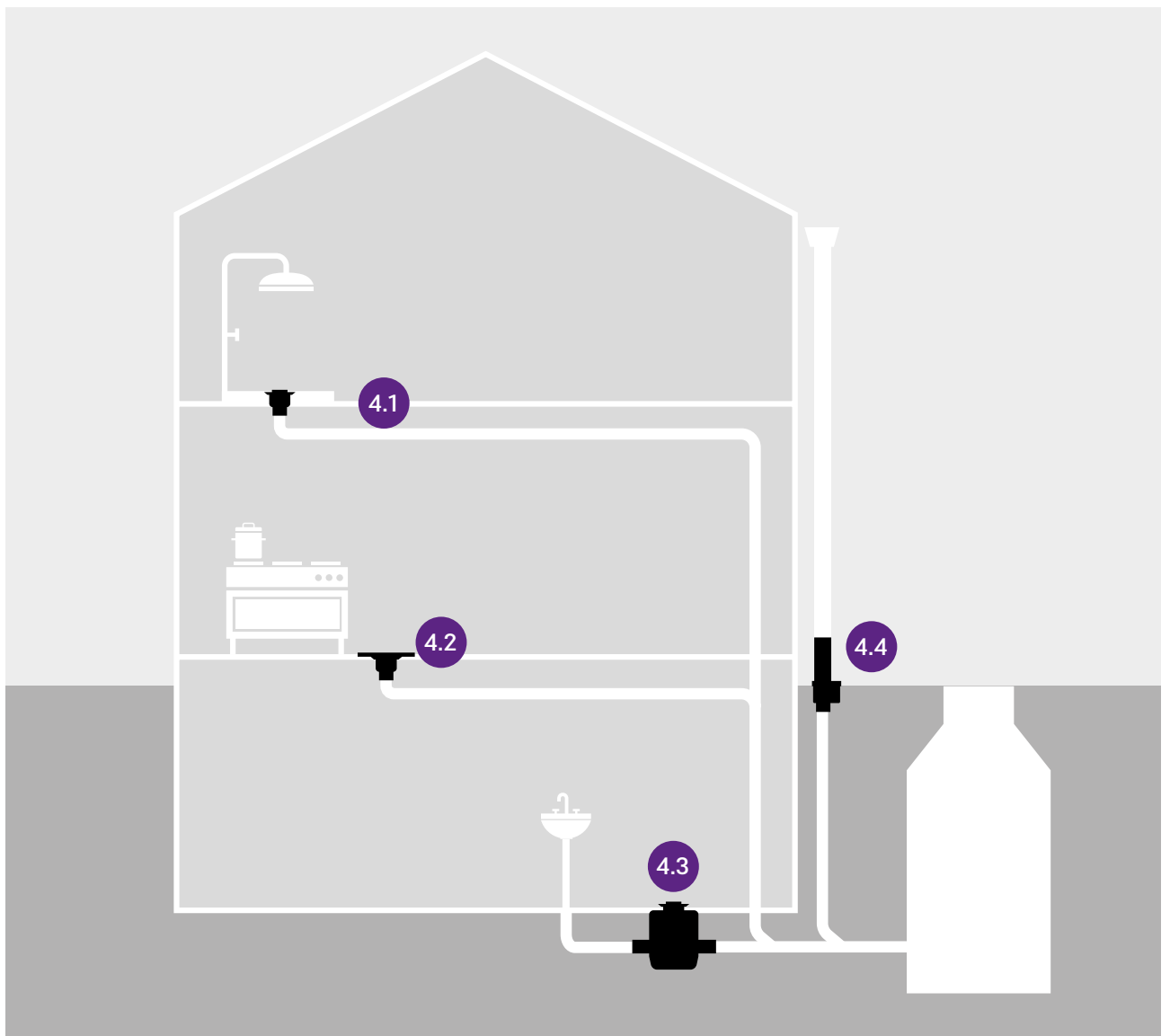
Roof drains for flat roof surfaces

➤ Page 319



Everything specialists need to know

Different types of drains



4.1 Bathroom drains
Bathroom drainage tailored to requirements
➤ Page 192

4.2 Floor drains
Floor drains with versatile properties
➤ Page 230

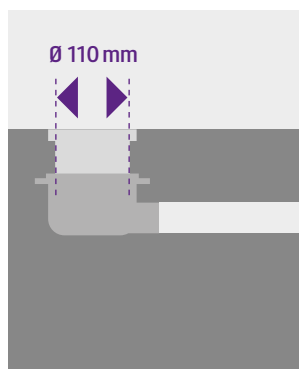
4.3 Basement drains
For dry floors in basement rooms
➤ Page 280

4.4 Outdoor drains
Robust solutions for particular loads
➤ Page 302

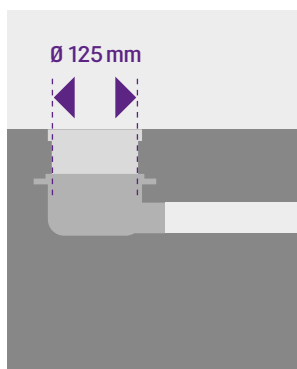
Modular system

With our modular systems, we provide numerous possible drain combinations.

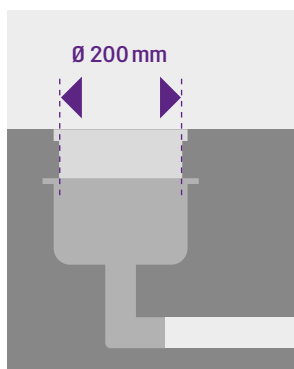
Our extensive offer includes different drain covers, upper sections, drain bodies and other accessories, from which you can individually put together the right drain for you. You can identify which products are compatible with which systems by the corresponding markings on the product pages.



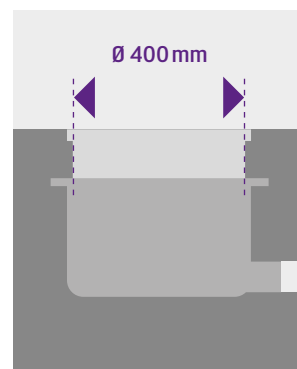
System 100



System 125



System 200



System 400

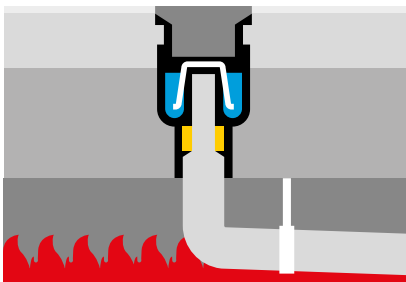
Fire protection

All KESSEL drain systems with a fire protection feature comply with fire resistance class F120. There is no need for preventative fire protection for floor drains in single-, two-family homes, basements and floor drains with horizontal outlets (under certain conditions).

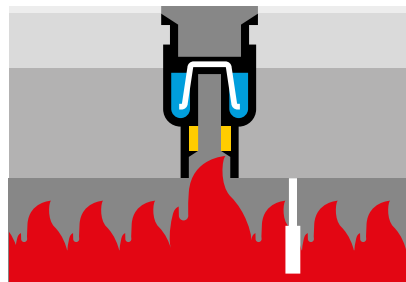
The German State Building Code defines the required fire resistance period in classes as follows:

Fire resistance class	F30	F60	F90	F120
Fire resistance period (minutes)	> 30	> 60	> 90	> 120

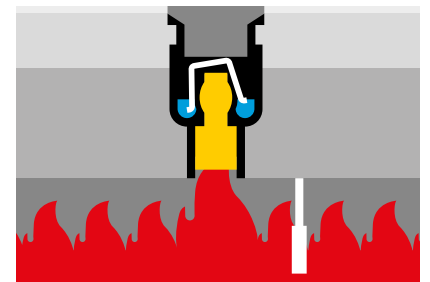
Fire-Kit (Z-19.17-1719, Z-19.53-2414)



Fire burns away all exposed plastic pipe. The flames then reach the outlet of the drain body.



The odour trap built into the drain body combines with sealing water to prevent smoke and gas reaching upper levels of the building.

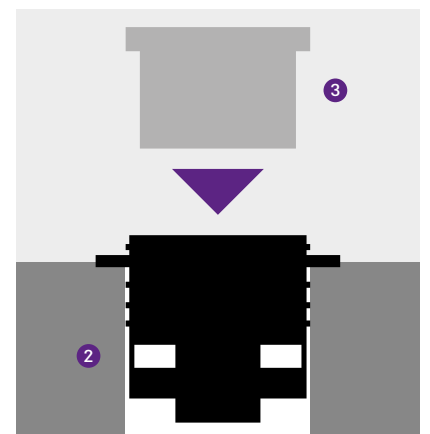
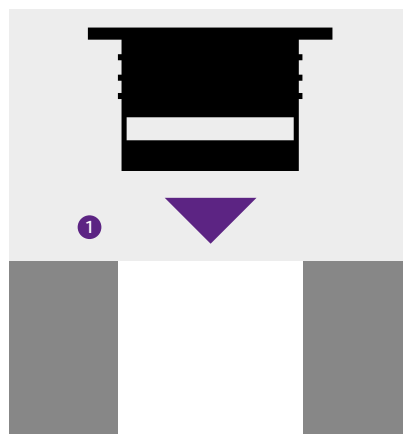


The *Fire-Kit* fire protection insert expands due to the heat and completely seals off the openings in the concrete floor, preventing fire from spreading to the floor above.

Quick-Fit (DIBt Certification)

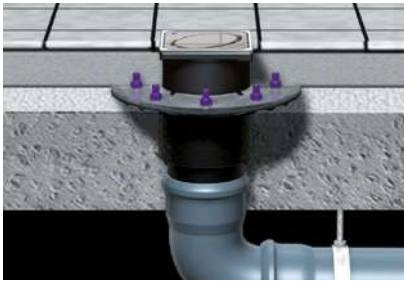
The fire-protection insert provides the necessary fire protection. This is attached by a metal hoop on the lower end of the installation aid. In the event of a fire, the fire protection mass swells up and closes the gap resulting from the melting seal. This guarantees a smoke-tight closure and prevents the fire from spreading to the floor above.

- 1 Insert *Quick-Fit* in core hole (Ø 160 mm).
- 2 Lower the *Ecoguss* drain body with vertical outlet into *Quick-Fit*.
- 3 Fit the upper section.

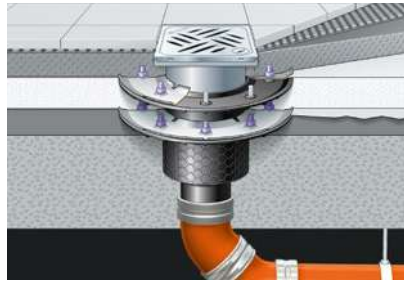


Waterproofing options

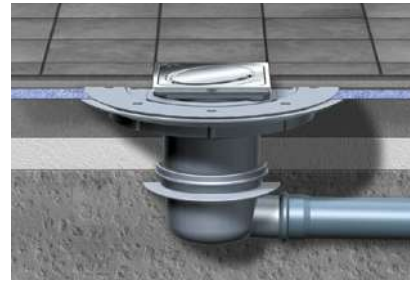
The EN 1253 standard requires a waterproofing seal in wet rooms.



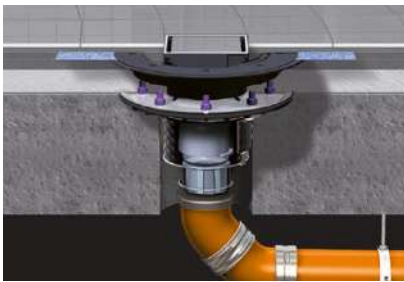
Single waterproofing flange



Double waterproofing flanges



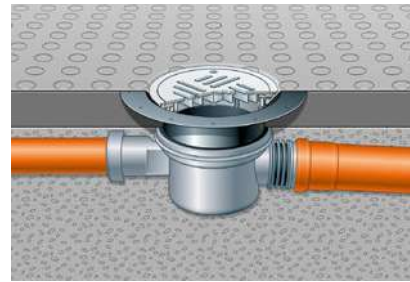
Shallow waterproofing flange



Shallow and lower waterproofing flange



Waterproofing flange for impermeable concrete



Waterproof flooring

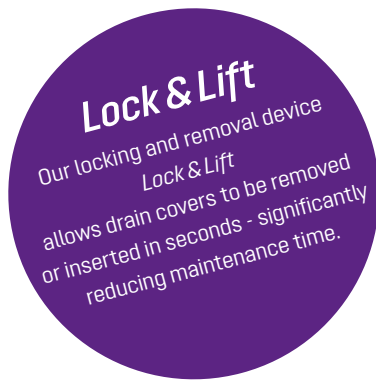
Sound Protection

The Fraunhofer Institute in Stuttgart measured the following noise levels for KESSEL floor/ceiling drains:

Drains	DIN 4109	VDI 4100 SST II
Project drain <i>Ecoguss</i>	16 DB (A)	14 DB (A)
Project drain <i>Practicus</i>	18 DB (A)	15 DB (A)
Bathroom drain <i>The Ultraflat 54</i>	14 DB (A)	19 DB (A)
Bathroom drain <i>The Ultraflat 79</i>	15 DB (A)	11 DB (A)
Shower channel <i>Linearis Infinity 60</i>	17 DB (A)	14 DB (A)
Shower channel <i>Linearis Infinity 90</i>	15 DB (A)	12 DB (A)
Shower channel <i>Linearis Comfort</i>	17 DB (A)	13 DB (A)
Shower channel <i>Linearis Compact</i>	14 DB (A)	10 DB (A)
Wall drain <i>Scada</i>	17 DB (A)	14 DB (A)

Odour traps

KESSEL drains have a removable odour trap to protect against unpleasant odours from the sewer. Certain models can also be optionally equipped with the waterless odour, foam and rodent stop *Multistop* or the mechanical odour trap *Megastop* with water seal. Combined with the locking and removal device *Lock & Lift*, the *Megastop* mechanical odour trap can be used as backwater protection up to 0.1 bar.



The right cover

Drains, covers and upper sections must be installed in such a way that they are able to cope with potential loads at the place of installation. The two standards EN 1253-1 (Gullies for buildings) and EN 124 (Gully tops and manhole tops for vehicular and pedestrian areas). In cases of doubt, the higher class must always be chosen.

Covers and upper sections to EN 1253-1

Class H 1.5	Load class up to max. 150 kg Unused roof space (no traffic)
Class K 3	Load class up to max. 300 kg Areas without vehicular traffic, such as bathrooms at home, retirement homes, hotels, schools, swimming baths, public washing and shower facilities, balconies, loggias, terraces and green roofs.
Class L 15	Load class up to max. 1.5 t Areas with light vehicular traffic such as cycleways and domestic drives.
Class R 50	Load class up to max. 5.0 t Used roof space (roof parking area)
Class M 125	Load class up to max. 12.5 t Areas with vehicular traffic, such as car parks, factories and workshops - not including light commercial vehicles or heavy wheel loads.

Covers and upper sections to EN 124

Class A 15	Group 1 For use in areas where only pedestrians have access.
Class B 125	Group 2 For use in car parks and pedestrian areas where only occasional vehicular access is likely.
Class C 250	Group 3 For use in car parks, forecourts, industrial sites and areas with slow moving traffic also in highway locations up to 500 mm from the kerb and up to 200 mm into the verge, excluding motorways.
Class D 400	Group 4 For use in areas where cars and lorries have access, including carriageways, hard shoulders and pedestrian areas.
Class E 600	Group 5 For use in areas with heavy traffic - military, airports, ports.

The right material

Drains are offered in a range of different materials. Which material is used depends on the requirements set by the type of wastewater to be discharged.



Polymer (PP or ABS)

Drains made of polymer are generally characterised by their high impact resistance, light weight and simple design.



Ecoguss

Building drains made of the composite material *Ecoguss* are naturally hygienic and highly resistant to chemicals on account of the smooth and corrosion-free surface. Additional protective coatings are not necessary. Weight approx. 70 % lower than cast iron drains, no electrical grounding necessary and suitable for installation in hot bitumen thanks to high-temperature resistance properties.



Metal

Classic metal drains are hygienic, heat resistant and generally load resistant. They are therefore primarily suitable for extreme conditions in commercial and industrial premises.

Medium	Ecoguss resistant	Medium	Ecoguss resistant	Medium	Ecoguss heavy duty
1,1,1-trichloroethane	RT ✓	Kerosine	RT ✓	Acetone	RT ✓
Acetic acid	99 % RT ✓	Methanol	RT ✓	Petrol	RT ✓
Acetone	RT ✓	Methyl-tert.-butyl ether	RT ✓	Brake fluid (Toyota)	RT ✓
Formic acid	85 % RT ✓	Lactic acid	90 % RT ✓	Butyl alcohol, n-butanol	RT ✓
Ammoniac	24.5 % RT ✓	Motor oil	150° ✓	Diesel	RT ✓
Petrol/benzene mixture	RT ✓	Sodium chloride, saturated	RT ✓	Diethyl ether	RT ✓
Brake fluid	RT ✓	Sodium hypochlorite	80° ✓	Ethanol	RT ✓
Butyl alcohol, n-butanol	RT ✓	Sodium base liquor	30 % RT ✓	Isopropanol	RT ✓
Calcium chloride	RT ✓	Sodium base liquor	50 % RT ✓	Potassium chromate 30%	RT ✓
Calcium base liquor	RT ✓	n-butyl acetate	RT ✓	Potassium base liquor 45%	RT ✓
Chlorine solution	25 % RT ✓	n-hexane	RT ✓	Methanol	RT ✓
Diesel	RT ✓	Phosphoric acid	40 % RT ✓	Motor oil	150° ✓
Diethyl ether	RT ✓	Rapeseed methyl ester	RT ✓	Sodium chloride, saturated	RT ✓
Acetic acid	99 % RT ✓	Reference petrol C, ASTM D-471	RT ✓	Sodium base liquor 30%	RT ✓
Ethanol	RT ✓	Nitric acid	10 % RT ✓	Sodium base liquor 50%	RT ✓
Ethylene glycol	RT ✓	Nitric acid	65 % RT ✓	n-butyl acetate	RT ✓
FAM-DIN 51604-A	RT ✓	Hydrochloric acid	37 % RT ✓	n-hexane	RT ✓
FAM-DIN 51604-B	RT ✓	Sulphuric acid	37 % RT ✓	Silicone oil	RT ✓
FAM-DIN 51604-C	RT ✓	Silicone oil	RT ✓	Toluene	RT ✓
Frigene 114 (tetrafluorodichloroethane)	RT ✓	Toluol	RT ✓	Water up to 1000 h	90° ✓
Frigene R134 Aral Alur EE32	+ 5 % RT ✓	Water 90°C up to 1000 h	RT ✓	Water, cold	RT ✓
Hydraulic fluid	RT ✓	Water, cold	RT ✓	Xylene	RT ✓
Isopropanol	RT ✓	Xylene	RT ✓		
Potassium chromate	30 % RT ✓	Zinc chloride solution	50 wt.% RT ✓		
Potassium base liquor	45 % RT ✓	Zinc chloride solution	10 % RT ✓		
Potassium permanganate (80°)	6 % RT ✓	Citric acid	RT ✓		

Medium	PP	Medium	ABS
Acetone	100 % 23° ✓	Acetone	-
Formic acid	98 % 23° ✓	Formic acid	40 % to 50° ✓
Ammonium sulphate	to 100° ✓	Ammonium sulphate	saturated to 100° ✓
Amyl alcohol	60° ✓	Amyl alcohol	23° ✓
Petrol/benzene mixture	23° ✓	Petrol/benzene mixture	-
Brake fluid	to 60° ✓	Brake fluid	-
Bromine	-	Bromine	-
Butane	to 60° ✓	Butane	23° ✓
Calcium hypochlorite	12.5 % active Cl to 60° ✓	Calcium hypochlorite	saturated to 50° ✓
Chlorine, liquid	-	Chlorine, liquid	-
Citric acid	saturated to 100° ✓	Citric acid	saturated to 50° ✓
Acetic acid	100 % 23° ✓	Acetic acid	to 50 % to 50° ✓
Hydrofluoric acid	40 % to 60° ✓	Hydrofluoric acid	40 % 23° ✓
Formaldehyde	to 60° ✓	Formaldehyde	30 % 50° ✓
Glycerine	100 % to 60° ✓	Glycerine	to 50° ✓
Magnesium chloride	saturated to 100° ✓	Magnesium chloride	saturated to 50° ✓
Methanol	100 % to 60° ✓	Methanol	to 20° ✓
Lactic acid	10 % to 60° ✓	Lactic acid	10 % to 50° ✓
Motor oil	23° ✓	Motor oil	to 50° ✓
Sodium chloride	saturated to 100° ✓	Sodium chloride	saturated to 50° ✓
Sodium thiosulphate	saturated to 60° ✓	Sodium thiosulphate	saturated to 50° ✓
Nitrobenzene	100 % 60° ✓	Nitrobenzene	-
Perchloroethylene	23° ✓	Perchloroethylene	-
Phenol	saturated to 60° ✓	Phenol	10 % 50° ✓
Propanol	100 % to 60° ✓	Propanol	to 50° ✓
Nitric acid	50 % 23° ✓	Nitric acid	30 % 23° ✓
Hydrochloric acid	to 60° ✓	Hydrochloric acid	37 % 23° ✓
Sulphuric acid	to 10 % to 100° ✓	Sulphuric acid	to 50 % 50° ✓
Detergent	ready to use to 60° ✓	Detergent	ready to use 23° ✓
Nitrogen peroxide	3 % to 100° ✓	Nitrogen peroxide	3 % to 50° ✓

- ✓ extremely resistant
- ✓ moderately resistant
- not for use
- RT Room temperature

4.1 Bathroom drains

Bathroom / shower drains /
wall drains and channels





Bathroom drain

The Ultraflat

The ultra low profile drain - ideal for remodelling / renovation work.

Here the name speaks for itself: the *Ultraflat* is our flattest bathroom drain and is thus predestined for renovation work in existing buildings. *The Ultraflat* can be combined with different design covers and, despite its compact size, provides a high discharge rate of 0.6 to 1.0 l/s.

The Ultraflat 54 has a minimum installation depth of 63 mm (54 mm up to top of flange) with outlet nominal sizes Ø 40 mm and Ø 50 mm, or as *The Ultraflat 79* with a minimum installation depth of 88 mm (79 mm up to top of flange) with outlet nominal size Ø 50 mm.



1 Drain 2 Waterproofing membrane 3 Drain pipe 4 Cover

Odour traps

The Ultraflat has a removable odour trap to protect against unpleasant odours from the sewer. Certain models can also be optionally equipped with the waterless odour, foam and rodent stop *Multistop* or the mechanical odour trap *Megastop* with water seal. Combined with the locking and removal device *Lock&Lift*, the *Megastop* mechanical odour trap can be used as backwater protection up to 0.1 bar.



Illustration shows *Multistop*
Art. no. 48 500



Illustration shows *Megastop*
Art. no. 48 550



Convenient cleaning and maintenance

The locking and removal device *Lock & Lift* makes inserting and locking or unlocking and removing the cover ultra fast. This saves time during mandatory cleaning in the commercial sector.



Low installation depth

Our low-profile bathroom drains *The Superflat* and *The Ultraflat* are particularly suitable for renovation projects thanks to their low installation depths.

On request, *The Ultraflat* can also be supplied as a drain body. This opens up numerous possible combinations with the upper sections and accessories of the modular system 125.

- Drain body: page 200
- Further accessories: page 202

The polymer installation kit is used to fix *The Ultraflat* in the correct position before installation.

- Installation kit: page 202

Floor drain *The Ultraflat 54*

with standard odour trap

System 125



Made in ABS

Specifications:

With lateral outlet, removable odour trap in the upper section, sealing water height 22 mm and with factory-mounted or non-mounted** waterproofing membrane according to

EN 1253-1 and DIN 18534-1-W3-I.

Drainage capacity in l/sec

with 20 mm / 10 mm threshold

Ø 40: 0.8 (*0.9) l/sec / 0.7 l/sec

Ø 50: 0.8 l/sec / 0.6 l/sec.

Installation height 63 – 121 mm.

Installation area 350 × 350 mm

Cover:

Design cover *Kessel* 120 × 120 mm

(anti-slip class R9 according to DIN 51130;

anti-slip class C according to DIN 51097)

and rim made of stainless steel AISI 304

(rim height: 9 mm without *Lock & Lift* locking

system, 16 mm with *Lock & Lift* locking

system), class L 15 or

slotted cover 120 × 120 mm made of stainless

steel AISI 304, rim height 9 mm, class K 3



Illustration shows floor drains with *Lock & Lift* locking system

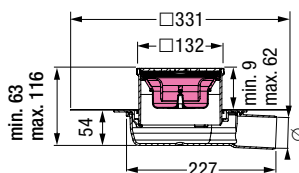


Illustration shows Art. no. 44 740.62M, 44 750.62M, 44 740.20M, 44 750.20M

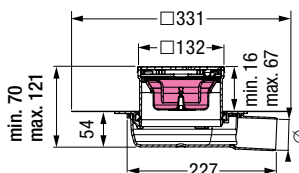


Illustration shows floor drains with *Lock & Lift* locking system

Outer diameter Ø (mm) Art. no.

With design cover, without *Lock & Lift* locking system

Ø 40 44 740.62M

Ø 50 44 750.62M

Ø 40** 44 740.62

Ø 50** 44 750.62

With slotted cover, without *Lock & Lift* locking system

Ø 40 44 740.20M

Ø 50 44 750.20M

Ø 40** 44 740.20

Ø 50** 44 750.20

With design cover, with *Lock & Lift* locking system

Ø 40* 44 740.63M

Ø 50 44 750.63M

Ø 40** 44 740.63

Ø 50** 44 750.63

*drainage capacity Ø 40: 0.9 l/sec with 20 mm threshold

**with non-mounted waterproofing membrane

Floor drain *The Ultraflat 54*

with mechanical odour trap *Megastop*

System 125



Made in ABS

Specifications:

With lateral outlet, mechanical odour trap

Megastop in the upper section, hair filter,

backwater-proof up to 0.1 bar and

with factory-mounted waterproofing

membrane according to EN 1253-1 and

DIN 18534-1-W3-I.

Drainage capacity in l/sec

with 20 mm / 10 mm threshold

Ø 40: 0.7 l/sec / 0.6 l/sec

Ø 50: 0.6 l/sec / 0.55 l/sec.

Installation height 70 – 121 mm.

Installation area 350 × 350 mm

Cover:

Design cover *Kessel* 120 × 120 mm

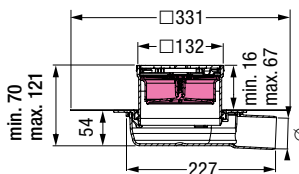
(anti-slip class R9 according to DIN 51130;

anti-slip class C according to DIN 51097)

and rim made of stainless steel AISI 304

(rim height: 16 mm), class L 15,

with *Lock & Lift* locking system



Outer diameter Ø (mm) Art. no.

Ø 40 44 740.66M

Ø 50 44 750.66M

Floor drain *The Ultraflat 79*

with standard odour trap

System 125



Made in ABS

Specifications:

With lateral outlet, removable odour trap in the upper section, sealing water height 50 mm according to EN 1253-1 and Art. no. **44 700.20M** incl. clip flange with factory-mounted waterproofing membrane according to EN 1253-1 and DIN 18534-1-W3-I.

Drainage capacity in l/sec with 20 mm / 10 mm threshold
 Ø 50: 1.15 l/sec / 0.95 l/sec.
 Installation height 88 – 145 mm.
 Installation area 350 × 350 mm

Cover:

Design cover *Kessel* 120 × 120 mm (anti-slip class R9 according to DIN 51130; anti-slip class C according to DIN 51097) and rim made of stainless steel AISI 304 (rim height: 9 mm without *Lock & Lift* locking system, 16 mm with *Lock & Lift* locking system), class L 15 or slotted cover 120 × 120 mm made of stainless steel AISI 304, rim height 9 mm, class K 3

Note:

In combination with clip flange Art. no. 44 703 waterproofing layer according to DIN 18534-1-W3-I possible



Illustration shows Art. no. 44 700.63 with *Lock & Lift* locking system

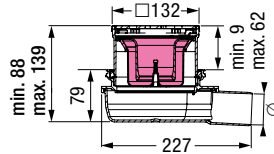


Illustration shows Art. no. 44 700.62, 44 700.20

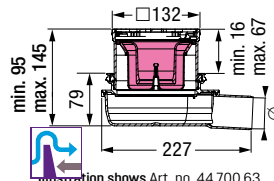


Illustration shows Art. no. 44 700.63

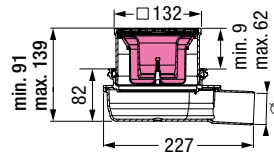


Illustration shows Art. no. 44 700.20 M

Outer diameter Ø (mm) Art. no.

With design cover, without *Lock & Lift* locking system

Ø 50 44 700.20

With slotted cover, without *Lock & Lift* locking system

Ø 50 44 700.20

Ø 50 44 700.20M

With design cover, with *Lock & Lift* locking system

Ø 50 44 700.63

Floor drain *The Ultraflat 79*

with mechanical odour trap *Megastop*

System 125



Made in ABS

Specifications:

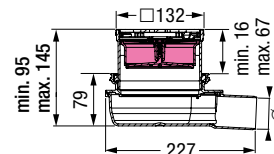
With lateral outlet, mechanical odour trap *Megastop* in the upper section, hair filter, backwater-proof up to 0.1 bar.
 Drainage capacity in l/sec with 20 mm / 10 mm threshold
 Ø 50: 1.1 l/sec / 0.7 l/sec.
 Installation height 95 – 145 mm.
 Installation area 350 × 350 mm

Cover:

Design cover *Kessel* 120 × 120 mm (anti-slip class R9 according to DIN 51130; anti-slip class C according to DIN 51097) and rim made of stainless steel AISI 304 (rim height: 16 mm), class L 15, with *Lock & Lift* locking system

Note:

In combination with clip flange art. no. 44 703 waterproofing layer according to DIN 18534-1-W3-I possible



Outer diameter Ø (mm) Art. no.

Ø 50 44 700.66

Floor drain *The Ultraflat 79*

with *Variofix* shallow bed upper section with design cover *Kessel*

System 125



Made in ABS

Specifications:

With lateral outlet, removable odour trap in the upper section, sealing water height 50 mm according to EN 1253-1 and with non-mounted waterproofing membrane according to EN 1253-1 and DIN 18534-1-W3-I.

Drainage capacity in l/sec
with 20 mm / 10 mm threshold
Ø 50: 1.45 l/sec / 1.25 l/sec.

Installation height 129 – 184 mm.

Installation area 350 × 350 mm

Cover:

Design cover *Kessel* 120 × 120 mm (anti-slip class R9 according to DIN 51130; anti-slip class C according to DIN 51097) and rim made of stainless steel AISI 304 (rim height: 10 – 23 mm), class L 15



Illustration shows Art. no. 44 700.53
with *Lock & Lift* locking system

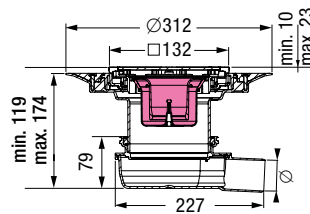


Illustration shows Art. no. 44 700.52, 44 700.53

Outer diameter Ø (mm)

Art. no.

With design cover, without *Lock & Lift* locking system

Ø 50

44 700.52

With design cover, with *Lock & Lift* locking system

Ø 50

44 700.53

Floor drain *The Ultraflat 79*

with *Variofix* shallow bed upper section with slotted cover



Made in ABS

Specifications:

With lateral outlet, removable odour trap in the upper section, sealing water height 50 mm according to EN 1253-1

and with non-mounted waterproofing membrane according to EN 1253-1 and DIN 18534-1-W3-I.

Drainage capacity in l/sec with 20 mm / 10 mm threshold
 Ø 50: 1.3 l/sec / 1.2 l/sec.

Installation height 129 – 184 mm.

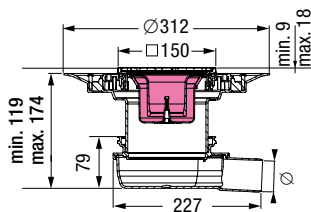
Installation area 350×350 mm

Cover:

Slotted cover 138×138 mm

and rim made of stainless steel AISI 304

(rim height: 9 – 18 mm), screwed, class K 3



Outer diameter Ø (mm)	Art. no.
Ø 50	44 700.51

With slotted cover, screwed

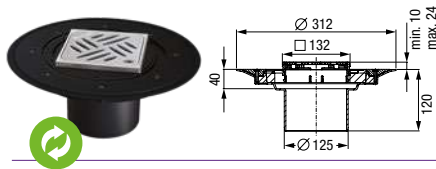
Modular system 125

The Ultraflat 54 and The Ultraflat 79

System 125

Variofix shallow bed upper sections

with covers in stainless steel



with design cover

in stainless steel AISI 304 or AISI 316L

Material: ABS, rim in stainless steel

Class: L 15 (Kessel, Oval) / K 3 (Spot, Slot)

Tile thickness: 8 – 21 mm

Cover: 120×120 mm

Anti-slip class design cover Kessel:

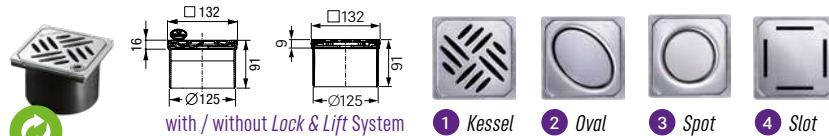
R9 according to DIN 51130; C according to DIN 51097

Inclusive: Waterproofing membrane

Cover	Art. no.	Cover	Art. no.
with Lock & Lift System		without Lock & Lift System	
1	AISI 304 48 904	1	AISI 304 48 625
2	AISI 304 48 905	2	AISI 304 48 626
3	AISI 304 48 621	3	AISI 304 48 620
4	AISI 304 48 619	4	AISI 304 48 618
1	AISI 316L 48 204	2	AISI 316L 48 670
2	AISI 316L 48 669		

Upper sections

with covers in stainless steel



with design cover

in stainless steel AISI 304 or AISI 316L

Material: ABS, rim in stainless steel

Class: L 15 (Kessel, Oval) / K 3 (Spot, Slot)

Cover: 120×120 mm

Anti-slip class design cover Kessel:

R9 according to DIN 51130;

C according to DIN 51097

Cover	Art. no.	Cover	Art. no.
with Lock & Lift System		without Lock & Lift System	
1	AISI 304 48 201	1	AISI 304 48 225
2	AISI 304 48 202	2	AISI 304 48 226
3	AISI 304 48 221	3	AISI 304 48 220
4	AISI 304 48 219	4	AISI 304 48 218
1	AISI 316L 48 203	2	AISI 316L 48 228
2	AISI 316L 48 227		

with slotted cover

in stainless steel AISI 304

Material: ABS

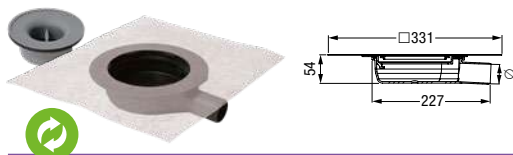
Class: K 3

Cover: 120×120 mm

AISI 304 Art. no. 48 165

Drain body The Ultraflat 54

with odour trap for installation in an upper section



Lateral outlet Ø 40 / Ø 50

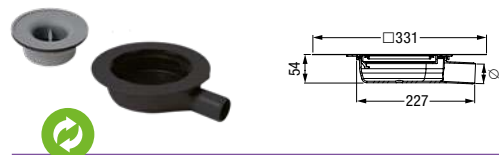
Sealing water height: 22 mm

Inclusive:

- Odour trap for installation in an upper section
- Factory-mounted waterproofing membrane according to EN 1253-1 and DIN 18534-1-W3-I

Ø 40 Art. no. 44 740M

Ø 50 Art. no. 44 750M



Lateral outlet Ø 40 / Ø 50

Sealing water height: 22 mm

Inclusive:

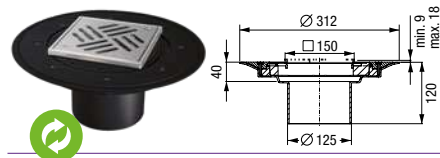
- Odour trap for installation in an upper section
- Non-mounted waterproofing membrane according to EN 1253-1 and DIN 18534-1-W3-I

Ø 40 Art. no. 44 740

Ø 50 Art. no. 44 750

Variofix shallow bed upper sections

with covers in stainless steel



with slotted cover

in stainless steel AISI 304 or AISI 316L

Material: ABS, rim in stainless steel

Class: K 3

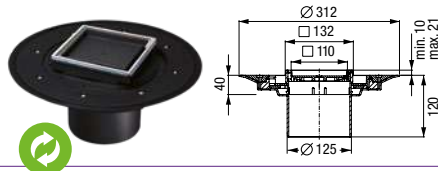
Tile thickness: 9 – 18 mm

Cover: 138×138 mm, screwed

Inclusive: Waterproofing membrane

AISI 304 **Art. no. 48 963**

AISI 316L **Art. no. 48 206**



with recessed polymer cover

for on-site tiling

Material: ABS, rim in stainless steel AISI 304

Class: K 3

Tile thickness: 10 – 21 mm

Cover: 110×110 mm (polymer)

Inclusive: Waterproofing membrane

AISI 304 **Art. no. 48 906**

Upper sections

with covers in stainless steel and polymer



with slotted cover

in stainless steel AISI 304

Material: ABS, rim in stainless steel

Class: L 15

Cover: 138×138 mm, screwed

AISI 304 **Art. no. 48 951**



with slotted cover

in stainless steel AISI 304 / 316L or ABS

Material: ABS

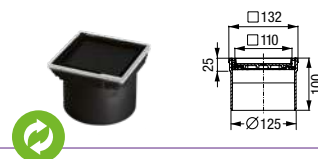
Class: K 3

Cover: 138×138 mm, screwed (only in stainless steel)

AISI 304 **Art. no. 48 950**

AISI 316L **Art. no. 48 209**

ABS **Art. no. 48 193, black**



with tileable cover

made of polymer

Material: ABS, rim in stainless steel

AISI 304 or 316L

Class: K 3

Cover: 110×110 mm

AISI 304 **Art. no. 48 211, rim in stainless steel**

AISI 316L **Art. no. 48 207, rim in stainless steel**

Drain body The Ultraflat 79

with odour trap for installation in an upper section



Lateral outlet Ø 50 without inlet

Sealing water height: 50 mm

Ø 50 **Art. no. 44 700**



Lateral outlet Ø 50 with inlet Ø 40

Sealing water height: 50 mm

Ø 50 **Art. no. 44 701**


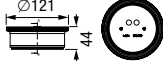

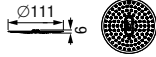




Accessories

System 125

The Ultraflat 54 and The Ultraflat 79

Hygiene and odour stop

				Art. no.
Megastop	Compatibility: Floor drain <i>The Ultraflat</i> Function: Mechanical odour trap inclusive hair filter for KESSEL upper sections, in combination with design cover with <i>Lock & Lift</i> system additional protection against backwater up to 0.1 bar			48 550
Hair filter	Compatibility: For <i>Megastop</i> and floor drain <i>The Ultraflat</i>			44 704
Multistop	Compatibility: Floor drain <i>The Ultraflat</i> Function: Odour, foam, rodent and insect stop			48 500

Installation aid

				Art. no.
for fixing the drain bodies	Compatibility: Floor drain <i>The Ultraflat</i> Inclusive: Fastening material, Sound and settlement absorber			44 702

Clip flange

				Art. no.
	Compatibility: Floor drain <i>The Ultraflat</i> Inclusive: Factory-mounted waterproofing membrane in accordance with EN 1253-1 and DIN 18534-1-W3-1			44 703

Transition section

			Outer diameter Ø (mm)	Art. no.
Transition section	Compatibility: Floor drain <i>The Ultraflat</i> Inclusive: Sealing ring Ø 50			Ø50/40 27 118

Glue flange

				Art. no.
without connection flange	Compatibility: Floor drain <i>The Ultraflat</i> Material: ABS			48 409

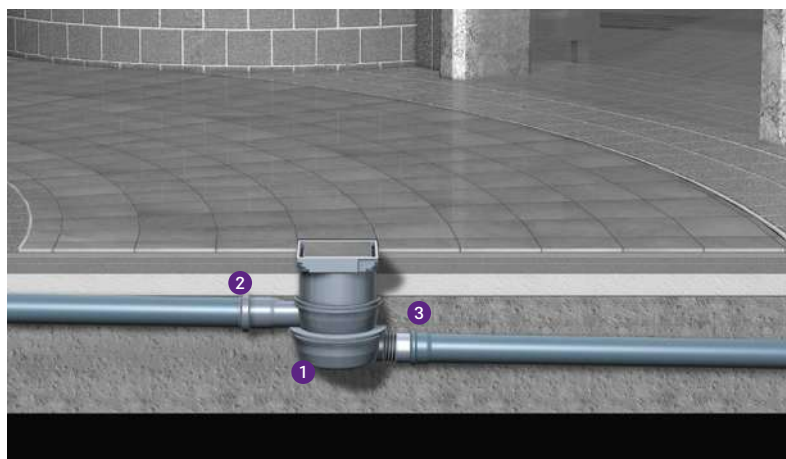
Bathroom drain *Giro*

The rotatable drain for flexible design.

The *Giro* bathroom drain quite literally opens up all options to you. Its inlet can be rotated 360 degrees, to align the outlet as required. And thanks to the flexible outlet, connecting to the pipe system is even easier. This gives you maximum flexibility for your bathroom design.

High degree of user comfort

As the *Giro* is sound insulated, it is extremely effective at absorbing sounds from the pipe system. The integrated odour trap also prevents foul-smelling gas from the sewer from reaching the bathroom.

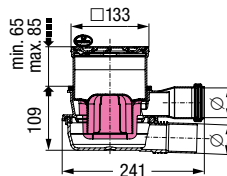


1 Drain 2 Inlet 3 Outlet

Bathroom drain *Giro* with slotted cover in stainless steel



EN 1253



Made in PP. With removable odour trap, fixed lip seal, with rotatable lateral inlet Ø 50, flexible outlet Ø 50, sound-absorbing. Drainage capacity 1.3 l/sec flow rate. Installation area 350 × 250 mm. With upper section in ABS

Cover:

Slotted cover 120 × 120 mm in stainless steel AISI 304, class K 3

Note:

Upper sections can cut and shortened to reach a minimum installation height.

Outer diameter Ø (mm)	Art. no.
Ø 50	45 101.20

Bathroom drain *Classic*

The compact drain with all-rounder qualities.

The *Classic* model is the all-rounder among our bathroom drains. Its compact size, lateral or vertical outlet and various installation options make it particularly versatile. The flow rate is 0.8 l/s.

Modular design

As part of the modular system 100, the *Classic* can be adjusted any way required and can be combined with numerous accessories – for example, with the Multistop odour trap or a glued flange as a moisture seal.



1 Drain 2 Outlet 3 Adhesive flange 4 Steel cover

Bathroom drain *Classic* with *Variofix* shallow bed upper section

System 100



EN 1253-1

Made in ABS, with removable odour trap, sealing water height 50 mm, with fixed lip seal. Drainage capacity 0.8 l/sec flow rate. Installation area 220 × 180 mm

With *Variofix* shallow bed upper section in ABS, with non-mounted waterproofing membrane according to EN 1253-1 and DIN 18534-1-W3-I for shallow bed sealing

Cover:

Design cover *Oval* 120 × 120 mm and rim made of stainless steel AISI 304, for tile thicknesses 8 – 21 mm, class L 15;

standard slotted cover 95 × 95 mm made of stainless steel AISI 304, for tile thicknesses 6 – 14 mm, class K 3 or

slotted cover 138 × 138 mm and rim made of stainless steel AISI 304, for tile thicknesses 8 – 16 mm, class L 15



Illustration shows Art. no. 40 150.54 with *Lock & Lift* locking system

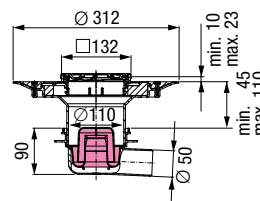


Illustration shows Art. no. 40 150.54

Lateral outlet Vertical outlet

Outer diameter Ø (mm)	Art. no.	Art. no.
--------------------------	----------	----------

With design cover *Oval* with *Lock & Lift* locking system

Ø 50	40 150.54	40 250.54
Ø 75	40 170.54	40 270.54

With standard slotted cover

Ø 50	40 150.50	40 250.50
Ø 75	40 170.50	40 270.50

With slotted cover

Ø 50	40 150.51	40 250.51
Ø 75	40 170.51	40 270.51

Bathroom drain *Classic*

with twin sealing flanges

System 100



Type Tested and Monitored
www.tuv.com
ID 111124461

EN 1253-1

Made in ABS, with removable odour trap, sealing water height 50 mm, with fixed lip seal. Drainage capacity 0.8 l/sec flow rate. Installation area 260 × 180 mm

With *Variofix* shallow bed upper section in ABS, with glue flange and counter flange, with non-mounted waterproofing membrane according to EN 1253-1 and DIN 18534-1-W3-I, with two sealing strips

Cover:

Slotted cover 95 × 95 mm in stainless steel AISI 304, for tile thickness 6 – 14 mm, class K 3



Illustration shows Art. no. 40 159.50

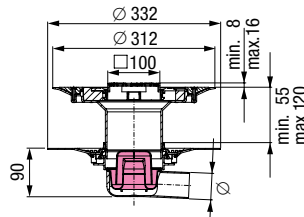


Illustration shows Art. no. 40 159.50

Lateral outlet

Outer diameter Ø (mm)	Art. no.
Ø 50	40 159.50
Ø 75	40 179.50

Vertical outlet

Outer diameter Ø (mm)	Art. no.
Ø 50	40 259.50
Ø 75	40 279.50

Bathroom drain *Classic*

with glue flange

System 100



Type Tested and Monitored
www.tuv.com
ID 111124461

EN 1253-1

Made in ABS, with removable odour trap, sealing water height 50 mm, with fixed lip seal. Drainage capacity 0.8 l/sec flow rate. Installation area 180 × 180 mm

With upper section in ABS, with glue flange and counter flange

Cover:

Slotted cover 100 × 100 mm in stainless steel AISI 304, class K 3



Illustration shows Art. no. 40 250.90

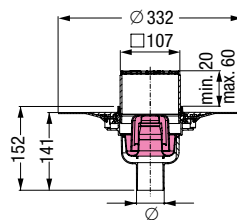


Illustration shows Art. no. 40 250.90

Lateral outlet

Outer diameter Ø (mm)	Art. no.
Ø 50	40 150.90
Ø 75	40 170.90

Vertical outlet

Outer diameter Ø (mm)	Art. no.
Ø 50	40 250.90
Ø 75	40 270.90

Bathroom drain *Classic* with connection flange

System 100



Type Tested and Monitored
www.tuv.com
ID 1111244461

EN 1253-1

Made in ABS, with removable odour trap, sealing water height 50 mm, with fixed lip seal. Drainage capacity 0.8 l/sec flow rate. Installation area 220 × 180 mm

With upper section in ABS

Cover:

Recessed polymer drain cover for on-site tiling 110 × 110 mm, class K 3 or slotted cover 100 × 100 mm made of stainless steel AISI 304, class K 3



Illustration shows Art. no. 40 150.66

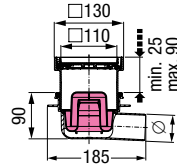


Illustration shows Art. no. 40 150.66



Illustration shows Art. no. 40 150.20

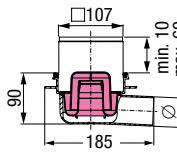


Illustration shows Art. no. 40 150.20

Lateral outlet

Outer diameter Ø (mm)	Art. no.
-----------------------	----------

With recessed polymer drain cover

Ø 50	40 150.66
Ø 75	40 170.66

With slotted cover

Ø 50	40 150.20
Ø 75	40 170.20

Vertical outlet

Outer diameter Ø (mm)	Art. no.
-----------------------	----------

With recessed polymer drain cover

Ø 50	40 250.66
Ø 75	40 270.66

With slotted cover

Ø 50	40 250.20
Ø 75	40 270.20

Bathroom drain *Classic*

with connection flange



EN 1253-1

Made in ABS. Lateral outlet 2.5° / vertical outlet, with removable odour trap, sealing water height 50 mm, with fixed lip seal. Drainage capacity 0.8 l/sec flow rate. Installation area lateral 220×180 mm. Installation area vertical 180×180 mm. With upper section with sealing flange for use with 1 – 4 mm vinyl / synthetic flooring

Cover:

Slotted cover Ø 120 mm made of polymer, grey, class K 3



Illustration shows Art. no. 40 150.30

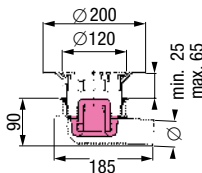


Illustration shows Art. no. 40 170.30



Illustration shows Art. no. 40 250.30

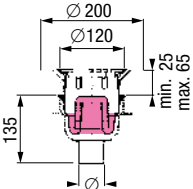


Illustration shows Art. no. 40 270.30

Lateral outlet

Outer diameter Ø (mm)	Art. no.
Ø 50	40 150.30
Ø 75	40 170.30

Vertical outlet

Outer diameter Ø (mm)	Art. no.
Ø 50	40 250.30
Ø 75	40 270.30

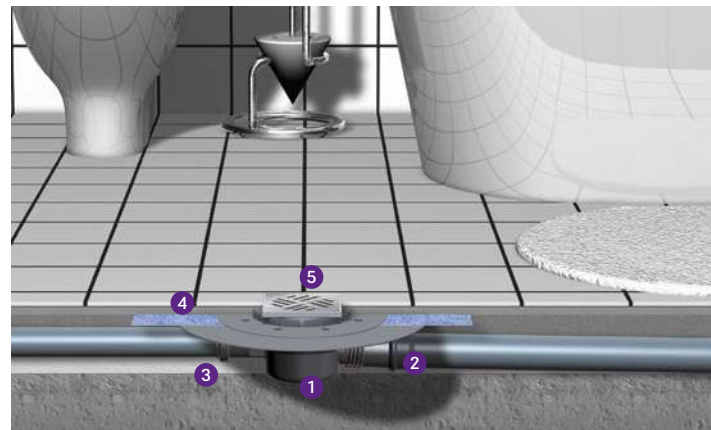
Bathroom drain *The Superflat*

The low profile drain for minimum installation depths.

With its low overall height of 90 mm including cover, the *Superflat* is especially suitable for low installation depths. The upper section can be shortened according to requirements. The flow rate is 0.8 l/s, the outlet is lateral

Modular design

As part of the modular system 100, the *Superflat* can be adjusted any way required and can be combined with numerous accessories – for example, with the Multistop odour trap or a glued flange as a moisture seal.



1 Drain 2 Outlet 3 Inlet 4 Adhesive flange 5 Cover

Bathroom drain *The Superflat* with glue flange

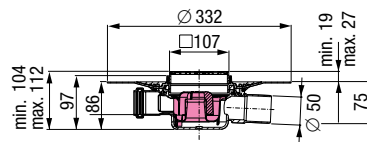
System 100



Made in PP, for shallow bed gasket with lowest installation height. With removable odour trap, glue flange with non-mounted waterproofing membrane according to EN 1253-1 and DIN 18534-1-W3-1 for shallow bed sealing, sound-absorbing, flexible lateral outlet 2.5°, with lateral inlet \varnothing 40 and fixed lip seal. Drainage capacity 0.8 l/sec flow rate. Installation area 260 × 180 mm. With upper section in ABS

Cover:

Slotted cover 100 × 100 mm in stainless steel AISI 304, class K 3



Outer diameter \varnothing (mm)

\varnothing 50

Art. no.

42 701.91

Bathroom drain *The Superflat* with *Variofix* shallow bed upper section

Made in PP, with removable odour trap, sound-absorbing, flexible lateral outlet 2.5°, with lateral inlet Ø 40 and fixed lip seal.

Drainage capacity 0.8 l/sec flow rate.

Installation area 260×180 mm

With *Variofix* shallow bed upper section in ABS, with non-mounted waterproofing membrane according to EN 1253-1 and DIN 18534-1-W3-I for shallow bed sealing

Cover:

Design cover *Oval* 120×120 mm and rim made of stainless steel AISI 304, for tile thicknesses 8 – 21 mm, class L 15 or standard slotted cover 95×95 mm made of stainless steel AISI 304, for tile thicknesses 6 – 14 mm, class K 3



Illustration shows Art. no. 42 701.54 with *Lock & Lift* System

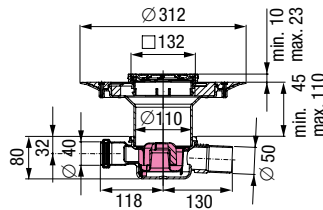


Illustration shows Art. no. 42 701.54

System 100



Lateral outlet

Outer diameter Ø (mm) Art. no.

With design cover *Oval* with *Lock & Lift* locking system

Ø 50 42 701.54

With standard slotted cover

Ø 50 42 701.50

Bathroom drain *The Superflat* with glue flange

Made in PP, with removable odour trap, sound-absorbing, flexible lateral outlet 2.5°, with lateral inlet Ø 40 and fixed lip seal.

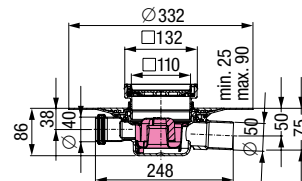
Drainage capacity 0.8 l/sec flow rate.

Installation area 260×180 mm

With upper section in ABS, with glue flange and counter flange

Cover:

Recessed polymer drain cover for on-site tiling 110×110 mm and rim made of stainless steel AISI 304, for tile thicknesses up to 10 mm, with locking system



System 100



Outer diameter Ø (mm) Art. no.

Ø 50 42 701.95

Bathroom drain *The Superflat* with connection flange

Made in PP, with removable odour trap, sound-absorbing, flexible lateral outlet 2.5°, with lateral inlet Ø 40 and fixed lip seal.

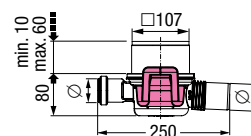
Drainage capacity 0.8 l/sec flow rate.

Installation area 260×180 mm

With upper section in ABS

Cover:

Slotted cover 100×100 mm made of stainless steel AISI 304, min. installation height 90 mm, class K 3



System 100



Outer diameter Ø (mm) Art. no.

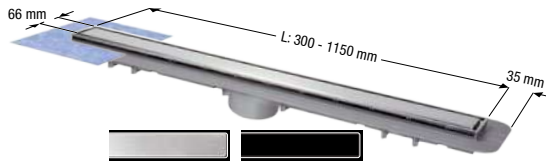
Ø 50 42 701.20

Modular system 100

For body drains *Classic*, *The Superflat* and *Floordrain ME*

Shower channel upper section

with cover in stainless steel AISI 304



Linearis Compact

in stainless steel AISI 304

Material: ABS, rim in stainless steel
Class: K 3
Cover: Can be reversed and tiled on site
Sealing water height: 50 mm
Drainage capacity: 0.6 l/sec (10 mm threshold)
Inclusive: Removable odour trap (remove from all drain bodies during installation), seeping water opening prepared, installation supports and waterproofing membrane

Channel length in mm	Art. no.
300	47 804S
450	47 805S
550	47 806S
650	47 807S
750	47 808S
850	47 809S
950	47 810S
1050	47 811S
1150	47 812S

Variofix shallow bed upper sections

with covers in stainless steel



with design cover Kessel / Oval

in stainless steel AISI 304

Material: ABS, rim in stainless steel
Class: L 15
Tile thickness: 8 - 21 mm
Cover: 120×120 mm
Anti-slip class design cover Kessel: R9 according to DIN 51130; C according to DIN 51097
Inclusive: Waterproofing membrane

Kessel Art. no. 47 904
Oval Art. no. 47 905

Upper sections

with covers in stainless steel



with design covers

in stainless steel AISI 304

Material: ABS, rim in stainless steel
Class: L 15 (*Kessel*, *Oval*) / K 3 (*Spot*, *Slot*)
Cover: 120×120 mm
Anti-slip class design cover Kessel: R9 according to DIN 51130; C according to DIN 51097

Cover	Art. no.	Cover	Art. no.
with <i>Lock & Lift</i> System		without <i>Lock & Lift</i> System	
1	AISI 304 27 201	1	AISI 304 27 225
2	AISI 304 27 202	2	AISI 304 27 226
3	AISI 304 27 221	3	AISI 304 27 220
4	AISI 304 27 219	4	AISI 304 27 218

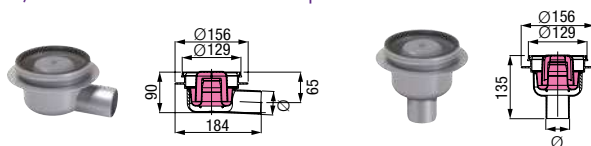
with slotted cover

in stainless steel AISI 304

Material: ABS, rim in stainless steel
Class: K 3 / L 15
Cover: 138×138 mm
 Class K 3 Art. no. 27 196
 Class L 15 Art. no. 27 176, anti-slip

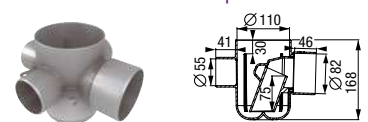
Drain bodies *Classic* in ABS

with / without removable odour trap



Drain body *Floordrain ME* in ABS

with removable odour trap



Lateral outlet / Vertical outlet Ø 50 / Ø 75

Sealing water height: 50 mm

Drainage capacity: 0.8 l/sec with 20 mm threshold

with removable odour trap

Lateral outlet	Art. no.	Vertical outlet	Art. no.
Ø 50	40 150	Ø 50	40 250
Ø 75	40 170	Ø 75	40 270

without removable odour trap

Lateral outlet	Art. no.	Vertical outlet	Art. no.
Ø 50	40 151	Ø 50	40 251
Ø 75	40 171	Ø 75	40 271

Three lateral inlets Ø 55, one lateral outlet Ø 82

Drainage capacity:

1.8 l/sec with 20 mm threshold

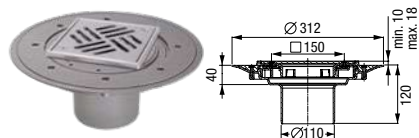
Inclusive: Glue connection

according to BS 5255.

DIN Push fit / DIN glue connection available as accessories (page 207)

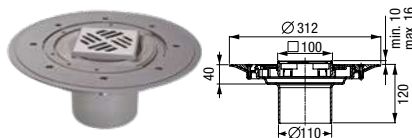
Art. no. 37 3001

Variofix shallow bed upper sections
with covers in stainless steel



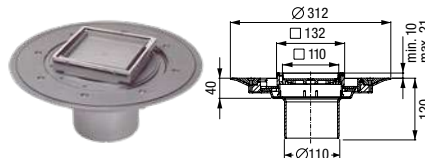
with slotted cover
in stainless steel AISI 304

Material: ABS, rim in stainless steel
Class: K 3
Tile thickness: 8 – 16 mm
Cover: 138×138 mm, screwed
Inclusive: Waterproofing membrane
Art. no. 47 902



with standard slotted cover
in stainless steel AISI 304

Material: ABS
Class: K 3
Tile thickness: 6 – 14 mm
Cover: 95×95 mm
Inclusive: Waterproofing membrane
Art. no. 47 901



with recessed polymer cover
for on-site tiling

Material: ABS, rim in stainless steel AISI 304
Class: K 3
Tile thickness: 10 mm
Cover: 110×110 mm, with locking system
Inclusive: Waterproofing membrane
Art. no. 47 906

Upper sections

with covers in stainless steel and polymer



with tileable cover
made of polymer

Material: ABS,
rim in stainless steel / polymer
Class: K 3
Cover: 110×110 mm
Art. no. 27 211, rim in stainless steel
Art. no. 27 210, rim in polymer



with slotted cover
in stainless steel AISI 304

Material: ABS
Class: K 3
Cover: 100×100 mm
Art. no. 27 165



with closed cover
in stainless steel AISI 304

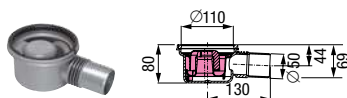
Material: ABS,
rim in stainless steel
Class: L 15
Cover: 150×150 mm, screwed
Inclusive: Gasket
Art. no. 27 1966



with slotted cover
made of polymer

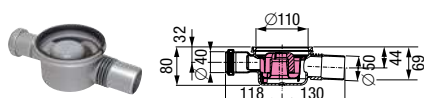
Material: PP, with sealing flange
Class: K 3
Tile thickness: Use with 1 – 4 mm
vinyl / synthetic flooring
Cover: Ø 120 mm
Art. no. 27 192

Drain bodies *The Superflat* in PP
with removable odour trap



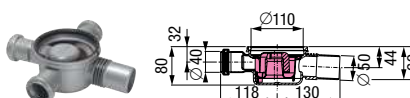
Lateral outlet Ø 50,
without lateral inlet

Sealing water height: 30 mm
Drainage capacity:
0.8 l/sec with 20 mm threshold
Art. no. 42 700



Lateral outlet Ø 50,
one lateral inlet Ø 40

Sealing water height: 30 mm
Drainage capacity:
0.8 l/sec with 20 mm threshold
Art. no. 42 701



Lateral outlet Ø 50,
three lateral inlets Ø 40

Sealing water height: 30 mm
Drainage capacity:
0.8 l/sec with 20 mm threshold
Art. no. 42 703



Accessories

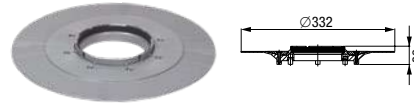
System 100

Classic, The Superflat and Floordrain ME

Glue flange

with counter flange

Compatibility: Also for compound seal; for bathroom drain *Classic*, *The Superflat* and Floordrain ME



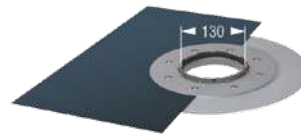
Dimensions
in mm

Art. no.

43 401

with waterproof membrane

Compatibility: For bathroom drain *Classic*, *The Superflat* and Floordrain ME
Inclusive: Pre-mounted waterproof membrane in PVC



1200 × 1200
1800 × 2000

43 401.91

43 401.93

Waterproof membrane

Waterproofing membrane

Compatibility: Art. no. 43 401



Art. no.

48 651

2 component adhesive

Compatibility: For gluing of KESSEL waterproofing membranes



48 650

Elastomer waterproof membrane

in PVC

Compatibility: For bathroom drain *Classic*, *The Superflat* and Floordrain ME
Note: The waterproof membrane in PVC is not suitable for connections to asphalt sheeting.



Dimensions
in mm

Art. no.

500 × 500

43 710

in EPDM

Compatibility: For bathroom drain *Classic*, *The Superflat* and Floordrain ME
Note: The waterproof membrane in EPDM is not suitable for connections to asphalt sheeting.

500 × 500

43 730

Waterproof membrane

Waterproof membrane

Compatibility: For bathroom drain *Classic*, *The Superflat* and Floordrain ME
Material: PVC (without punched-out hole)

Dimensions
in mm

Art. no.

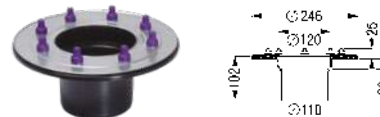
1800 × 2000

43 711

Extension section

in PP

Compatibility: For bathroom drain *Classic*, *The Superflat* and Floordrain ME
Inclusive: Pressure sealing flange in stainless steel AISI 304
Flange width: 63 mm

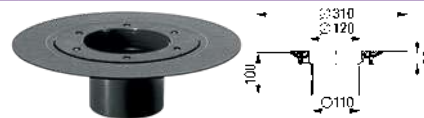


Art. no.

27 198

in ABS

Compatibility: For bathroom drain *Classic*, *The Superflat* and Floordrain ME
Inclusive: Glue flange and counter flange



27 199

in ABS

Compatibility: For bathroom drain *Classic*, *The Superflat* and Floordrain ME
Inclusive: Lip seal



27 146

Accessories

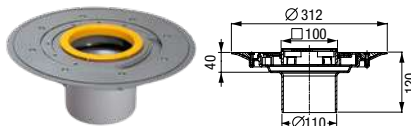
System 100

Classic, The Superflat and Floordrain ME

Intermediate section

with glue flange

Compatibility: Shallow bed gasket; for bathroom drain *Classic, The Superflat* and Floordrain ME
Inclusive: With non-mounted waterproofing membrane according to EN 1253-1 and DIN 18534-1-W3-1



Art. no.

47 900

Hygiene and odour stop

Multistop

Compatibility: For bathroom drain *Classic, The Superflat* and Floordrain ME
Function: Odour, foam, rodent and insect stop



Art. no.

43 500

Hair filter

Compatibility: For bathroom drain *Classic, The Superflat* and Floordrain ME
Material: Polymer



Art. no.

43 700

Sludge trap

Compatibility: For bathroom drain *Classic, The Superflat* and Floordrain ME
Material: Polymer



Art. no.

27 168

Transition section

Transition section

Compatibility: For bathroom drain *Classic* and *The Superflat*
Inclusive: Sealing ring Ø 50



Outer diameter
Ø (mm)

Art. no.

Ø 50/75

27 126

Ø 50/40

27 118

Conversion kit

DIN push-fit connection

Compatibility: For Floordrain ME Art. no. 37 3001
Consist of: 3 inlet adapter Ø 50 mm, 1 outlet adapter Ø 75 mm and 1 push-fit connection for upper section Ø 110, EN 1451-1



Art. no.

37 3008

DIN glue connection

Compatibility: For Floordrain ME Art. no. 37 3001
Consist of: 3 inlet adapter Ø 50 mm, and 1 outlet adapter Ø 75, EN 1451-1



Art. no.

37 3007

Shower channel

Linearis Infinity

The infinitely versatile solution
made of AISI 316L stainless steel

Linearis Infinity 60

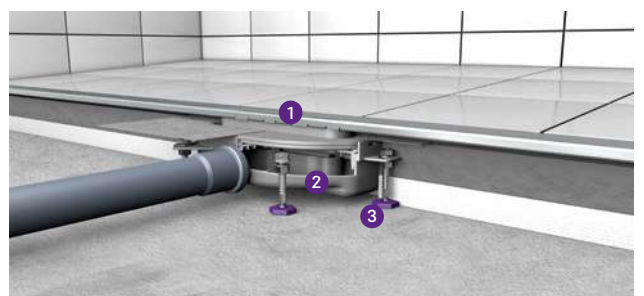
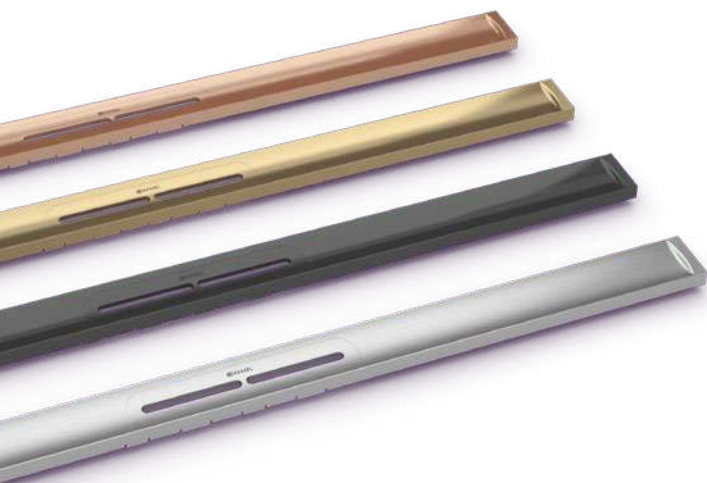
Infinite at last

- min. installation depth 71 mm
- available in 7 different lengths (800 – 1600 mm)
- 4 different cover surfaces to choose from
- flow rate 0.4 – 0.5 l/sec
- with accessories, theoretically infinitely extendable
- 30°, 45°, 90° angles possible
- waterproofing class W3
- incl. sound and settlement absorber
- also available incl. *Megastop*
- incl. factory-mounted waterproofing membrane

Linearis Infinity 90

Infinite at last

- min. installation depth 101 mm
- available in 7 different lengths (800 – 1600 mm)
- 4 different cover surfaces to choose from
- flow rate 0.6 – 0.8 l/sec
- with accessories, theoretically infinitely extendable
- 30°, 45°, 90° angles possible
- waterproofing class W3
- incl. sound and settlement absorber
- incl. factory-mounted waterproofing membrane



① Channel cover ② Drain body ③ Installation supports

Shower channel

Linearis Compact / Linearis Comfort

Linearis shower channels – flush floor

Linearis Compact

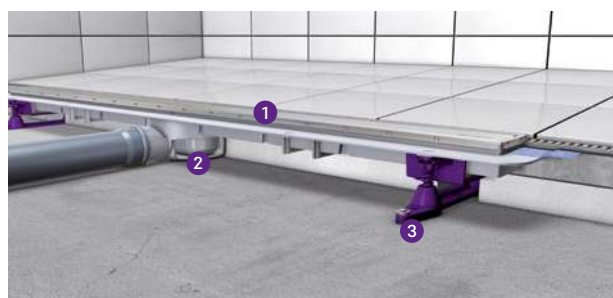
Lowest installation depth

- min. installation depth 80 mm
- available in 9 different lengths (300 – 1150 mm)
- stainless steel cover is reversible for tiling
- flow rate 0.5 – 0.6 l/sec
- up to 15 mm tile build-up
- flange permanently connected to drain body
- incl. (factory-mounted) waterproofing membrane
- waterproofing class W3
- combinable with System 100 drain body

Linearis Comfort

Highest fire protection standards

- available in 5 different lengths (750 – 1150 mm)
- stainless steel cover is reversible for tiling
- flow rate 1.0 – 1.1 l/sec
- fire protection for ceiling penetration
- height-adjustable frame (up to 30 mm) for stone floors
- flange permanently connected to drain body
- incl. factory-mounted waterproofing membrane
- waterproofing class W3
- combinable with System 125 drain body



1 Channel cover 2 Drain body 3 Installation supports



1 Channel cover 2 Drain body 3 Installation supports

Shower channel *Linearis Infinity 60*

with mechanical odour trap *Megastop*

The narrow *Linearis Infinity* channel for walk-in showers is suitable for indoor linear drainage for household and commercial use. The channel profile made of AISI 316 stainless steel can be individually extended straight or at three (30, 45 and 90 degree) angles.

The drain body made of PP is equipped with sound and settlement absorbers. The channel contains a clip-on flange with factory-mounted waterproofing membrane according to EN 1253-1 and DIN 18534-1-W3-I. The channel profile can be pushed in the lengthwise and transverse direction in the clip-on flange to level out construction tolerance. Open seepage water openings, without flooding of the waterproofing level in the event of backwater.

Including *Megastop* mechanical odour trap with water seal.

Version:

Type of waterproofing layer: factory-mounted waterproofing membrane

Seepage opening: open

Water exposure class in accordance to DIN 18534-1 (up to and including): W3-I

Nominal size (Ø): 40 mm

Drain body:

Length: 264 mm

Width: 111 mm

Min. design height: 60 mm

Outlet size (Ø): 40 mm OD, lateral

Material of drain body: PP

Cover features:

Cover material: AISI 316 stainless steel

Min. flooring height: 11 mm

Max. flooring height: 25 mm

Load class: K 3 (EN 1253-1)

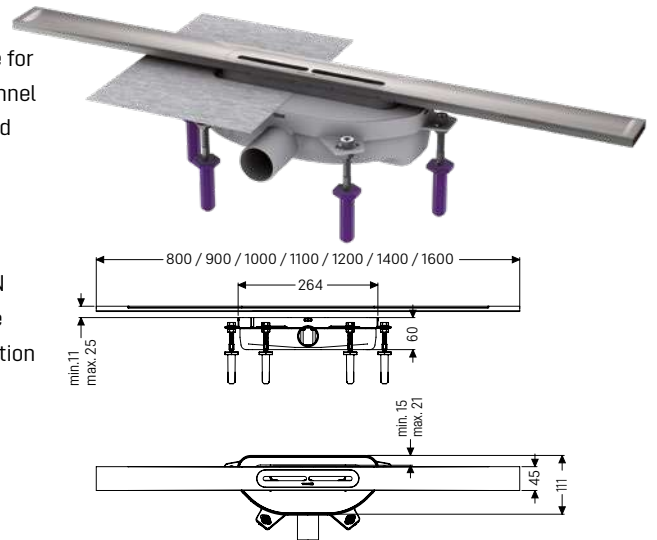
Width: 45 mm

Choose - length, color, odour trap

Discharge rate (l/s) with *Megastop*:

with 10 mm threshold: 0.2 l/s

with 20 mm threshold: 0.4 l/s



Mechanical odour trap *Megastop*

Channel length in mm

Art. no.

Surface: stainless steel, brushed

800	45 300.08
900	45 300.09
1000	45 300.10
1100	45 300.11
1200	45 300.12
1400	45 300.14
1600	45 300.16

Surface: Black, brushed

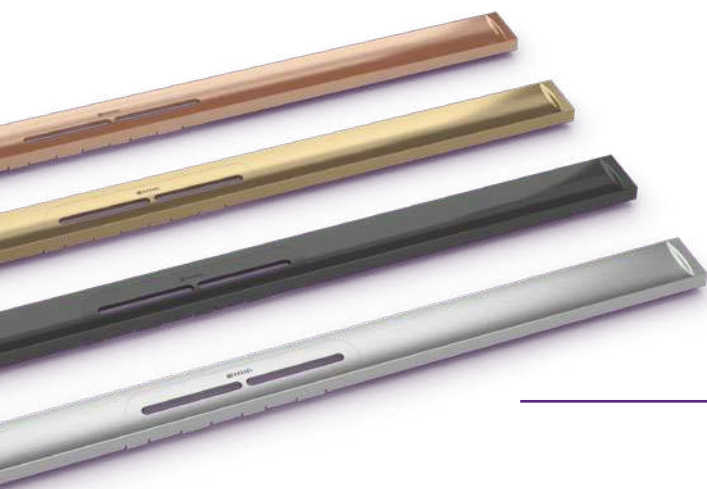
800	45 302.08
900	45 302.09
1000	45 302.10
1100	45 302.11
1200	45 302.12

Surface: Copper, brushed

800	45 303.08
900	45 303.09
1000	45 303.10
1100	45 303.11
1200	45 303.12

Surface: Bronze, brushed

800	45 304.08
900	45 304.09
1000	45 304.10
1100	45 304.11
1200	45 304.12



Shower channel *Linearis Infinity 90*

with odour trap with water sealing height 50 mm

The narrow *Linearis Infinity* channel for walk-in showers is suitable for indoor linear drainage for household and commercial use. The channel profile made of AISI 316 stainless steel can be individually extended straight or at three (30, 45 and 90 degree) angles.

The drain body made of PP is equipped with sound and settlement absorbers. The channel contains a clip-on flange with factory-mounted waterproofing membrane according to EN 1253-1 and DIN 18534-1-W3-I. The channel profile can be pushed in the lengthwise and transverse direction in the clip-on flange to level out construction tolerance. Open seepage water openings, without flooding of the waterproofing level in the event of backwater.

With Odour trap with sealing water height of 50 mm.

Version:

Type of waterproofing layer: factory-mounted waterproofing membrane

Seepage opening: open

Water exposure class in accordance to DIN 18534-1 (up to and including): W3-I

Sealing water height: 50 mm

Nominal size (Ø): 50 mm

Drain body:

Length: 264 mm

Width: 111 mm

Min. design height: 90 mm

Outlet size (Ø): 50 mm OD, lateral

Material of drain body: PP

Cover features:

Cover material: AISI 316 stainless steel

Min. flooring height: 11 mm

Max. flooring height: 25 mm

Load class: K 3 (EN 1253-1)

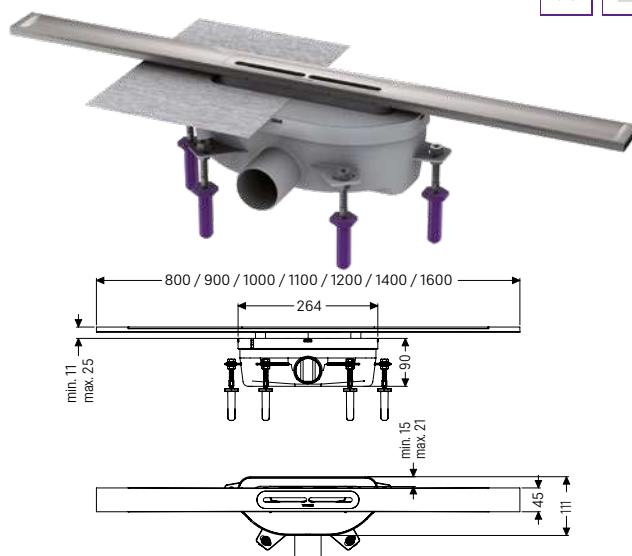
Width: 45 mm

Choose - length, color, odour trap

Discharge rate (l/s):

with 10 mm threshold: 0.6 l/s

with 20 mm threshold: 0.8 l/s



Odour trap with sealing water height 50 mm

Channel length in mm	Art. no.
----------------------	----------

Surface: stainless steel, brushed

800	45 200.08
900	45 200.09
1000	45 200.10
1100	45 200.11
1200	45 200.12
1400	45 200.14
1600	45 200.16

Surface: Black, brushed

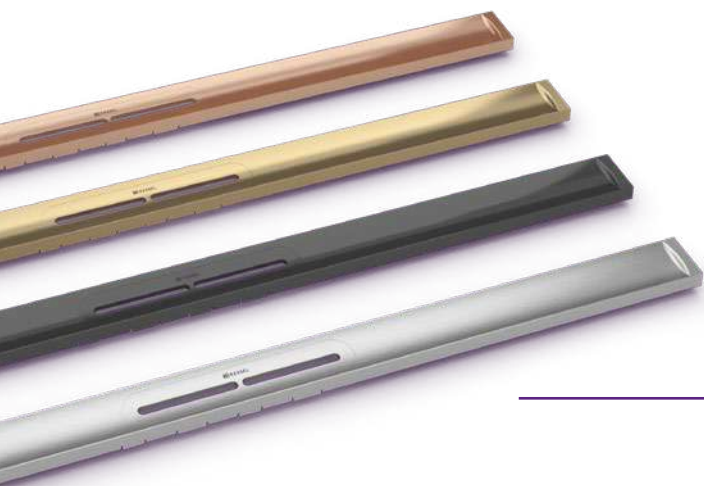
800	45 202.08
900	45 202.09
1000	45 202.10
1100	45 202.11
1200	45 202.12

Surface: Copper, brushed

800	45 203.08
900	45 203.09
1000	45 203.10
1100	45 203.11
1200	45 203.12

Surface: Bronze, brushed

800	45 204.08
900	45 204.09
1000	45 204.10
1100	45 204.11
1200	45 204.12





Accessories

System 125

Linearis Infinity

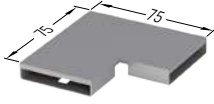
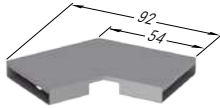
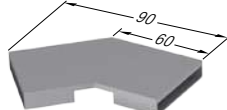
Hygiene and odour stop

			Art. no.
Megastop	Compatibility: For shower channel <i>Linearis Infinity</i> Function: Odour, foam and rodent stop, including hair filter Material: Made of polymer		45 100
Odour trap	Compatibility: For shower channel <i>Linearis Infinity</i> , sealing water height 24 mm Material: Made of polymer		680 941
Hair filter	Compatibility: For <i>Megastop</i> Art. no. 45 100 Material: Made of polymer		45 102

Straight connector

			Art. no.
Straight connector	Compatibility: For shower channel <i>Linearis Infinity</i> Function: Connection of two <i>Infinity</i> channels with another Material: Made of polymer		45 103

Angle connectors

			Surface	Art. no.
90°	Compatibility: For shower channel <i>Linearis Infinity</i> Function: Connection of two <i>Infinity</i> channels at 90 degree angle - includes 2 x Art. no. 45 103 Material: Stainless steel AISI 304		Stainless steel, brushed	45 100.01
			Black, brushed	45 102.01
			Copper, brushed	45 103.01
			Bronze, brushed	45 104.01
45°	Compatibility: For shower channel <i>Linearis Infinity</i> Function: Connection of two <i>Infinity</i> channels at 45 degree angle - includes 2 x Art. no. 45 103 Material: Stainless steel AISI 304		Stainless steel, brushed	45 100.02
			Black, brushed	45 102.02
			Copper, brushed	45 103.02
			Bronze, brushed	45 104.02
30°	Compatibility: For shower channel <i>Linearis Infinity</i> Function: Connection of two <i>Infinity</i> channels at 30 degree angle - includes 2 x Art. no. 45 103 Material: Stainless steel AISI 304		Stainless steel, brushed	45 100.03
			Black, brushed	45 102.03
			Copper, brushed	45 103.03
			Bronze, brushed	45 104.03



Shower channel *Linearis Compact*

with cover and rim in stainless steel AISI 304

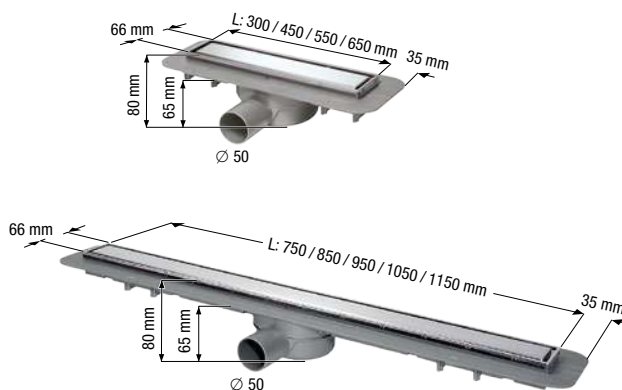


Made in ABS. With lateral outlet Ø 50, installation depth only 80 mm, removable odour trap, installation supports and with factory-mounted waterproofing membrane according to EN 1253-1 and DIN 18534-1-W3-I.

Drainage capacity 0.6 l/sec / 0.7 l/sec with 10 mm / without threshold. Sealing water height 22 mm

Cover:

Cover and rim in stainless steel AISI 304 (Channel cover can be reversed and tiled on site), for tile thickness 15 mm, class K 3, seeping water openings prepared



➤ *Linearis Compact* upper sections for combination with individual system 100 drain bodies: page 220

Channel length in mm	Art. no.
With factory-mounted waterproofing membrane	
300	45 600.59M
450	45 600.60M
550	45 600.61M
650	45 600.62M
750	45 600.63M
850	45 600.64M
950	45 600.65M
1050	45 600.66M
1150	45 600.67M



Shower channel upper section *Linearis Compact*

System 100

with cover and rim in stainless steel AISI 304

Made in ABS. With removable odour trap (remove from all drain bodies during installation), installation supports and waterproofing membrane.

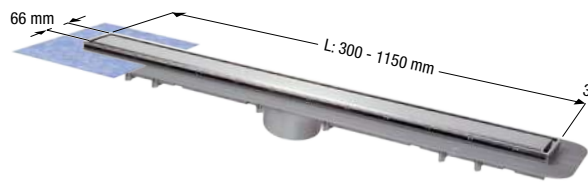
Drainage capacity 0.6 l/sec with 10 mm threshold.

Sealing water height 50 mm

Cover:

Cover and rim in stainless steel AISI 304 (Channel cover can be reversed and tiled on site), for tile thickness 15 mm, class K 3, seeping water openings prepared

Note: Drain bodies system 100 see page below



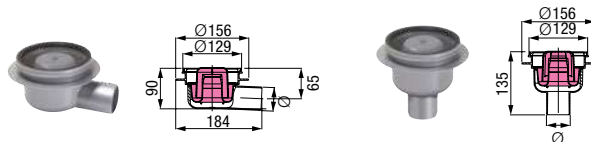
Channel length in mm	Art. no.
300	47 804S
450	47 805S
550	47 806S
650	47 807S
750	47 808S
850	47 809S
950	47 810S
1050	47 811S
1150	47 812S

Accessories

Linearis Compact

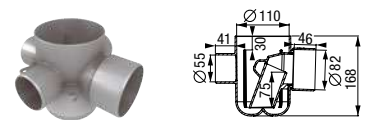
Drain bodies *Classic* in ABS

with / without removable odour trap



Drain body *Floordrain ME* in ABS

with removable odour trap



Lateral outlet / Vertical outlet Ø 50 / Ø 75

Sealing water height: 50 mm

Drainage capacity: 0.8 l/sec with 20 mm threshold

with removable odour trap

Lateral outlet	Art. no.	Vertical outlet	Art. no.
Ø 50	40 150	Ø 50	40 250
Ø 75	40 170	Ø 75	40 270

without removable odour trap

Lateral outlet	Art. no.	Vertical outlet	Art. no.
Ø 50	40 151	Ø 50	40 251
Ø 75	40 171	Ø 75	40 271

Three lateral inlets Ø 55, one lateral outlet Ø 82

Drainage capacity:

1.8 l/sec with 20 mm threshold

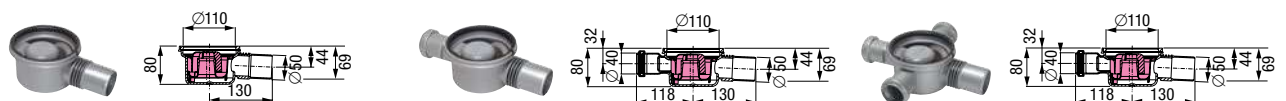
Inclusive: Glue connection according to BS 5255.

DIN Push fit / DIN glue connection available as accessories (page 207)

Art. no. 37 3001

Drain bodies *The Superflat* in PP

with removable odour trap



Lateral outlet Ø 50, without lateral inlet

Sealing water height: 30 mm

Drainage capacity:

0.8 l/sec with 20 mm threshold

Art. no. 42 700

Lateral outlet Ø 50, one lateral inlet Ø 40

Sealing water height: 30 mm

Drainage capacity:

0.8 l/sec with 20 mm threshold

Art. no. 42 701

Lateral outlet Ø 50, three lateral inlets Ø 40

Sealing water height: 30 mm

Drainage capacity:

0.8 l/sec with 20 mm threshold

Art. no. 42 703

Shower channel upper section *Linearis Comfort*

System 125

with cover and rim in stainless steel AISI 304

Made in ABS

Minimum installation height of upper section excl. drain body 46 mm, with removable odour trap, installation supports and with factory-mounted waterproofing membrane according to EN 1253-1 and DIN 18534-1-W3-1.

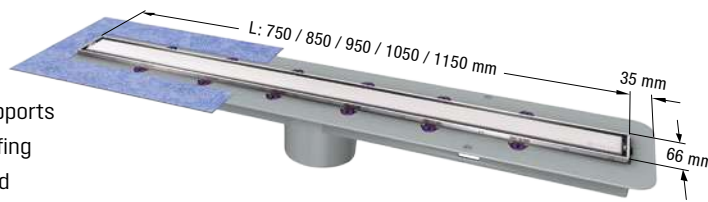
Drainage capacity 1.1 l/sec / 1.1 l/sec with 10 mm / without threshold.

Sealing water height 50 mm

Cover:

Cover and rim in stainless steel AISI 304 (Channel cover can be reversed and tiled on site), for tile thickness 7 – 22 mm, class K 3, with seeping water opening

Note: Drain bodies see page below; also in combination with drain bodies *Ferrofix* system 125



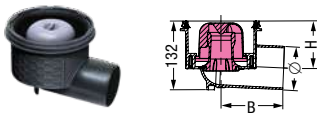
Channel length in mm	Art. no.
With factory-mounted waterproofing membrane	
750	48 928M
850	48 929M
950	48 930M
1050	48 931M
1150	48 932M

Accessories

Linearis Comfort

Drain bodies *Ecoguss* / *Practicus*

with removable odour trap*

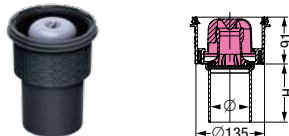


Ecoguss with connection flange lateral outlet

Material: *Ecoguss*

Sealing water height: 50 mm

Ø 58	B × H 245 × 120 mm	Art. no. 48 358
Ø 78	B × H 134 × 109 mm	Art. no. 48 378
Ø 83	B × H 134 × 108 mm	Art. no. 48 383
Ø 110	B × H 148 × 92 mm	Art. no. 48 311

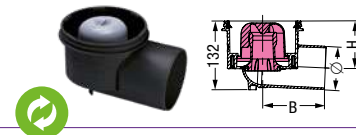


Ecoguss with connection flange vertical outlet

Material: *Ecoguss*

Sealing water height: 50 mm

Ø 58	H 100 mm	Art. no. 48 458
Ø 78	H 110 mm	Art. no. 48 478
Ø 83	H 110 mm	Art. no. 48 483
Ø 110	H 110 mm	Art. no. 48 411

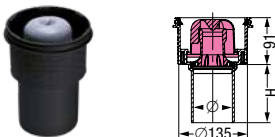


Practicus with connection flange lateral outlet

Material: PP

Sealing water height: 50 mm

Ø 50	B × H 245 × 120 mm	Art. no. 45 150
Ø 75	B × H 134 × 109 mm	Art. no. 45 170
Ø 110	B × H 148 × 92 mm	Art. no. 45 110



Practicus with connection flange vertical outlet

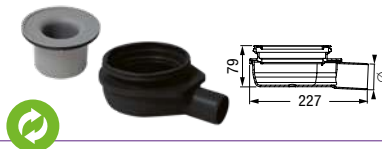
Material: PP

Sealing water height: 50 mm

Ø 50	H 100 mm	Art. no. 45 250
Ø 75	H 110 mm	Art. no. 45 270
Ø 110	H 110 mm	Art. no. 45 210

Drain body *The Ultraflat 79*

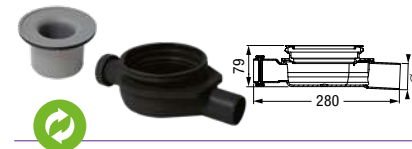
with non-mounted odour trap for installation in an upper section



Lateral outlet Ø 50 without inlet

Sealing water height: 50 mm

Ø 50	Art. no. 44 700
------	-----------------



Lateral outlet Ø 50 with inlet Ø 40

Sealing water height: 50 mm

Ø 50	Art. no. 44 701
------	-----------------

*The *Linearis Comfort* and *Linearis Compact* shower channels already include an odour trap. For this reason, the odour trap must be removed from all drain bodies during installation.

Accessories

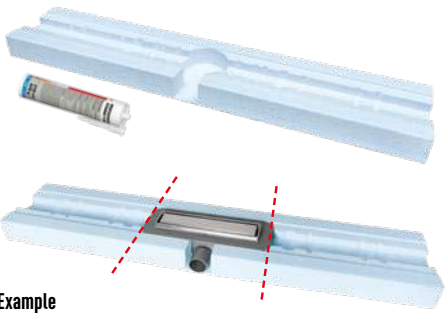
System 125

Linearis Comfort and Linearis Compact

Hygiene and odour stop

			Art. no.
Multistop	Compatibility: For shower channel <i>Linearis Compact</i> Function: Odour, foam, rodent and insect stop		48 400
Hair filter	Compatibility: For shower channel <i>Linearis Compact</i> Material: Made of polymer		48 800

Installation aid





			Art. no.
Linearis Comfort	Compatibility: Suitable for all channel lengths from 750 to 1150 mm, can be shortened on-site Function: Replaces the screed underlining Inclusive: Mounting adhesive		48 640
Linearis Compact	Compatibility: Suitable for all channel lengths from 300 to 1150 mm, can be shortened on-site Function: Replaces the screed underlining Inclusive: Mounting adhesive		48 639

Sound protection elements

			Art. no.
Sound protection elements	Compatibility: For installation supports shower channel <i>Linearis Compact</i> Version: H = 10 mm Note: Increases the minimal installation height from 80 mm to 90 mm		48 630

Flanges

can be combined with drain bodies *Ecoguss, Practicus* and *The Ultraflat 79*

			Dimensions in mm	Art. no.
Clip flange	Inclusive: Factory-mounted waterproofing membrane in accordance with EN 1253-1 and DIN 18534-1-W3-1		280x280	44 703
Glue flange with counter flange	Material: ABS Compatibility: Also for compound seal		Ø 348	48 410
without connection flange	Material: ABS		Ø 268	48 409
Pressure sealing flange	Material: Stainless steel AISI 304 Inclusive: Seeping water opening		Ø 273	48 407

Wall drain *Scada*

The award-winning drain for high end bathrooms.

The design prize-winning, wall drain *Scada* is not only set into the floor, but also into the wall, creating a 100% level access, walk-in shower area. Thanks to its minimum installation depth of only 80 mm to the top of the tile, the *Scada* is also ideally suited for renovation projects.

There is a choice of four high-grade drain covers available for *Scada* – even including versions with LED lighting. If necessary, the wall drain can also be pre-assembled and delivered sealed in an installation board. Combined with the shower board with integrated drainage slope, this model is ideal for drywall construction.



1 Wall drain *Scada* 2 Height-adjustable installation supports

Pre-assembled and sealed complete solution

The *Scada* wall drain is available as a pre-assembled and sealed complete solution for easy installation. It is made up of an installation board including drain and a shower board with integrated drainage slope.

Maximum accessibility

As the *Scada* is set into the wall, the floor of the shower area remains completely untouched – accessibility at its finest.

Factory-mounted waterproofing membrane

The *Scada* is supplied with a factory-mounted waterproofing membrane, which fulfils the highest water action class W3 to DIN 18534-1. It is therefore fully suitable for commercial use.



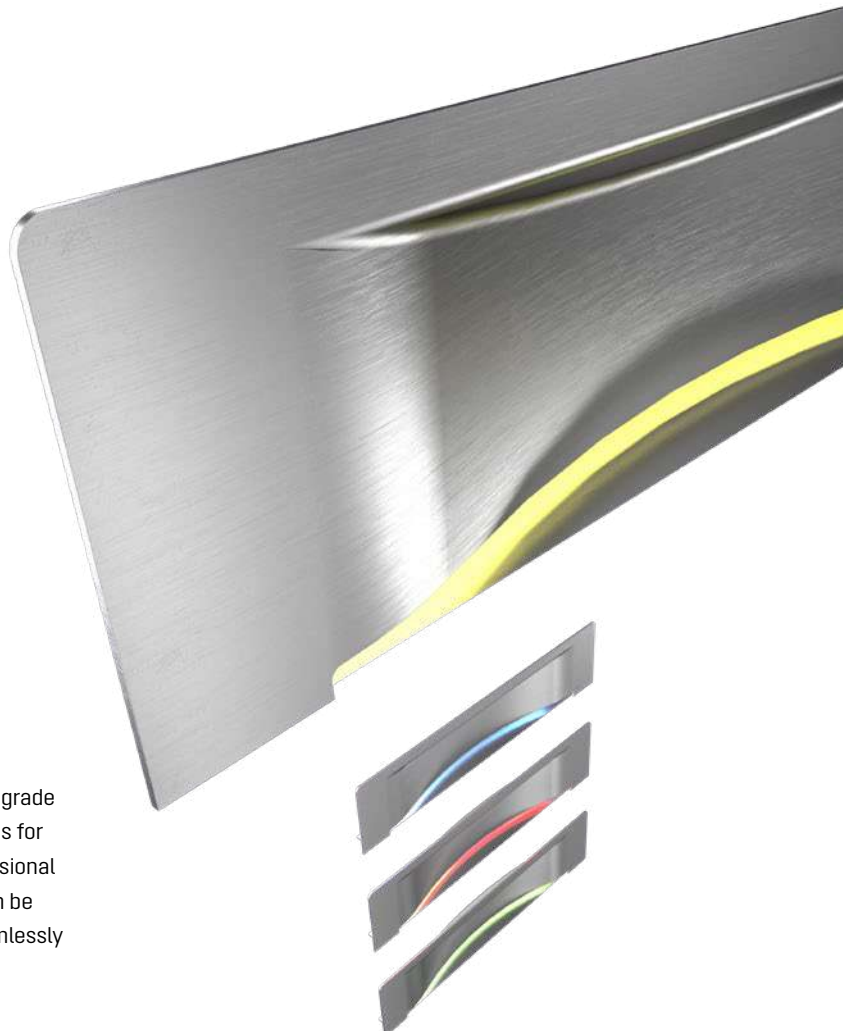
Height-adjustable installation supports

Continuously height-adjustable installation supports enable convenient adjustment of the overall installation height from 80 to 215mm up to the top of the tile, as well as distances from the wall from 100 to 180 mm. Thanks to triple outlet connection options (front, lateral left or right), it is not necessary to move the drain pipe on site and underfloor heating can be easily laid.



Award-winning design

We provide four different drain covers made of V2A grade stainless steel to choose from: two smooth versions for different tile thicknesses, one cover in three-dimensional wave look as well as the “invisible” cover, which can be individually tiled and is thus integrated almost seamlessly into the wall of the shower area.



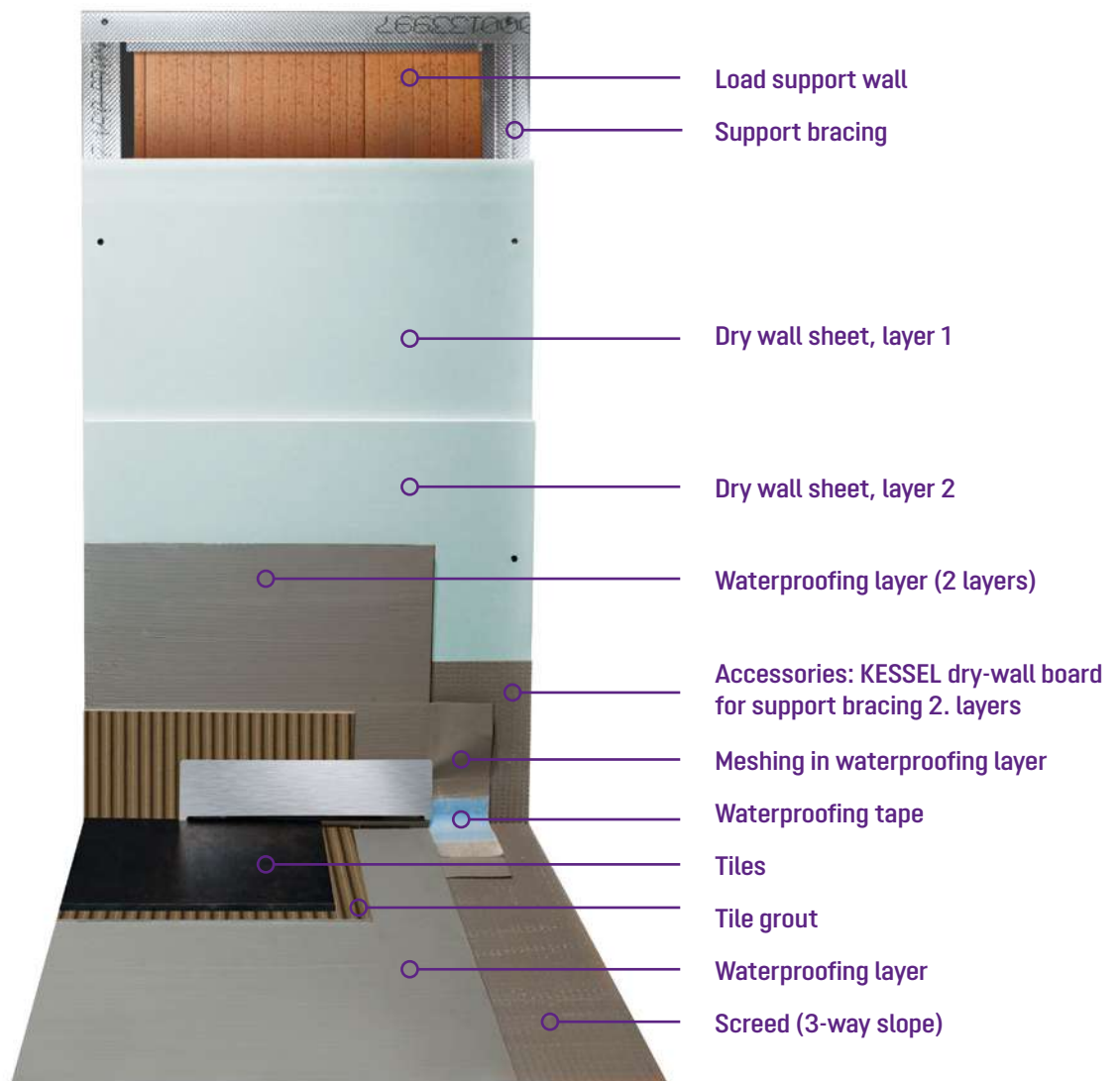
Installation options

Scada

Flexibility for fitters

The professionally engineered Scada wall drain is designed for multiple installation methods – the system is perfectly designed for a quick on-site installation.

Installation in dry-wall constructions



Installation in brick wall constructions



Scada without LED-backlighting

System 125



Matrix order system

Drain body

Wall drain Scada

For floor drainage indoors
 With odour trap and flange
 for alternative sealing.
 Drainage capacity 0.5 l/sec flow rate
 Sealing water height 22 mm
 Drain body in ABS,
 lateral outlet Ø 50, with factory-
 mounted waterproofing membrane.
 Connection option at the front,
 on the left side or right side.

Covers

Cover Scada in stainless steel AISI 304

Invisible

with stainless steel
 frame AISI 304
 Width × height
 296 × 61 mm
 For floor tiles up
 to 10 mm, can be
 tiled with wall tiles
 up to 10 mm

Width × height
 312 × 74 mm
 For floor tiles
 up to 10 mm

Wave

Width × height
 312 × 74 mm
 For floor tiles
 up to 10 mm

Width × height
 312 × 67 mm
 For floor tiles
 up to 17 mm

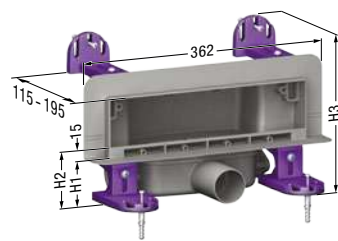


Art. no. 48 011

Art. no. 48 012

Art. no. 48 013

Art. no. 48 014



H1 = Upper edge flange 65 - 200 mm
 H2 = Upper edge tile 80 - 215 mm
 H3 = Overall height 218 - 353 mm
 (incl. installation supports)

Item comprised of drain body Scada and drain cover

Art. no. 48 000M

Art. no. 48 000.01M

Art. no. 48 000.02M

Art. no. 48 000.03M

Art. no. 48 000.04M

Accessories

System 125

Scada

Drywall mount

Height × width
 in mm

Art. no.

Drywall mount

Compatibility: For drain body Scada
Inclusive: Adhesive



300 × 623

48 063

Scada with LED-backlighting



Matrix order system

Drain body

Wall drain Scada
with LED-backlighting,
color of choice
For floor drainage indoors
With odour trap and flange
for alternative sealing.
Drainage capacity 0.5 l/sec flow rate
Sealing water height 22 mm
Drain body in ABS,
lateral outlet Ø 50, with factory-
mounted waterproofing membrane.
Connection option at the front,
on the left side or right side.

Covers

Cover Scada in stainless steel AISI 304

Invisible

with stainless steel
frame AISI 304
Width × height
296 × 61 mm
For floor tiles up
to 10 mm, can be
tiled with wall tiles
up to 10 mm

Width × height
312 × 74 mm
For floor tiles
up to 10 mm

Wave

Width × height
312 × 74 mm
For floor tiles
up to 10 mm

Width × height
312 × 67 mm
For floor tiles
up to 17 mm

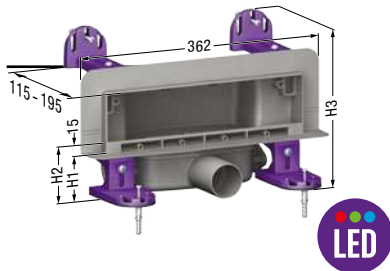


Art. no. 48 011

Art. no. 48 012

Art. no. 48 013

Art. no. 48 014



H1 = Upper edge flange 65 - 200 mm
H2 = Upper edge tile 80 - 215 mm
H3 = Overall height 218 - 353 mm
(incl. installation supports)

Item comprised of drain body Scada and drain cover

Art. no. 48 003M

Art. no. 48 003.41M

Art. no. 48 003.42M

Art. no. 48 003.43M

Art. no. 48 003.44M

System 125

Hygiene and odour stop

Art. no.

Multistop

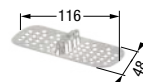
Compatibility: For wall drain Scada
Function: Odour, foam, rodent and insect stop



48 400

Hair filter

Compatibility: For wall drain Scada
Material: Polymer



48 800



4.2 Floor drains

Floor drains with versatile properties



Floor drain *Ecoguss* made in metallic polymer compound

The innovative solution for industrial applications.

An innovation, which sets standards: For our floor / roof drain *Ecoguss* we use the custom developed composite material of the same name, which combines the specific advantages of polymer and metal. The *Ecoguss* is therefore an economic and easy to install alternative to drains made of cast iron. At the same time, it offers advantages with regard to hygiene as well as fire protection and sound insulation and is therefore particularly suitable for public buildings such as hotels, hospitals or swimming pools.



- 1 Drainbody *Ecoguss*
- 2 *Variofix* upper section with shallow waterproofing flange



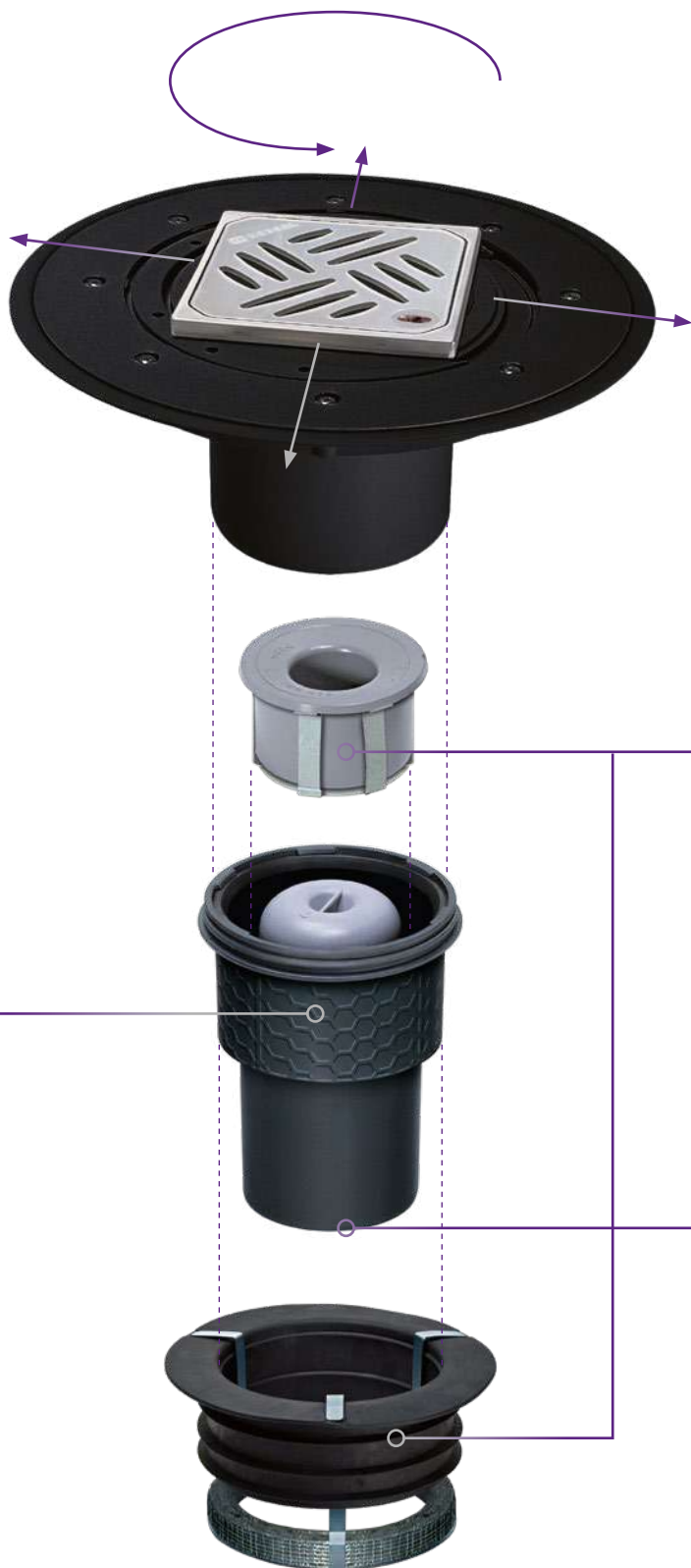
The best of both worlds:

Project drains made of *Ecoguss*

Resistance, convenience, cleanliness – all these are offered by *Ecoguss* – our high-tech composite. It is three times lighter than cast iron and at the same time it is temperature resistant as well as being highly resistant to chemical exposure and mechanical loads. In addition, *Ecoguss* does not corrode (rust) and is extremely hygienic – thanks to its smooth, coating-free surface. *Ecoguss* drains can be installed without time-consuming electrical grounding work and are also suitable for connection to SML (flanged) pipes.

Find out more about the material:

- *Ecoguss* resistant: page 191
- *Ecoguss* heavy duty: pages 191



Variable upper sections

Extremely flexible: our rotatable, tiltable and height-adjustable upper sections. The shallow bed *Variofix* upper section also allows the cover to be moved and thus adapted to the tile pattern.

Highest fire protection standards

Fire-Kit and Quick-Fit

➤ Fire protection: page 247

Outlet diameter

- DN 50: Ø 58 mm
- DN 70: Ø 78 mm
- DN 80: Ø 83 mm
- DN 100: Ø 110 mm

With our modular system 125, we provide numerous possible combinations for our project drains.

- Upper sections: page 244
- Drain body: page 244
- Further accessories: page 246

Ecoguss with pressure sealing flange

Matrix order system

System 125



EN 1253-1

Drain body

Ecoguss resistant

with pressure sealing flange

for connection to SML-pipe, with odour trap.

Drainage capacity in l/sec with 20 mm / 10 mm threshold see table.

Sealing water height 50 mm

➤ Modular system

see pages 244 – 245

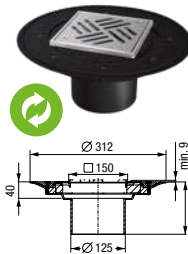
Upper sections

Shallow bed upper section in ABS

with included waterproofing membrane

Slotted cover

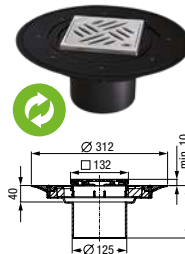
138 × 138 mm and rim in stainless steel AISI 304, class K 3, screwed



Art. no. 48 963

Design cover Kessel

120 × 120 mm and rim in stainless steel AISI 304, class L 15, Lock & Lift locking system

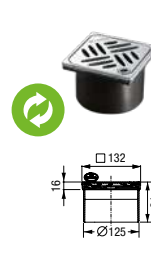


Art. no. 48 904

Upper section in ABS

Design cover Kessel

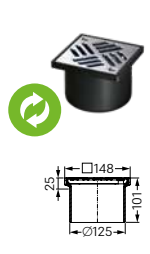
120 × 120 mm and rim in stainless steel AISI 304, class L 15, Lock & Lift locking system



Art. no. 48 201

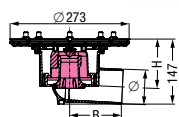
Slotted cover

138 × 138 mm in stainless steel AISI 304, class K 3, screwed



Art. no. 48 950

Drain body with lateral outlet



Ø	H	B
58	120	245
78	109	134
83	108	134
110	92	148

Ø 58 Art. no. 48 758

Ø 78 Art. no. 48 778

Ø 83 Art. no. 48 783

Ø 110 Art. no. 48 711

Complete drain comprising a combination of the upper section and drain body

Art. no. 48 758.51

Drainage capacity* 1.6 / 1.2

Art. no. 48 758.53

Drainage capacity* 1.6 / 1.2

Art. no. 48 758.63

Drainage capacity* 1.4 / 1.0

Art. no. 48 758.11

Drainage capacity* 1.4 / 1.0

Art. no. 48 778.51

Drainage capacity* 1.5 / 1.2

Art. no. 48 778.53

Drainage capacity* 1.5 / 1.2

Art. no. 48 778.63

Drainage capacity* 1.3 / 1.1

Art. no. 48 778.11

Drainage capacity* 1.3 / 1.1

Art. no. 48 783.51

Drainage capacity* 1.6 / 1.2

Art. no. 48 783.53

Drainage capacity* 1.6 / 1.2

Art. no. 48 783.63

Drainage capacity* 1.4 / 1.1

Art. no. 48 783.11

Drainage capacity* 1.4 / 1.1

Art. no. 48 711.51

Drainage capacity* 1.7 / 1.0

Art. no. 48 711.53

Drainage capacity* 1.7 / 1.0

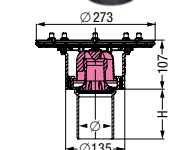
Art. no. 48 711.63

Drainage capacity* 1.5 / 1.0

Art. no. 48 711.11

Drainage capacity* 1.6 / 1.0

Drain body with vertical outlet



Ø	H
58	100
78	110
83	110
110	110

Ø 58 Art. no. 48 858

Ø 78 Art. no. 48 878

Ø 83 Art. no. 48 883

Ø 110 Art. no. 48 811

Complete drain comprising a combination of the upper section and drain body

Art. no. 48 858.51

Drainage capacity* 2.1 / 1.3

Art. no. 48 858.53

Drainage capacity* 2.1 / 1.3

Art. no. 48 858.63

Drainage capacity* 1.9 / 1.0

Art. no. 48 858.11

Drainage capacity* 1.9 / 1.0

Art. no. 48 878.51

Drainage capacity* 2.1 / 1.0

Art. no. 48 878.53

Drainage capacity* 2.1 / 1.0

Art. no. 48 878.63

Drainage capacity* 1.9 / 1.0

Art. no. 48 878.11

Drainage capacity* 1.9 / 1.0

Art. no. 48 883.51

Drainage capacity* 2.1 / 1.0

Art. no. 48 883.53

Drainage capacity* 2.1 / 1.0

Art. no. 48 883.63

Drainage capacity* 1.9 / 1.0

Art. no. 48 883.11

Drainage capacity* 1.9 / 1.0

Art. no. 48 811.51

Drainage capacity* 2.1 / 1.0

Art. no. 48 811.53

Drainage capacity* 2.1 / 1.0

Art. no. 48 811.63

Drainage capacity* 1.9 / 1.0

Art. no. 48 811.11

Drainage capacity* 2.0 / 1.0

* Drainage capacity in l/sec with 20 mm / 10 mm threshold see table

Ecoguss with glue flange

Matrix order system

System 125



Drain body

Ecoguss resistant with glue flange

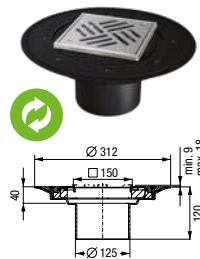
for connection to SML-pipe, with odour trap.
 Drainage capacity in l/sec with 20 mm / 10 mm threshold see table.
 Sealing water height 50 mm

➤ **Modular system**
 see pages 244 – 245

Upper sections

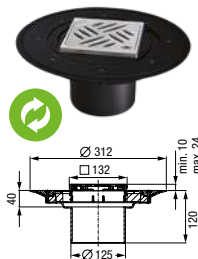
Shallow bed upper section in ABS
 with included waterproofing membrane

Slotted cover
 138×138 mm and rim in stainless steel AISI 304, class K 3, screwed



Art. no. 48 963

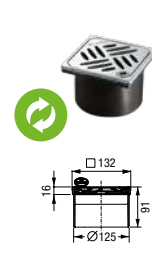
Design cover Kessel
 120×120 mm and rim in stainless steel AISI 304, class L 15, Lock & Lift locking system



Art. no. 48 904

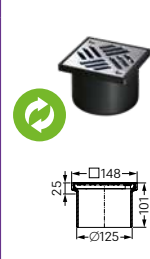
Upper section in ABS

Design cover Kessel
 120×120 mm and rim in stainless steel AISI 304, class L 15, Lock & Lift locking system



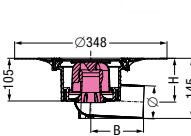
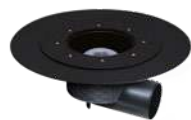
Art. no. 48 201

Slotted cover
 138×138 mm in stainless steel AISI 304, class K 3, screwed



Art. no. 48 950

Drain body with lateral outlet



Ø	H	B
58	120	245
78	107	134
83	106	134
110	90	148

Ø 58 Art. no. 48 558

Ø 78 Art. no. 48 578

Ø 83 Art. no. 48 583

Ø 110 Art. no. 48 511

Complete drain comprising a combination of the upper section and drain body

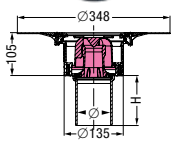
Art. no.	48 558.51	Art. no.	48 558.53	Art. no.	48 558.63	Art. no.	48 558.11
Drainage capacity*	1.6 / 1.3	Drainage capacity*	1.5 / 1.2	Drainage capacity*	1.4 / 1.0	Drainage capacity*	1.4 / 1.0

Art. no.	48 578.51	Art. no.	48 578.53	Art. no.	48 578.63	Art. no.	48 578.11
Drainage capacity*	1.6 / 1.2	Drainage capacity*	1.5 / 1.2	Drainage capacity*	1.4 / 1.1	Drainage capacity*	1.4 / 1.1

Art. no.	48 583.51	Art. no.	48 583.53	Art. no.	48 583.63	Art. no.	48 583.11
Drainage capacity*	1.6 / 1.2	Drainage capacity*	1.5 / 1.2	Drainage capacity*	1.4 / 1.1	Drainage capacity*	1.4 / 1.1

Art. no.	48 511.51	Art. no.	48 511.53	Art. no.	48 511.63	Art. no.	48 511.11
Drainage capacity*	1.8 / 1.0	Drainage capacity*	1.8 / 1.0	Drainage capacity*	1.6 / 1.0	Drainage capacity*	1.6 / 1.0

Drain body with vertical outlet



Ø	H
58	100
78	110
83	110
110	110

Ø 58 Art. no. 48 658

Ø 78 Art. no. 48 678

Ø 83 Art. no. 48 683

Ø 110 Art. no. 48 611

Complete drain comprising a combination of the upper section and drain body

Art. no.	48 658.51	Art. no.	48 658.53	Art. no.	48 658.63	Art. no.	48 658.11
Drainage capacity*	2.2 / 1.3	Drainage capacity*	2.2 / 1.3	Drainage capacity*	2.0 / 1.0	Drainage capacity*	2.0 / 1.0

Art. no.	48 678.51	Art. no.	48 678.53	Art. no.	48 678.63	Art. no.	48 678.11
Drainage capacity*	2.1 / 1.0	Drainage capacity*	2.1 / 1.0	Drainage capacity*	2.0 / 1.0	Drainage capacity*	2.0 / 1.0

Art. no.	48 683.51	Art. no.	48 683.53	Art. no.	48 683.63	Art. no.	48 683.11
Drainage capacity*	2.1 / 1.0	Drainage capacity*	2.1 / 1.0	Drainage capacity*	2.0 / 1.0	Drainage capacity*	2.0 / 1.0

Art. no.	48 611.51	Art. no.	48 611.53	Art. no.	48 611.63	Art. no.	48 611.11
Drainage capacity*	2.2 / 1.0	Drainage capacity*	2.2 / 1.0	Drainage capacity*	2.0 / 1.0	Drainage capacity*	2.0 / 1.0

* Drainage capacity in l/sec with 20 mm / 10 mm threshold see table

Ecoguss with connection flange

Matrix order system



Drain body

Ecoguss resistant with connection flange

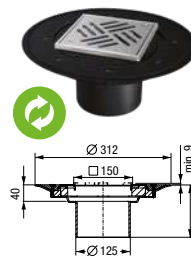
for connection to SML-pipe, with odour trap.
 Drainage capacity in l/sec with 20 mm / 10 mm threshold see table.
 Sealing water height 50 mm

➤ **Modular system**
 see pages 244 – 245

Upper sections

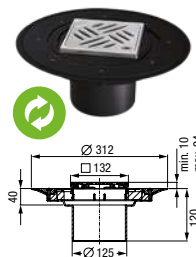
Shallow bed upper section in ABS with included waterproofing membrane

Slotted cover
 138 × 138 mm and rim in stainless steel AISI 304, class K 3, screwed



Art. no. 48 963

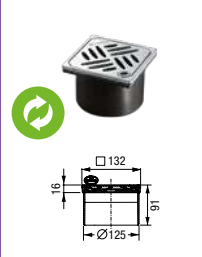
Design cover Kessel
 120 × 120 mm and rim in stainless steel AISI 304, class L 15, Lock & Lift locking system



Art. no. 48 904

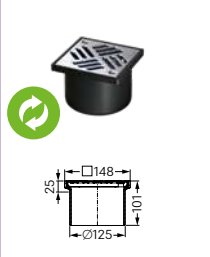
Upper section in ABS

Design cover Kessel
 120 × 120 mm and rim in stainless steel AISI 304, class L 15, Lock & Lift locking system



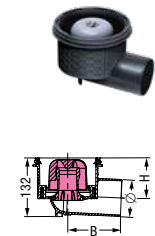
Art. no. 48 201

Slotted cover
 138 × 138 mm in stainless steel AISI 304, class K 3, screwed



Art. no. 48 950

Drain body with lateral outlet

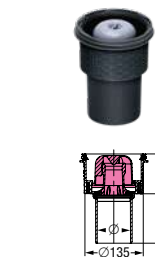


Ø	H	B
58	120	245
78	109	134
83	108	134
110	92	148

Complete drain comprising a combination of the upper section and drain body

Ø	Art. no.	Art. no.	Art. no.	Art. no.	Art. no.
Ø 58	Art. no. 48 358	Art. no. 48 358.51	Art. no. 48 358.53	Art. no. 48 358.63	Art. no. 48 358.11
		Drainage capacity* 1.6 / 1.3	Drainage capacity* 1.5 / 1.2	Drainage capacity* 1.4 / 1.0	Drainage capacity* 1.4 / 1.0
Ø 78	Art. no. 48 378	Art. no. 48 378.51	Art. no. 48 378.53	Art. no. 48 378.63	Art. no. 48 378.11
		Drainage capacity* 1.6 / 1.2	Drainage capacity* 1.5 / 1.2	Drainage capacity* 1.4 / 1.1	Drainage capacity* 1.4 / 1.1
Ø 83	Art. no. 48 383	Art. no. 48 383.51	Art. no. 48 383.53	Art. no. 48 383.63	Art. no. 48 383.11
		Drainage capacity* 1.6 / 1.2	Drainage capacity* 1.5 / 1.2	Drainage capacity* 1.4 / 1.1	Drainage capacity* 1.4 / 1.1
Ø 110	Art. no. 48 311	Art. no. 48 311.51	Art. no. 48 311.53	Art. no. 48 311.63	Art. no. 48 311.11
		Drainage capacity* 1.7 / 1.2	Drainage capacity* 1.6 / 1.0	Drainage capacity* 1.5 / 1.2	Drainage capacity* 1.6 / 1.1

Drain body with vertical outlet



Ø	H
58	100
78	110
83	110
110	110

Complete drain comprising a combination of the upper section and drain body

Ø	Art. no.	Art. no.	Art. no.	Art. no.	Art. no.
Ø 58	Art. no. 48 458	Art. no. 48 458.51	Art. no. 48 458.53	Art. no. 48 458.63	Art. no. 48 458.11
		Drainage capacity* 2.2 / 1.3	Drainage capacity* 2.2 / 1.3	Drainage capacity* 2.0 / 1.0	Drainage capacity* 2.0 / 1.0
Ø 78	Art. no. 48 478	Art. no. 48 478.51	Art. no. 48 478.53	Art. no. 48 478.63	Art. no. 48 478.11
		Drainage capacity* 2.1 / 1.0	Drainage capacity* 2.1 / 1.0	Drainage capacity* 2.0 / 1.0	Drainage capacity* 2.0 / 1.0
Ø 83	Art. no. 48 483	Art. no. 48 483.51	Art. no. 48 483.53	Art. no. 48 483.63	Art. no. 48 483.11
		Drainage capacity* 2.1 / 1.0	Drainage capacity* 2.1 / 1.0	Drainage capacity* 2.0 / 1.0	Drainage capacity* 2.0 / 1.0
Ø 110	Art. no. 48 411	Art. no. 48 411.51	Art. no. 48 411.53	Art. no. 48 411.63	Art. no. 48 411.11
		Drainage capacity* 2.2 / 1.0	Drainage capacity* 2.2 / 1.0	Drainage capacity* 2.0 / 1.0	Drainage capacity* 2.0 / 1.0

* Drainage capacity in l/sec with 20 mm / 10 mm threshold see table

Floor/Roof drain *Ecoguss*

with *Variofix* shallow bed upper section and slotted cover in stainless steel AISI 304

System 125



EN 1253-1

Made in *Ecoguss resistant*, for connection to SML-pipe according to DIN 19522, with removable odour trap, vertical outlet, with lip seal. With enclosed waterproofing membrane (articles with *Variofix* shallow bed upper section)

Drainage capacity in l/sec with 20 mm / 10 mm threshold

- Ø 58: 2.2 l/sec / 1.3 l/sec
- Ø 78: 2.1 l/sec / 1.0 l/sec
- Ø 110: 2.2 l/sec / 1.0 l/sec

Sealing water height 50 mm.

Installation area 180×180 mm

With upper section in ABS

Cover:

Rim in stainless steel AISI 304 (articles with *Variofix* shallow bed upper section)

or ABS, slotted cover 138×138 mm in

stainless steel AISI 304, screwed, class K 3



Illustration shows Art. no. 48 411.51

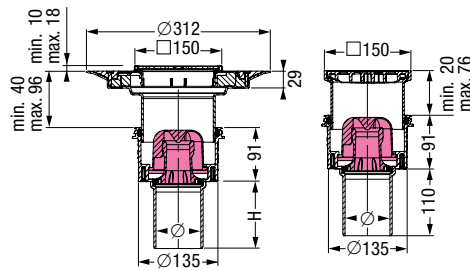


Illustration shows Art. no. 48 458.51, 48 478.51, 48 411.51

Illustration shows Art. no. 48 411.11

Outer diameter Ø (mm) Art. no.

With *Variofix* shallow bed upper section

Ø 58	48 458.51
Ø 78	48 478.51
Ø 83	48 483.51
Ø 110	48 411.51

With connection flange and upper section in ABS

Ø 58	48 458.11
Ø 78	48 478.11
Ø 83	48 483.11
Ø 110	48 411.11

Floor/Roof drain *Ecoguss*

with *Variofix* shallow bed upper section and slotted cover in stainless steel AISI 304

System 125



EN 1253-1

Made in *Ecoguss resistant*, with removable odour trap, sealing water height 50 mm, vertical outlet, with lip seal.

Drainage capacity in l/sec with 20 mm / 10 mm threshold

Ø 110: 2.2 l/sec / 1.0 l/sec.

Installation area 300×300 mm

With *Variofix* shallow bed upper section

in ABS, with pressure sealing flange in stainless steel AISI 304 and with enclosed waterproofing membrane

Cover:

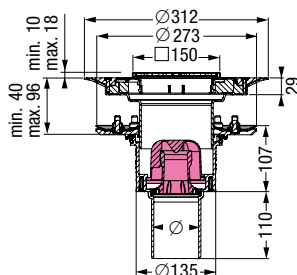
Slotted cover 138×138 mm and rim in

stainless steel AISI 304, screwed,

class K 3



Illustration shows Art. no. 48 811.51



Outer diameter Ø (mm) Art. no.

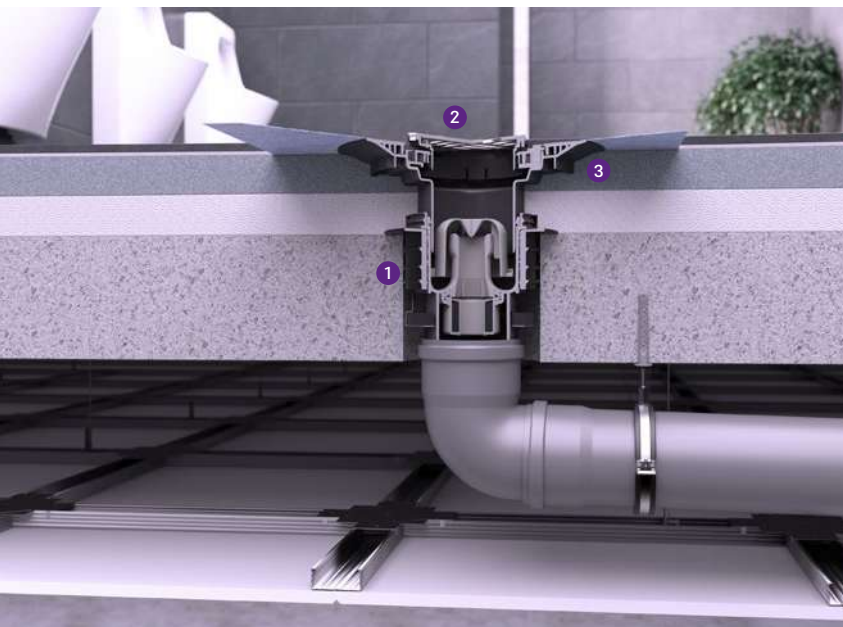
Ø 58	48 858.51
Ø 78	48 878.51
Ø 83	48 883.51
Ø 110	48 811.51

Floor drain *Practicus* made in PP

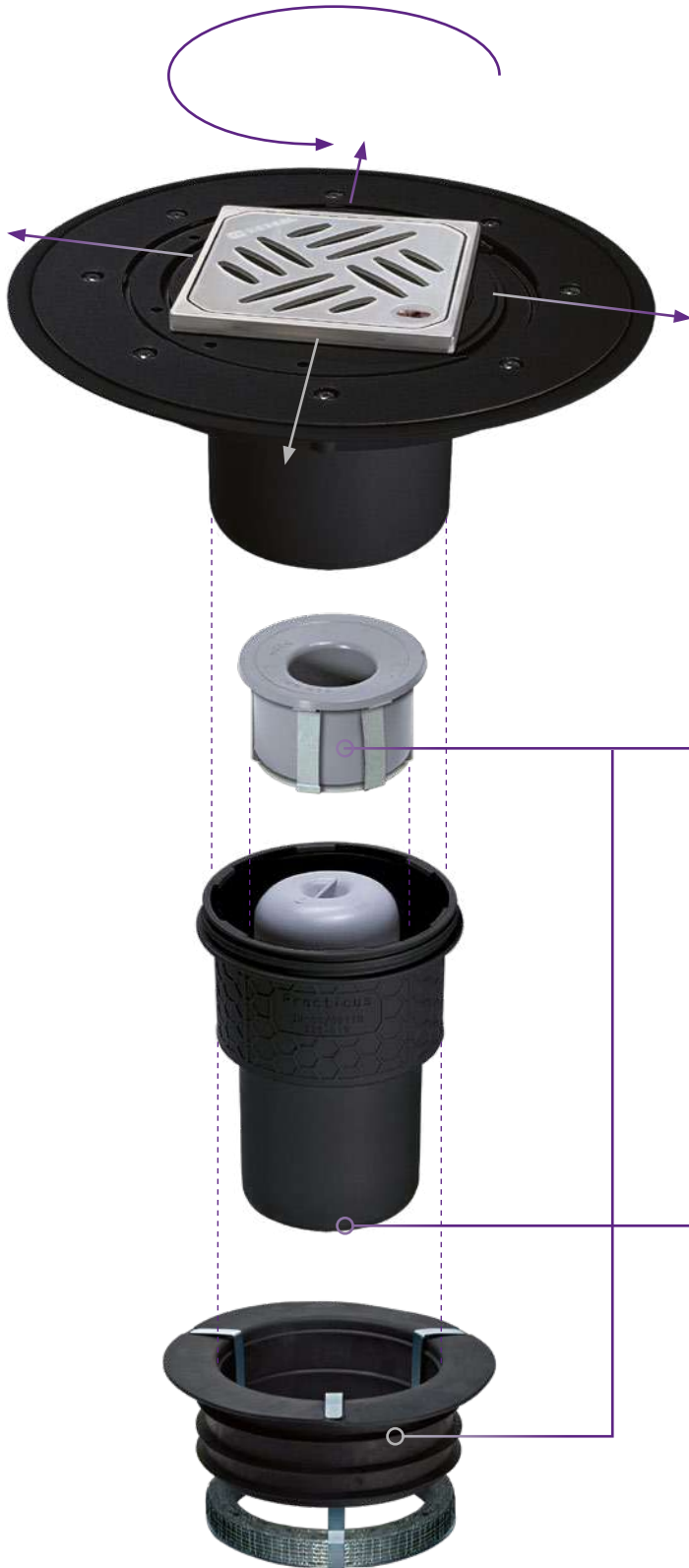
Developed, manufactured and tested for commercial and industrial use.

Our project drain *Practicus* made of the high-quality polymer polypropylene (PP) is an easy to install alternative to drains made of metal. It also offers other advantages: For example, its rustresistant and smooth surface prevents deposits and therefore ensures a strong self-cleaning effect. And thanks to its discharge rate of 1.8 l/s, it is also suitable for showers with particularly high water use. All this makes the *Practicus* a robust solution with diverse possible uses in project drainage.

The *Practicus* is available with lateral or vertical outlet as well as in different outlet sizes from Ø 50 to Ø 110 mm.



- 1 Drain body *Practicus*
- 2 Upper section with cover
- 3 *Variofix* shallow bed upper sections



Variable upper sections

Extremely flexible: our rotatable, tiltable and height-adjustable upper sections. The shallow bed *Variofix* upper section also allows the cover to be moved and thus adapted to the tile pattern.

Highest fire protection standards

Fire-Kit and Quick-Fit

➤ Fire protection: page 247

Outlet diameter

- DN 50: Ø 50 mm
- DN 70: Ø 75 mm
- DN 100: Ø 110 mm

With our modular system 125, we provide numerous possible combinations for our project drains.

➤ Upper sections: page 244

➤ Drain body: page 244

➤ Further accessories: page 246

Practicus with pressure sealing flange

Matrix order system

System 125



EN 1253-1

Drain body

Practicus with pressure sealing flange

in PP, with odour trap.

Drainage capacity in l/sec with 20 mm / 10 mm threshold see table.

Sealing water height 50 mm

➤ Modular system

see pages 244 – 245

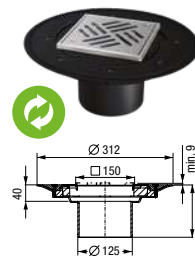
Upper sections

Shallow bed upper section in ABS

with included waterproofing membrane

Slotted cover

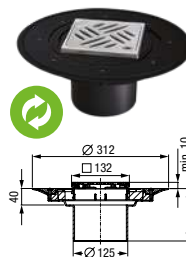
138 × 138 mm and rim in stainless steel AISI 304, class K 3, screwed



Art. no. 48 963

Design cover Kessel

120 × 120 mm and rim in stainless steel AISI 304, class L 15, Lock & Lift locking system



Art. no. 48 904

Upper section in ABS

Design cover Kessel

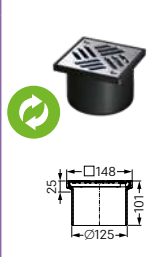
120 × 120 mm and rim in stainless steel AISI 304, class L 15, Lock & Lift locking system



Art. no. 48 201

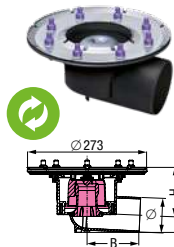
Slotted cover

138 × 138 mm in stainless steel AISI 304, class K 3, screwed



Art. no. 48 950

Drain body with lateral outlet



Ø	H	B
50	120	245
75	107	134
110	90	148

Ø 50 Art. no. 45 159

Ø 75 Art. no. 45 179

Ø 110 Art. no. 45 119

Complete drain comprising a combination of the upper section and drain body

Art. no. 45 159.51

Drainage capacity* 1.6 / 1.2

Art. no. 45 159.53

Drainage capacity* 1.6 / 1.2

Art. no. 45 159.63

Drainage capacity* 1.4 / 1.0

Art. no. 45 159.11

Drainage capacity* 1.4 / 1.0

Art. no. 45 179.51

Drainage capacity* 1.5 / 1.2

Art. no. 45 179.53

Drainage capacity* 1.5 / 1.2

Art. no. 45 179.63

Drainage capacity* 1.3 / 1.1

Art. no. 45 179.11

Drainage capacity* 1.3 / 1.1

Art. no. 45 119.51

Drainage capacity* 1.7 / 1.0

Art. no. 45 119.53

Drainage capacity* 1.7 / 1.0

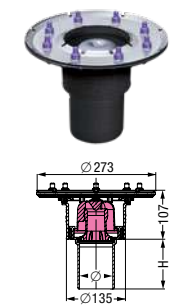
Art. no. 45 119.63

Drainage capacity* 1.5 / 1.0

Art. no. 45 119.11

Drainage capacity* 1.6 / 1.0

Drain body with vertical outlet



Ø	H
50	100
75	110
110	110

Ø 50 Art. no. 45 259

Ø 75 Art. no. 45 279

Ø 110 Art. no. 45 219

Complete drain comprising a combination of the upper section and drain body

Art. no. 45 259.51

Drainage capacity* 2.1 / 1.3

Art. no. 45 259.53

Drainage capacity* 2.1 / 1.3

Art. no. 45 259.63

Drainage capacity* 1.9 / 1.0

Art. no. 45 259.11

Drainage capacity* 1.9 / 1.0

Art. no. 45 279.51

Drainage capacity* 2.0 / 1.0

Art. no. 45 279.53

Drainage capacity* 2.1 / 1.0

Art. no. 45 279.63

Drainage capacity* 1.9 / 1.0

Art. no. 45 279.11

Drainage capacity* 1.9 / 1.0

Art. no. 45 219.51

Drainage capacity* 2.1 / 1.0

Art. no. 45 219.53

Drainage capacity* 2.1 / 1.0

Art. no. 45 219.63

Drainage capacity* 1.9 / 1.0

Art. no. 45 219.11

Drainage capacity* 2.0 / 1.0

* Drainage capacity in l/sec with 20 mm / 10 mm threshold see table

Practicus with connection flange



Matrix order system



Drain body

Practicus with connection flange

in PP, with odour trap.

Drainage capacity in l/sec with 20 mm / 10 mm threshold see table.

Sealing water height 50 mm

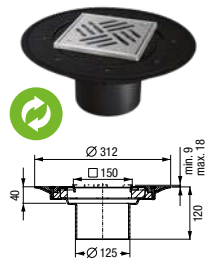
Modular system

see pages 244 – 245

Upper sections

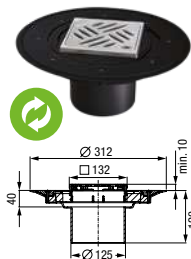
Shallow bed upper section in ABS with included waterproofing membrane

Slotted cover
138×138 mm and rim in stainless steel AISI 304, class K 3, screwed



Art. no. 48 963

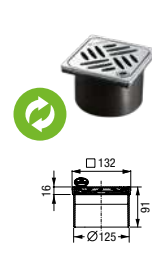
Design cover Kessel
120×120 mm and rim in stainless steel AISI 304, class L 15, Lock & Lift locking system



Art. no. 48 904

Upper section in ABS

Design cover Kessel
120×120 mm and rim in stainless steel AISI 304, class L 15, Lock & Lift locking system



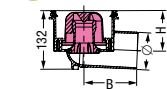
Art. no. 48 201

Slotted cover
138×138 mm in stainless steel AISI 304, class K 3, screwed



Art. no. 48 950

Drain body with lateral outlet



Ø	H	B
50	120	245
75	109	134
110	92	148

Ø 50 Art. no. 45 150

Ø 75 Art. no. 45 170

Ø 110 Art. no. 45 110

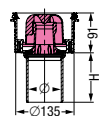
Complete drain comprising a combination of the upper section and drain body

Art. no.	45 150.51	45 150.53	45 150.63	45 150.11
Drainage capacity*	1.6 / 1.3	1.5 / 1.2	1.4 / 1.0	1.4 / 1.0

Art. no.	45 170.51	45 170.53	45 170.63	45 170.11
Drainage capacity*	1.6 / 1.2	1.5 / 1.2	1.4 / 1.1	1.4 / 1.1

Art. no.	45 110.51	45 110.53	45 110.63	45 110.11
Drainage capacity*	1.7 / 1.2	1.6 / 1.0	1.5 / 1.2	1.6 / 1.1

Drain body with vertical outlet



Ø	H
50	100
75	110
110	110

Ø 50 Art. no. 45 250

Ø 75 Art. no. 45 270

Ø 110 Art. no. 45 210

Complete drain comprising a combination of the upper section and drain body

Art. no.	45 250.51	45 250.53	45 250.63	45 250.11
Drainage capacity*	2.2 / 1.3	2.2 / 1.3	2.0 / 1.0	2.0 / 1.0

Art. no.	45 270.51	45 270.53	45 270.63	45 270.11
Drainage capacity*	2.1 / 1.0	2.1 / 1.0	2.0 / 1.0	2.0 / 1.0

Art. no.	45 210.51	45 210.53	45 210.63	45 210.11
Drainage capacity*	2.2 / 1.0	2.2 / 1.0	2.0 / 1.0	2.0 / 1.0

* Drainage capacity in l/sec with 20 mm / 10 mm threshold see table

Floor drain *Practicus*

with slotted cover in ABS

System 125



Made in PP, with removable odour trap, sealing water height 50 mm, with lip seal. Drainage capacity in l/sec with 20 mm / 10 mm threshold lateral outlet: 1.6 l/sec / 1.1 l/sec vertical outlet: 2.0 l/sec / 1.0 l/sec.

Installation area:

lateral outlet: 220 × 180 mm

vertical outlet: 180 × 180 mm

With upper section in ABS

slotted cover 138 × 138 mm in ABS,

black, class K 3



Illustration shows Art. no. 45 110.40 (lateral outlet)

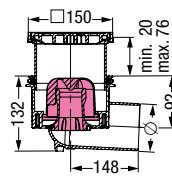


Illustration shows Art. no. 45 110.40 (lateral outlet)

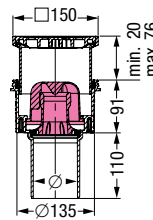


Illustration shows Art. no. 45 210.40 (vertical outlet)

Outer diameter Ø (mm)	Art. no.
Lateral outlet	
Ø 110	45 110.40
Vertical outlet	
Ø 110	45 210.40

Floor drain *Practicus*

with slotted cover in stainless steel AISI 304

System 125



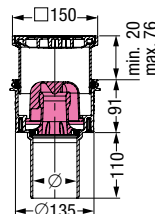
Made in PP, with removable odour trap, sealing water height 50 mm, vertical outlet, with lip seal. Drainage capacity in l/sec with 20 mm / 10 mm threshold Ø 110: 2.0 l/sec / 1.0 l/sec.

Installation area 180 × 180 mm

With upper section in ABS,

slotted cover 138 × 138 mm in stainless

steel AISI 304, screwed, class K 3



Outer diameter Ø (mm)	Art. no.
Ø 50	45 250.11
Ø 75	45 270.11
Ø 110	45 210.11

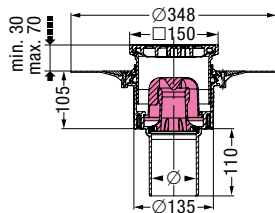
Floor drain *Practicus*

with slotted cover in stainless steel AISI 304



EN 1253-1

Made in PP, with removable odour trap, sealing water height 50 mm, vertical outlet, with lip seal. Drainage capacity in l/sec with 20 mm / 10 mm threshold
 Ø 110: 2.0 l/sec / 1.0 l/sec.
 Installation area 350 × 350 mm
 With upper section in ABS, with glue flange and counter flange, slotted cover 138 × 138 mm in stainless steel AISI 304, screwed, class K 3



Outer diameter Ø (mm)	Art. no.
Ø 110	45 218.11

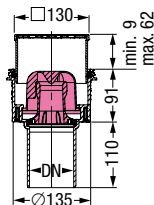
Floor drain *Practicus*

with slotted cover in stainless steel AISI 304



EN 1253-1

Made in PP, with removable odour trap, sealing water height 50 mm, vertical outlet, with lip seal. Drainage capacity in l/sec with 20 mm / 10 mm threshold 2.0 l/sec / 1.0 l/sec.
 Installation area 180 × 180 mm
 With upper section in ABS, slotted cover 120 × 120 mm in stainless steel AISI 304, class K 3



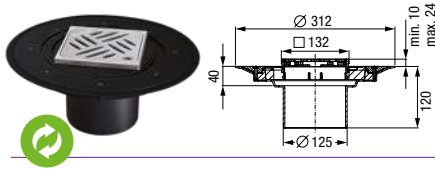
Outer diameter Ø (mm)	Art. no.
Ø 50	45 250.20
Ø 75	45 270.20
Ø 110	45 210.20

Modular system 125

Ecoguss and Practicus

Variofix shallow bed upper sections

with covers in stainless steel



with design cover

in stainless steel AISI 304 or AISI 316L

Material: ABS, rim in stainless steel

Class: L 15 (*Kessel, Oval*) / K 3 (*Spot, Slot*)

Tile thickness: 8 – 21 mm

Cover: 120×120 mm

Anti-slip class design cover *Kessel*:

R9 according to DIN 51130;

C according to DIN 51097

Inclusive: Waterproofing membrane

Cover Art. no.

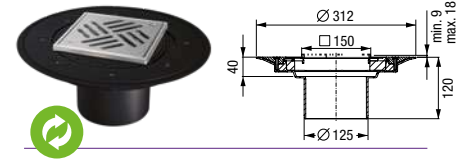
with *Lock & Lift System*

1	AISI 304	48 904
2	AISI 304	48 905
3	AISI 304	48 621
4	AISI 304	48 619
1	AISI 316L	48 204
2	AISI 316L	48 669

Cover Art. no.

without *Lock & Lift System*

1	AISI 304	48 625
2	AISI 304	48 626
3	AISI 304	48 620
4	AISI 304	48 618
2	AISI 316L	48 670



with slotted cover

in stainless steel AISI 304 or AISI 316L

Material: ABS, rim in stainless steel

Class: K 3

Tile thickness: 9 – 18 mm

Cover: 138×138 mm, screwed

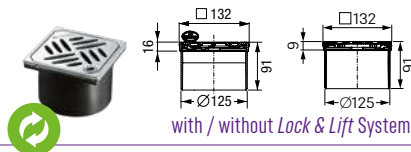
Inclusive: Waterproofing membrane

AISI 304 **Art. no. 48 963**

AISI 316L **Art. no. 48 206**

Upper sections

with covers in stainless steel



mit Designrost

in stainless steel AISI 304 or AISI 316L

Material: ABS, rim in stainless steel

Class: L 15 (*Kessel, Oval*) / K 3 (*Spot, Slot*)

Cover: 120×120 mm

Anti-slip class design cover *Kessel*:

R9 according to DIN 51130;

C according to DIN 51097

Cover Art. no.

with *Lock & Lift System*

1	AISI 304	48 201
2	AISI 304	48 202
3	AISI 304	48 221
4	AISI 304	48 219
1	AISI 316L	48 203
2	AISI 316L	48 227

Cover Art. no.

without *Lock & Lift System*

1	AISI 304	48 225
2	AISI 304	48 226
3	AISI 304	48 220
4	AISI 304	48 218
2	AISI 316L	48 228



with slotted cover

in stainless steel AISI 304

Material: ABS

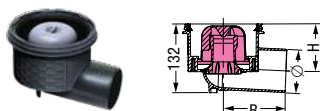
Class: K 3

Cover: 120×120 mm

AISI 304 **Art. no. 48 165**

Drain body *Ecoguss*

with removable odour trap*



with connection flange, lateral outlet

Material: *Ecoguss resistant*

Sealing water height: 50 mm

Ø 58 B×H 245×120 mm **Art. no. 48 358**

Ø 78 B×H 134×109 mm **Art. no. 48 378**

Ø 83 B×H 134×108 mm **Art. no. 48 383**

Ø 110 B×H 148×92 mm **Art. no. 48 311**



with connection flange, vertical outlet

Material: *Ecoguss resistant*

Sealing water height: 50 mm

Ø 58 H 100 mm **Art. no. 48 458**

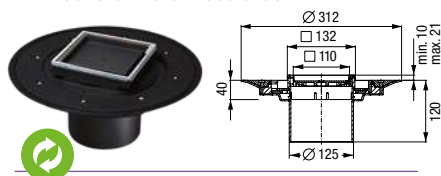
Ø 78 H 110 mm **Art. no. 48 478**

Ø 83 H 110 mm **Art. no. 48 483**

Ø 110 H 110 mm **Art. no. 48 411**

* The *Linearis Comfort* and *Linearis Compact* shower channels already include an odour trap. For this reason, the odour trap must be removed from all drain bodies during installation.

Variofix shallow bed upper sections
with covers in stainless steel



with recessed polymer cover
for on-site tiling

Material: ABS, rim in stainless steel
AISI 304 or AISI 316L

Class: K 3

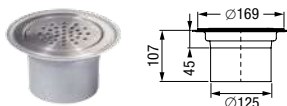
Tile thickness: 10 – 21 mm

Cover: 110×110 mm (polymer)

Inclusive: Waterproofing membrane

AISI 304 **Art. no. 48 906**

Upper sections
for PVC floorings



with cover

in stainless steel AISI 304

Material: Stainless steel AISI 304

Class: L 15

Tile thickness: 1 – 4 mm

Cover: Ø 133 mm, screwed

Note: Not in combination with drain bodies *The Ultraflat* and *Multistop* (Art. no. 48 500)

AISI 304 **Art. no. 59 192**

Upper sections

in stainless steel AISI 304 with glue flange



with slotted cover

in stainless steel AISI 304

Material: Stainless steel AISI 304

Class: K 3

Cover: 100×100 mm

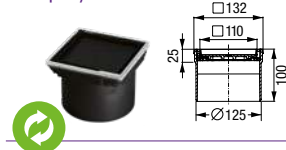
Note: Not in combination with drain bodies *The Ultraflat*, System 125 sludge trap accessory and odour trap.

Custom made (delivery time on request)

AISI 304 **Art. no. 59 165**

Upper sections

with covers in stainless steel and polymer



with tileable cover

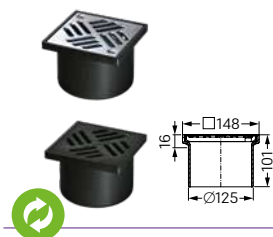
made of polymer

Material: ABS, rim in stainless steel AISI 304 or AISI 316L

Class: K 3

Cover: 110×110 mm

AISI 304 **Art. no. 48 211**
AISI 316L **Art. no. 48 207**



with slotted cover

in stainless steel AISI 304 / 316L or ABS

Material: ABS

Class: K 3

Cover: 138×138 mm, screwed (only in stainless steel)

AISI 304 **Art. no. 48 950**
AISI 316L **Art. no. 48 209**

ABS **Art. no. 48 193**, black



with slotted cover

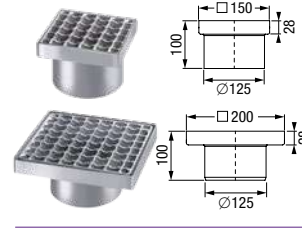
in stainless steel AISI 304

Material: ABS, rim in stainless steel AISI 304

Class: L 15

Cover: 138×138 mm, screwed

AISI 304 **Art. no. 48 951**
AISI 304 **Art. no. 48 176**, anti-slip



with anti-slip drain cover

in stainless steel AISI 304

Material: Stainless steel AISI 304

Class: L 15 / M 125

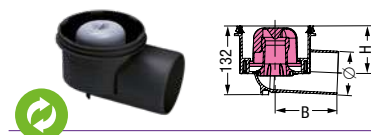
(On-site lining work required)

Cover: 138×138 mm / 200×200 mm

B×H 138×138 mm **Art. no. 54 914**
B×H 200×200 mm **Art. no. 54 916**

Drain body Practicus

with removable odour trap*

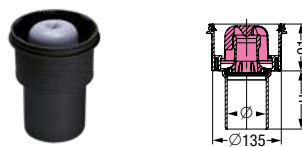


with connection flange, lateral outlet

Material: PP

Sealing water height: 50 mm

Ø 50 B×H 245×120 mm **Art. no. 45 150**
Ø 75 B×H 134×109 mm **Art. no. 45 170**
Ø 110 B×H 148×92 mm **Art. no. 45 110**



with connection flange, vertical outlet

Material: PP

Sealing water height: 50 mm

Ø 50 H 100 mm **Art. no. 45 250**
Ø 75 H 110 mm **Art. no. 45 270**
Ø 110 H 110 mm **Art. no. 45 210**


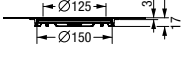

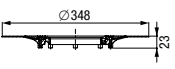

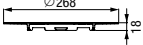

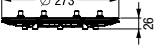


Accessories



Ecoguss and Practicus

System 125

Flanges

			Dimensions in mm	Art. no.
Clip flange	<p>Compatibility: For combination with drain bodies and extension sections; for floor drain <i>Ecoguss</i> and <i>Practicus</i></p> <p>Inclusive: Factory-mounted waterproofing membrane in accordance with EN 1253-1 and DIN 18534-1-W3-1</p>			280×280 44 703
Glue flange with counter flange	<p>Compatibility: For combination with drain bodies and extension sections; also for compound seal; for floor drain <i>Ecoguss</i> and <i>Practicus</i></p> <p>Material: ABS</p>			Ø 348 48 410
without connection flange	<p>Compatibility: For combination with drain bodies and extension sections; for floor drain <i>Ecoguss</i> and <i>Practicus</i></p> <p>Material: ABS</p>			Ø 268 48 409
Pressure sealing flange	<p>Compatibility: For combination with drain bodies and extension sections; for floor drain <i>Ecoguss</i> and <i>Practicus</i></p> <p>Material: Stainless steel AISI 304</p> <p>Inclusive: Seeping water opening</p>			Ø 273 48 407

Waterproofing membranes

			Art. no.
Waterproofing membrane	Compatibility: Art. no. 48 410		48 651
2 component adhesive	Compatibility: For gluing of KESSEL waterproofing membranes		48 650
Elastomer waterproofing membrane	<p>Compatibility: Art. no. 48 407</p> <p>Material: NBR</p>		48 981

Intermediate section

			Art. no.	
with glue flange	<p>Compatibility: Shallow bed gasket</p> <p>Inclusive: With non-mounted waterproofing membrane according to EN 1253-1 and DIN 18534-1-W3-1</p>			48 900

Extension sections

			Art. no.	
without lateral inlet	<p>Compatibility: For floor drain <i>Ecoguss</i> and <i>Practicus</i></p> <p>Material: PP</p> <p>Inclusive: Lip seal</p>			48 987
with lateral inlet Ø 50	<p>Compatibility: For floor drain <i>Ecoguss</i> and <i>Practicus</i></p> <p>Material: PP</p> <p>Inclusive: Lip seal</p>			48 989

Accessories

System 125

Ecoguss and Practicus

Extension sections

with pressure sealing flange

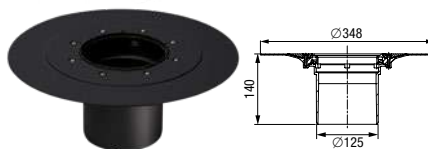
Compatibility: For combination with drain bodies and extension sections; for floor drain *Ecoguss* and *Practicus*
Material: PP



Art. no.
48 404

with glue flange with counter flange

Compatibility: For combination with drain bodies and extension sections; for floor drain *Ecoguss* and *Practicus*
Material: PP

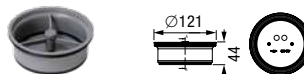


Art. no.
48 403

Hygiene and odour stop

Megastop

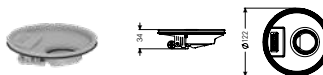
Compatibility: For floor drain *Ecoguss* and *Practicus*
Function: Mechanical odour trap inclusive hair filter for KESSEL upper sections, in combination with design cover with *Lock & Lift* system additional protection against backwater up to 0.1 bar



Art. no.
48 550

Multistop

Compatibility: For floor drain *Ecoguss* and *Practicus*
Function: Odour, foam, rodent and insect stop
Note: Not in combination with shower channel upper sections



Art. no.
48 500

Hair filter

Compatibility: For *Multistop* and floor drain *Ecoguss* and *Practicus*



Art. no.
48 700

Odour trap

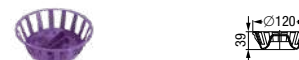
Compatibility: For all upper sections System 125, sealing water height 50 mm according to norm
Note: Not in combination with tileable upper sections



Art. no.
48 600

Sludge trap

Compatibility: For floor drain *Ecoguss* and *Practicus*
Material: Polymer



Art. no.
48 168

Fire protection / Passage seal

Fire-Kit

Compatibility: Only for *Ecoguss* / *Practicus* drains with vertical outlet and odour trap
Function: Fire protection insert
DIBt Certification



Outer diameter Ø (mm)	Art. no.
Ø 58/78/83	48 099
Ø 50/75	48 099
Ø 110	48 100

Quick-Fit with fire protection

Compatibility: Only in combination with *Fire-Kit* protection insert
Function: Passage seal for core drillings with *Ecoguss* and *Practicus* drain bodies, vertical outlet
DIBt Certification



Art. no.
48 990

Quick-Fit without fire protection

Function: Passage seal for core drillings with *Ecoguss* and *Practicus* drain bodies, vertical outlet



Art. no.
48 991

Floor drain / Square channel drains, box and slotted channels

Ferrofix

made in stainless steel AISI 304

The stainless steel solution.

Our *Ferrofix* drains made of stainless steel are particularly durable solutions for drainage in commercial rooms in which hygiene requirements apply. The stainless steel grade AISI 304 (AISI 316L on request) makes the drain suitable for use in areas with the highest standards, for example, in food processing companies or swimming pools.

Our channel drains and square channel drains are available as Express or modular versions and in different lengths. In general the length is up to six metres, other dimensions can be supplied if necessary. On request, we also develop individual solutions, which we also tailor to your requirements.



1 *Ferrofix* floor drain 2 *Ferrofix* box channel

Complete
expanded
product range



Floor drain

Renovation with *Ferrofix*

On request, the *Ferrofix* is also available as an extremely flat model made of AISI 304 stainless steel – ideal for renovation projects. With low installation depths from 100 to 107 mm, the renovation models are particularly compact. The one-piece drains are supplied with optional connection flange or glued flange.

With our modular systems 125 and 200, we provide numerous possible combinations for our project drains.

➤ Upper sections system 100: page 260

➤ Modular system 125: pages 254 – 257

➤ Modular system 200: pages 258 – 259



Square channel drains, box and slotted channels

On request, we supply the *Ferrofix* as a ready-to-install complete linear and square channel with pre-assembled outlet sockets, slip-resistant gratings and channel profiles with adhesive flange for shallow bed waterproofing layers. The channels and square channel drains are combined with the matching drain bodies *Ferrofix* and *Ecoguss* as well as optional accessories.

With our modular systems 100, 125 and 200, we provide numerous possible combinations for our channel drains and square channel drains.

- Upper sections: page 255
- Drain bodies: page 273
- Further accessories: page 275

Floor drains *Ferrofix* with pressure sealing flange

Matrix order system



EN 1253



Drain body

Floor drain *Ferrofix* with pressure sealing flange in stainless steel AISI 304, for connection to SML-pipe, with odour trap. Drainage capacity in l/sec with 20 mm / 10 mm threshold see table. Sealing water height 50 mm

- **Modular system**
see pages 254 – 257
- **Accessories**
see pages 275 – 278

Upper sections

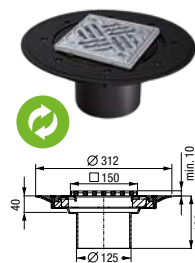
Shallow bed upper section in ABS with included waterproofing membrane

Slotted cover
138 × 138 mm and rim in stainless steel AISI 304, anti-slip, class L 15, screwed

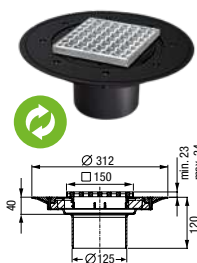
Anti-slip drain cover
138 × 138 mm and rim in stainless steel AISI 304, anti-slip, class L 15.

Upper section in ABS
Slotted cover
138 × 138 mm and rim in stainless steel AISI 304, anti-slip, class L 15, screwed

Upper section in stainless steel AISI 304
Anti-slip drain cover
138 × 138 mm in stainless steel AISI 304, class L 15 / M 125*
*On-site lining work required



Art. no. 48 907



Art. no. 48 965



Art. no. 48 176

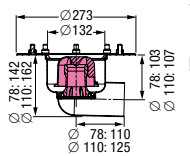


Art. no. 54 914

Drain body with lateral outlet



Ø 78 Art. no. 54 200



Ø 110 Art. no. 54 220

Complete drain comprising a combination of the upper section and drain body

Art. no. 54 200.52

Art. no. 54 200.21

Art. no. 54 200.61

Art. no. 54 200.20

Drainage capacity* 1.8 / 1.2

Drainage capacity* 1.9 / 1.4

Drainage capacity* 1.6 / 0.9

Drainage capacity* 1.7 / 1.6

Art. no. 54 220.52

Art. no. 54 220.21

Art. no. 54 220.61

Art. no. 54 220.20

Drainage capacity* 2.0 / 1.1

Drainage capacity* 2.3 / 1.6

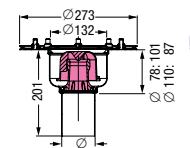
Drainage capacity* 1.9 / 1.0

Drainage capacity* 2.1 / 1.5

Drain body with vertical outlet



Ø 78 Art. no. 54 210



Ø 110 Art. no. 54 230

Complete drain comprising a combination of the upper section and drain body

Art. no. 54 210.52

Art. no. 54 210.21

Art. no. 54 210.61

Art. no. 54 210.20

Drainage capacity* 2.3 / 1.1

Drainage capacity* 2.4 / 1.4

Drainage capacity* 2.3 / 1.1

Drainage capacity* 2.4 / 1.5

Art. no. 54 230.52

Art. no. 54 230.21

Art. no. 54 230.61

Art. no. 54 230.20

Drainage capacity* 2.0 / 1.2

Drainage capacity* 2.3 / 1.6

Drainage capacity* 1.9 / 1.0

Drainage capacity* 2.1 / 1.6



* Drainage capacity in l/sec with 20 mm / 10 mm threshold see table

Floor drains *Ferrofix* with connection flange

Matrix order system



EN 1253



Drain body

Floor drain *Ferrofix* with connection flange in stainless steel AISI 304, for connection to SML-pipe, with odour trap. Drainage capacity in l/sec with 20 mm / 10 mm threshold see table. Sealing water height 50 mm

- **Modular system**
see pages 254 – 257
- **Accessories**
see pages 275 – 278

Upper sections

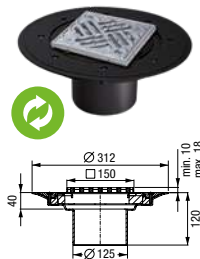
Shallow bed upper section in ABS with included waterproofing membrane

Slotted cover
138 × 138 mm and rim in stainless steel AISI 304, anti-slip, class L 15, screwed

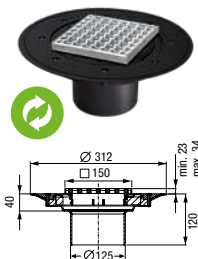
Anti-slip drain cover
138 × 138 mm and rim in stainless steel AISI 304, anti-slip, class L 15.

Upper section in ABS
Slotted cover
138 × 138 mm and rim in stainless steel AISI 304, anti-slip, class L 15, screwed

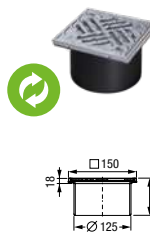
Upper section in stainless steel AISI 304
Anti-slip drain cover
138 × 138 mm in stainless steel AISI 304, class L 15 / M 125*
*On-site lining work required



Art. no. 48 907



Art. no. 48 965



Art. no. 48 176



Art. no. 54 914

Drain body with lateral outlet



Ø 78 Art. no. 54 400

Complete drain comprising a combination of the upper section and drain body

Art. no. 54 400.52

Art. no. 54 400.21

Art. no. 54 400.61

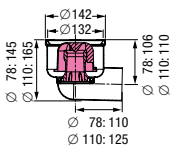
Art. no. 54 400.20

Drainage capacity* 1.7 / 1.1

Drainage capacity* 1.9 / 1.5

Drainage capacity* 1.5 / 1.0

Drainage capacity* 1.7 / 1.6



Ø 110 Art. no. 54 420

Art. no. 54 420.52

Art. no. 54 420.21

Art. no. 54 420.61

Art. no. 54 420.20

Drainage capacity* 1.6 / 1.0

Drainage capacity* 1.8 / 1.5

Drainage capacity* 1.4 / 0.9

Drainage capacity* 1.5 / 1.4

Drain body with vertical outlet



Ø 78 Art. no. 54 410

Art. no. 54 410.52

Art. no. 54 410.21

Art. no. 54 410.61

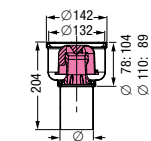
Art. no. 54 410.20

Drainage capacity* 2.4 / 1.2

Drainage capacity* 2.1 / 1.6

Drainage capacity* 2.4 / 1.0

Drainage capacity* 2.4 / 1.6



Ø 110 Art. no. 54 430

Art. no. 54 430.52

Art. no. 54 430.21

Art. no. 54 430.61

Art. no. 54 430.20

Drainage capacity* 2.3 / 1.1

Drainage capacity* 2.0 / 1.5

Drainage capacity* 2.3 / 0.9

Drainage capacity* 2.2 / 1.5



* Drainage capacity in l/sec with 20 mm / 10 mm threshold see table

Floor drains *Ferrofix* with pressure sealing flange

Matrix order system

System 200



Drain body

Floor drain *Ferrofix* with pressure sealing flange in stainless steel AISI 304, for connection to SML-pipe, with odour trap in stainless steel AISI 304. Drainage capacity in l/sec with 20 mm / 10 mm threshold see table. Sealing water height 70 mm

- **Modular system** see pages 258 – 259
- **Accessories** see page 275 – 278

Upper sections

Shallow bed upper section in ABS with included waterproofing membrane

Slotted cover 200 × 200 mm and rim in stainless steel AISI 304, anti-slip, class L 15, screwed



Art. no. 48 978

Anti-slip drain cover 190 × 190 mm and rim in stainless steel AISI 304, anti-slip, class L 15



Art. no. 48 969

Upper section in stainless steel AISI 304

Anti-slip drain cover 190 × 190 mm in stainless steel AISI 304, anti-slip, class M 125



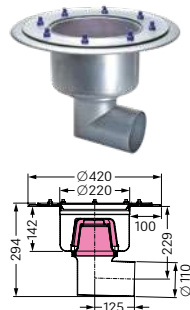
Art. no. 57 410

Slotted cover 190 × 190 mm in stainless steel AISI 304, class M 125



Art. no. 57 420

Drain body with lateral outlet



Ø 110 Art. no. 55 550

Complete drain comprising a combination of the upper section and drain body

Art. no. 55 550.52

Drainage capacity* 2.1 / 0.8

Art. no. 55 550.21

Drainage capacity* 3.2 / 1.4

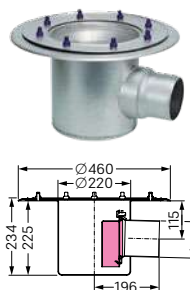
Art. no. 55 550.20

Drainage capacity* 3.2 / 1.4

Art. no. 55 550.30

Drainage capacity* 2.9 / 2.2

Drain body for low installation height



Ø 110 Art. no. 142 025

Complete drain comprising a combination of the upper section and drain body

Art. no. 142 025.52

Drainage capacity* 3.4 / 1.7

Art. no. 142 025.21

Drainage capacity* 3.8 / 2.7

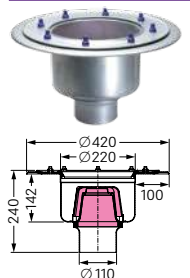
Art. no. 142 025.20

Drainage capacity* 3.8 / 2.7

Art. no. 142 025.30

Drainage capacity* 3.5 / 2.3

Drain body with vertical outlet



Ø 110 Art. no. 55 600

Complete drain comprising a combination of the upper section and drain body

Art. no. 55 600.52

Drainage capacity* 3.0 / 1.9

Art. no. 55 600.21

Drainage capacity* 3.4 / 2.9

Art. no. 55 600.20

Drainage capacity* 3.4 / 2.9

Art. no. 55 600.30

Drainage capacity* 3.0 / 2.2

* Drainage capacity in l/sec with 20 mm / 10 mm threshold see table

Floor drains *Ferrofix* with connection flange

Matrix order system

System 200



Drain body

Floor drain *Ferrofix* with connection flange

in stainless steel AISI 304, for connection to SML-pipe, with odour trap in stainless steel AISI 304. Drainage capacity in l/sec with 20 mm / 10 mm threshold see table. Sealing water height 70 mm

➤ Modular system

see pages 258 – 259

➤ Accessories

see page 275 – 278

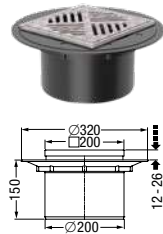
Upper sections

Shallow bed upper section in ABS

with included waterproofing membrane

Slotted cover

200 × 200 mm and rim in stainless steel AISI 304, anti-slip, class L 15, screwed



Art. no. 48 978

Anti-slip drain cover

190 × 190 mm and rim in stainless steel AISI 304, anti-slip, class L 15



Art. no. 48 969

Upper section in stainless steel AISI 304

Anti-slip drain cover

190 × 190 mm in stainless steel AISI 304, anti-slip, class M 125



Art. no. 57 410

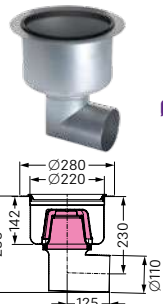
Slotted cover

190 × 190 mm in stainless steel AISI 304, class M 125



Art. no. 57 420

Drain body with lateral outlet



Ø 110 Art. no. 55 350

Complete drain comprising a combination of the upper section and drain body

Art. no. 55 350.52

Drainage capacity* 2.1 / 0.8

Art. no. 55 350.21

Drainage capacity* 3.2 / 1.4

Art. no. 55 350.20

Drainage capacity* 3.2 / 1.4

Art. no. 55 350.30

Drainage capacity* 2.9 / 2.2

Drain body for low installation height:



Ø 110 Art. no. 142 026

Complete drain comprising a combination of the upper section and drain body

Art. no. 142 026.52

Drainage capacity* 3.4 / 1.7

Art. no. 142 026.21

Drainage capacity* 3.8 / 2.7

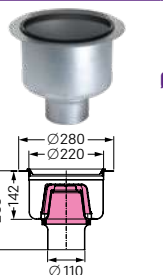
Art. no. 142 026.20

Drainage capacity* 3.8 / 2.7

Art. no. 142 026.30

Drainage capacity* 3.5 / 2.3

Drain body with vertical outlet



Ø 110 Art. no. 55 400

Complete drain comprising a combination of the upper section and drain body

Art. no. 55 400.52

Drainage capacity* 3.0 / 1.9

Art. no. 55 400.21

Drainage capacity* 3.4 / 2.9

Art. no. 55 400.20

Drainage capacity* 3.4 / 2.9

Art. no. 55 400.30

Drainage capacity* 3.0 / 2.2

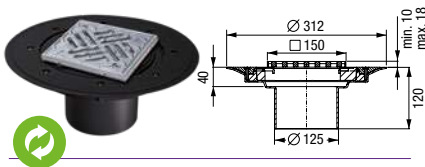
* Drainage capacity in l/sec with 20 mm / 10 mm threshold see table

Modular system 125 *Ferrofix*

Floor drains *Ferrofix* in stainless steel AISI 304

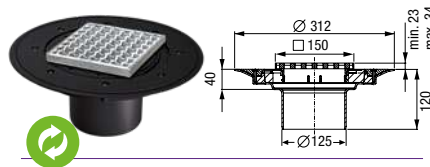
System 125

Variofix shallow bed upper sections



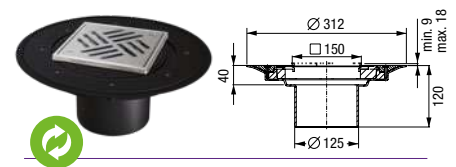
with slotted cover

Material: ABS, rim in stainless steel
Class: L 15
Tile thickness: max. 16 mm
Cover: 150×150 mm, anti-slip, screwed
Anti-slip class:
 R11 according to DIN 51130;
 C according to DIN 51097
Inclusive: Waterproofing membrane
Art. no. 48 907



with anti-slip drain cover

Material: ABS, rim in stainless steel
Class: L 15
Cover: 146×146 mm, anti-slip
Inclusive: Waterproofing membrane
Compatibility:
 Not in combination with drain bodies
The Ultraflat 54 / 79
Art. no. 48 965



with slotted cover

Material: ABS, rim in stainless steel
Class: K 3
Tile thickness: max. 18 mm
Cover: 150×150 mm, screwed
Inclusive: Waterproofing membrane
Art. no. 48 963

Upper sections with glue flange



with anti-slip drain cover

Material: Stainless steel AISI 304
Class: L 15 / M 125
Flange height: 15 mm
Cover: 200×200 mm
Compatibility:
 Not in combination with drain bodies
The Ultraflat 54 / 79
Art. no. 54 917

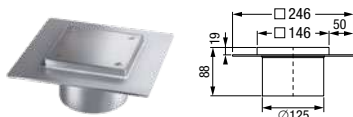


with anti-slip drain cover

Material: Stainless steel AISI 304
Class: L 15 / M 125
Flange height: 6 mm
Cover: 200×200 mm
Compatibility:
 Not in combination with drain bodies
The Ultraflat 54 / 79
Art. no. 54 928

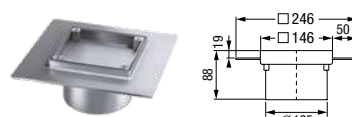


Clean out with glue flange



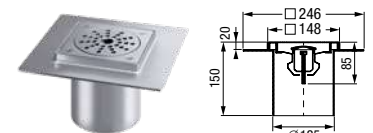
with closed cover

Material: Stainless steel AISI 304
Class: L 15
Flange height: 19 mm
Cover: 146×146 mm, screwed odour-tight, gasket, backwater-proof seal up to 0.5 bar
Compatibility:
 Not in combination with drain bodies
The Ultraflat 54 / 79
Art. no. 54 913



with closed cover plate

Material: Stainless steel AISI 304
Class: L 15
Flange height: 19 mm
Cover: 146×146 mm, screwed, gastight, backwater-proof seal up to 0.5 bar, tileable
Compatibility:
 Not in combination with drain bodies
The Ultraflat 54 / 79
Art. no. 54 911

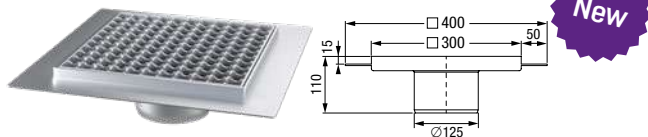


with perforated cover "Easy Open"

Material: Stainless steel AISI 304
Class: K 3
Flange height: 20 mm
Cover: 148×148 mm
Compatibility:
 Not in combination with drain bodies
The Ultraflat 54 / 79
Note: Custom made (delivery time on request)
Art. no. 59 010



Upper sections with glue flange



with anti-slip drain cover

Material: Stainless steel AISI 304

Class: L 15 / M 125

Flange height: 15 mm

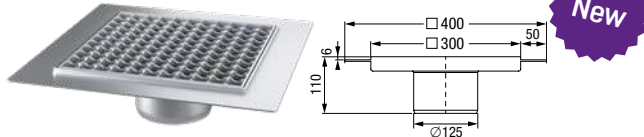
Cover: 300×300 mm

Compatibility:

Not in combination with drain bodies

The Ultraflat 54 / 79

Art. no. 54 923



with anti-slip drain cover

Material: Stainless steel AISI 304

Class: L 15 / M 125

Flange height: 6 mm

Cover: 300×300 mm

Compatibility:

Not in combination with drain bodies

The Ultraflat 54 / 79

Art. no. 54 929

Upper sections with glue flange



with anti-slip drain cover

Material: Stainless steel AISI 304

Class: L 15 / M 125

Flange height: 15 mm

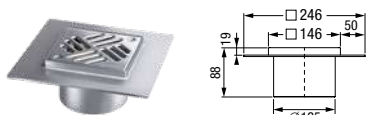
Cover: 146×146 mm

Compatibility:

Not in combination with drain bodies

The Ultraflat 54 / 79

Art. no. 54 915



with slotted cover

Material: Stainless steel AISI 304

Class: K 3

Flange height: 19 mm

Cover: 146×146 mm

Compatibility:

Not in combination with drain bodies

The Ultraflat 54 / 79

Art. no. 54 919



with slotted cover

Material: Stainless steel AISI 304

Class: K 3

Flange height: 20 mm

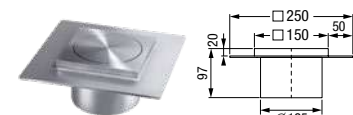
Cover: 100×100 mm

Note: Not usable with System 125 sludge trap accessory and odour trap Art. no. 54 188 and with *The Ultraflat 54 / 79*.

Custom made (delivery time on request)

Art. no. 59 165

Sanitary drain covers with glue flange



with gas and liquid tight cover

Material: Stainless steel AISI 304

Class: L 15

Flange height: 20 mm

Cover: 150×150 mm

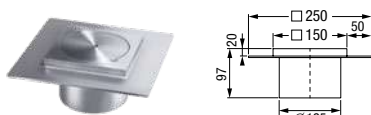
Compatibility:

Not in combination with drain bodies

The Ultraflat 54 / 79

Note: Custom made (delivery time on request)

Art. no. 59 012



with gas and liquid tight cover

Material: Stainless steel AISI 304

Class: L 15

Flange height: 20 mm

Cover: 150×150 mm, screwed, backwater-proof seal up to 0.5 bar

Compatibility:

Not in combination with drain bodies

The Ultraflat 54 / 79

Note: Custom made (delivery time on request)

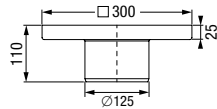
Art. no. 59 014



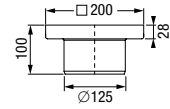
Modular system 125 *Ferrofix*

Floor drains *Ferrofix* in stainless steel AISI 304

Upper sections



New



with anti-slip drain cover

Material: Stainless steel AISI 304

Class: L 15 / M 125

(On-site lining work required)

Cover: 300×300 mm

Compatibility:

Not in combination with drain bodies

The Ultraflat 54 / 79

Art. no. 54 926

with anti-slip drain cover

Material: Stainless steel AISI 304

Class: L 15 / M 125

(On-site lining work required)

Cover: 200×200 mm

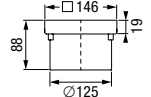
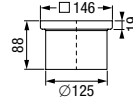
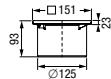
Compatibility:

Not in combination with drain bodies

The Ultraflat 54 / 79

Art. no. 54 916

Clean outs



with rim and closed cover

Material: ABS, cover in stainless steel

Class: L 15

Cover: 150×150 mm, screwed, with gasket

Compatibility:

Not in combination with drain bodies

The Ultraflat 54 / 79

Art. no. 54 920

with closed cover

Material: Stainless steel AISI 304

Class: L 15

Cover: 150×150 mm, screwed odour-tight, gasket, backwater-proof seal up to 0.5 bar

Compatibility:

Not in combination with drain bodies

The Ultraflat 54 / 79

Art. no. 54 912

with closed cover plate

Material: Stainless steel AISI 304

Class: L 15

Cover: 150×150 mm, screwed, gastight, backwater-proof seal up to 0.5 bar, tileable

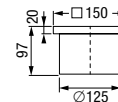
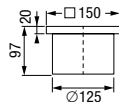
Compatibility:

Not in combination with drain bodies

The Ultraflat 54 / 79

Art. no. 54 910

Sanitary upper sections



with gas and liquid tight cover

Material: Stainless steel AISI 304

Class: L 15

Cover: 150×150 mm

Compatibility:

Not in combination with drain bodies

The Ultraflat 54 / 79

Note: Custom made (delivery time on request),

cover available with removal threads

Art. no. 59 011

with gas and liquid tight cover

Material: Stainless steel AISI 304

Class: L 15

Cover: 150×150 mm, screwed, backwater-proof seal up to 0.5 bar

Compatibility:

Not in combination with drain bodies

The Ultraflat 54 / 79

Note: Custom made (delivery time on request),

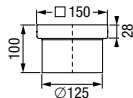
cover available with removal threads

Art. no. 59 013

System 125



Upper sections



with anti-slip drain cover

Material: Stainless steel AISI 304

Class: L 15 / M 125

(On-site lining work required)

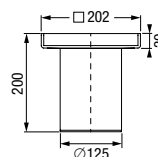
Cover: 138×138 mm

Compatibility:

Not in combination with drain bodies

The Ultraflat 54 / 79

Art. no. 54 914



with slotted cover

Material: Stainless steel AISI 304

Class: D (On-site lining work required)

Cover: 190×190 mm, screwed

Compatibility:

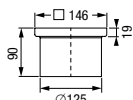
Not in combination with drain bodies

The Ultraflat 54 / 79

Note: Custom made (delivery time on request)

Art. no. 59 400

Upper sections



with slotted cover

Material: Stainless steel AISI 304

Class: K 3

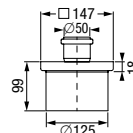
Cover: 138×138 mm

Compatibility:

Not in combination with drain bodies

The Ultraflat 54 / 79

Art. no. 48 977



with cover plate / round inlet slot

Material: Stainless steel AISI 304

Class: K 3

Cover: 150×150 mm, with insertion socket connection Ø 50 as free inlet to the floor drain

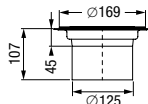
Compatibility:

Not in combination with drain bodies

The Ultraflat 54 / 79

Art. no. 48 435

Upper sections for PVC floorings



with cover

Material: Stainless steel AISI 304

Class: L 15

Tile thickness: 1 – 4 mm

Cover: Ø 133 mm, screwed

Compatibility:

Not in combination with drain bodies

The Ultraflat 54 / 79

Note: Custom made (delivery time on request)

Art. no. 59 192

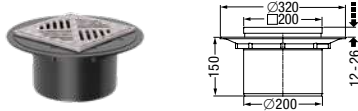


Modular system 200 *Ferrofix*

Floor drains *Ferrofix* in stainless steel AISI 304

System 200

Variofix shallow bed upper sections



with slotted cover

Material: ABS, rim in stainless steel
Class: L 15
Tile thickness: max. 23 mm
Cover: 200×200 mm, anti-slip, screwed
Inclusive: Waterproofing membrane
Art. no. 48 978



with anti-slip drain cover

Material: ABS, rim in stainless steel
Class: L 15
Cover: 200×200 mm, anti-slip
Inclusive: Waterproofing membrane
Art. no. 48 969

Upper section with glue flange



with slotted cover

Class: L 15 / M 125
Cover: 200×200 mm
Note: Custom made (delivery time on request)
Art. no. 57 420-KF



with slotted cover

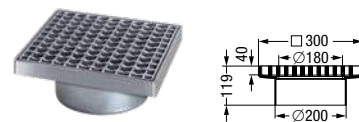
Class: L 15 / M 125
Cover: 300×300 mm
Note: Custom made (delivery time on request)
Art. no. 57 425-KF

Upper sections



with anti-slip drain cover

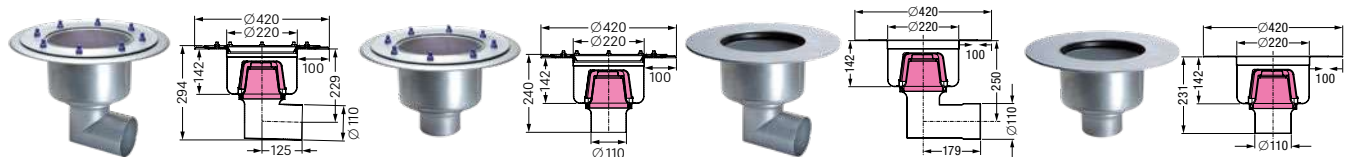
Class: M 125
Cover: 200×200 mm, anti-slip
Art. no. 57 410



with anti-slip drain cover

Class: M 125 (On-site lining work required)
Cover: 290×290 mm, anti-slip
Art. no. 57 415

Drain bodies



with pressure sealing flange

Version: Odour trap, connection to SML-pipe
Outlet: Lateral / vertical Ø 110
Sealing water height: 70 mm
 Lateral outlet **Art. no. 55 550**
 Vertical outlet **Art. no. 55 600**

with glue flange

Version: Odour trap, connection to SML-pipe
Outlet: Lateral / vertical Ø 110
Sealing water height: 70 mm
 Lateral outlet **Art. no. 55 550-KF**
 Vertical outlet **Art. no. 55 600-KF**

System 200



Upper sections with glue flange



with anti-slip drain cover

Class: L 15 / M 125

Cover: 200×200 mm

Note: Custom made (delivery time on request)

Art. no. 57 410-KF

with anti-slip drain cover

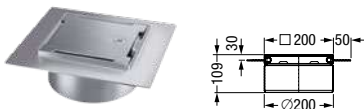
Class: L 15 / M 125

Cover: 300×300 mm

Note: Custom made (delivery time on request)

Art. no. 57 415-KF

Upper sections with glue flange



with closed cover

Class: L 15 / M 125

Cover: 200×200 mm

Compatibility: Special key Art. no. 48 954-SL (optional)

Version: Lateral drain slots, safety valve system

Note: Custom made (delivery time on request)

Art. no. 48 954-S-V2A-KF

Upper sections



with slotted cover

Class: M 125

Cover: 200×200 mm

Art. no. 57 420

with slotted cover

Class: M 125 (On-site lining work required)

Cover: 290×290 mm

Art. no. 57 425

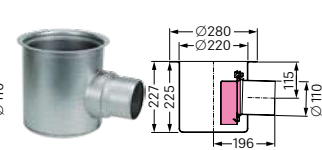
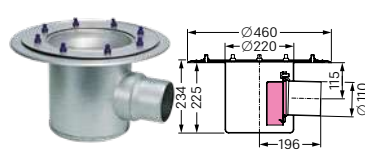
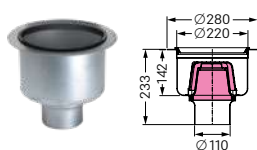
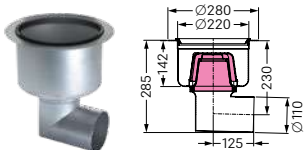
with round-slot cover plate

Class: M 125 (On-site lining work required)

Cover: 290×290 mm, anti-slip

Art. no. 57 435

Drain bodies



with connection flange

Version: Odour trap, connection to SML-pipe

Outlet: Lateral / vertical Ø 110

Sealing water height: 70 mm

Lateral outlet Art. no. 55 350
Vertical outlet Art. no. 55 400

with pressure sealing flange / connection flange

Version: Odour trap, connection to SML-pipe

Outlet: Lateral / vertical Ø 110

Sealing water height: 70 mm

Pressure sealing flange Art. no. 142 025
Connection flange Art. no. 142 026



Renovation drain *Ferfofix*

made of stainless steel AISI 304, superflat

Made of stainless steel AISI 304
Lateral outlet, with removable odour trap,
sealing water height 50 mm,
Drainage capacity 0.8 l/sec flow rate.
Design height only 107 mm
With slotted cover 138 × 138 mm
in stainless steel AISI 304, class L 15

Note: Custom made (delivery time on request)

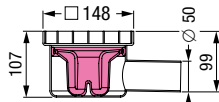


Illustration shows Art. no. 59 305

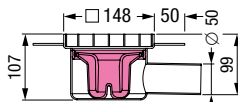


Illustration shows Art. no. 59 315



Illustration shows Art. no. 59 305



Illustration shows Art. no. 59 315

System 125



Outer diameter Ø (mm)	Art. no.
With connection flange	
Ø 50	59 305
With glue flange	
Ø 50	59 315

Renovation drain *Ferfofix*

made of stainless steel AISI 304, superflat

Made of stainless steel AISI 304
Lateral outlet, with removable odour trap,
sealing water height 50 mm,
Drainage capacity 0.8 l/sec flow rate.
Design height only 100 mm
With slotted cover 138 × 138 mm
in stainless steel AISI 304, screwed,
class K 3

Note: Custom made (delivery time on request)

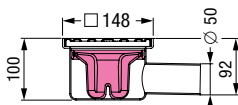


Illustration shows Art. no. 59 325

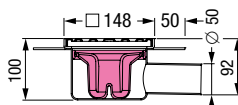


Illustration shows Art. no. 59 335



Illustration shows Art. no. 59 325



Illustration shows Art. no. 59 335

System 125

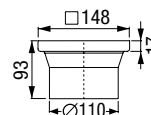


Outer diameter Ø (mm)	Art. no.
With connection flange	
Ø 50	59 325
With glue flange	
Ø 50	59 335

Clean-out *Ferfofix* Ø 110

for direct access to piping

Upper section in ABS. With closed cover and
rim 150 × 150 mm made of stainless steel AISI
304, class K 3, screwed, without gasket



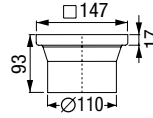
System 100

Connection Ø	Art. no.
Ø 110	27 1916

Clean-out *Ferrofix* Ø 110

for direct access to piping

Upper section in ABS. With closed cover and rim 150×150 mm made of stainless steel AISI 304, class L 15, screwed, without gasket



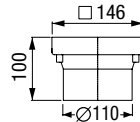
System 100

Connection Ø	Art. no.
Ø 110	27 1966

Clean-out *Ferrofix* Ø 110

for direct access to piping

Upper section made of stainless steel AISI 304. With closed, screw-type cover plate 146×146 mm made of stainless steel AISI 304, class L 15, gastight and a backwater-proof seal up to 0.5 bar, tileable



System 100

Connection Ø	Art. no.
Ø 110	27 177-PLF

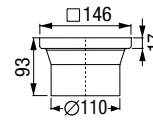
Note: Custom made (delivery time on request)



Clean-out *Ferrofix* Ø 110

for direct access to piping

Upper section made of stainless steel AISI 304. With closed, screw-type cover plate 146×146 mm made of stainless steel AISI 304, class L 15, screwed odour-tight, with gasket, with a backwater-proof seal up to 0.5 bar



System 100

Connection Ø	Art. no.
Ø 110	27 177-PL

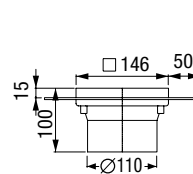
Note: Custom made (delivery time on request)



Clean-out *Ferrofix*

with glue flange, for direct access to piping

Upper section made of stainless steel AISI 304, with closed, screw-type cover plate 146×146 mm made of stainless steel AISI 304, class L 15, screwed odour-tight, with gasket, gastight and a backwater-proof seal up to 0.5 bar, tileable



System 100

Connection Ø	Art. no.
Ø 110	27 177-PLF-KF

Note: Custom made (delivery time on request)



Clean-out *Ferrofix*

with glue flange, for direct access to piping

Upper section made of stainless steel AISI 304. With closed cover 146×146 mm made of stainless steel AISI 304, class L 15, screwed odour-tight, with gasket, with a backwater-proof seal up to 0.5 bar



Connection Ø	Art. no.
Ø 110	27 177-PL-KF

Note: Custom made (delivery time on request)

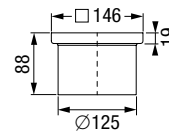


Clean-out *Ferrofix* Ø 125

for direct access to piping

Upper section made of stainless steel AISI 304. With closed, screw-type cover plate 150×150 mm made of stainless steel AISI 304, class L 15, screwed odour-tight, with gasket, with a backwater-proof seal up to 0.5 bar

Compatibility: Not in combination with drain bodies *The Ultraflat 54* and *79*



System 125

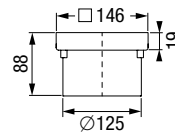
Connection Ø	Art. no.
Ø 125	54 912

Clean-out *Ferrofix* Ø 125

for direct access to piping

Upper section made of stainless steel AISI 304. With closed, screw-type cover plate 150×150 mm made of stainless steel AISI 304, class L 15, gastight and a backwater-proof seal up to 0.5 bar, tileable

Compatibility: Not in combination with drain bodies *The Ultraflat 54* and *79*



System 125

Connection Ø	Art. no.
Ø 125	54 910

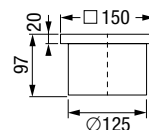
Sanitary upper section *Ferrofix* Ø 125

for direct access to piping

Upper section made of stainless steel AISI 304. With gas and liquid tight cover 150×150 mm made of stainless steel AISI 304, class L 15

Compatibility: Not in combination with drain bodies *The Ultraflat 54* and *79*

Note: Custom made (delivery time on request), cover available with removal threads



System 125

Connection Ø	Art. no.
Ø 125	59 011

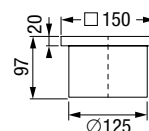
Sanitary upper section *Ferrofix* Ø 125

for direct access to piping

Upper section made of stainless steel AISI 304. With gas and liquid tight cover 150×150 mm made of stainless steel AISI 304, class L 15, screwed, backwater-proof seal up to 0.5 bar

Compatibility: Not in combination with drain bodies *The Ultraflat 54* and *79*

Note: Custom made (delivery time on request), cover available with removal threads



System 125

Connection Ø	Art. no.
Ø 125	59 013

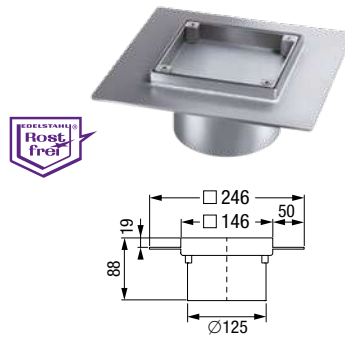
Clean-out *Ferrofix* Ø 125

System 125

with glue flange, for direct access to piping

Upper section made of stainless steel AISI 304. With closed cover plate 146×146 mm made of stainless steel AISI 304, class L 15, screwed, gastight and a backwater-proof seal up to 0.5 bar

Compatibility: Not in combination with drain bodies *The Ultraflat 54* and *79*



Connection Ø	Art. no.
Ø 125	54 911

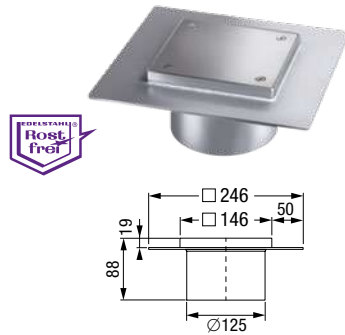
Clean-out *Ferrofix* Ø 125

System 125

with glue flange, for direct access to piping

Upper section made of stainless steel AISI 304. With closed cover plate 146×146 mm made of stainless steel AISI 304, class L 15, screwed odour-tight, with gasket, with a backwater-proof seal up to 0.5 bar

Compatibility: Not in combination with drain bodies *The Ultraflat 54* and *79*



Connection Ø	Art. no.
Ø 125	54 913

Sanitary upper section *Ferrofix* Ø 125

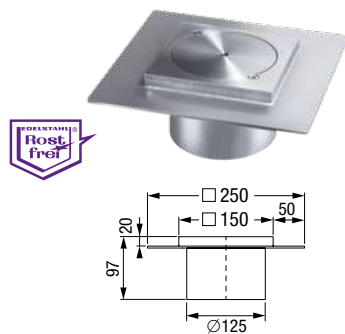
System 125

with glue flange, for direct access to piping

Upper section made of stainless steel AISI 304. With gas and liquid tight cover 150×150 mm made of stainless steel AISI 304, class L 15, screwed, backwater-proof seal up to 0.5 bar

Compatibility: Not in combination with drain bodies *The Ultraflat 54* and *79*

Note: Custom made (delivery time on request)



Connection Ø	Art. no.
Ø 125	59 014

Sanitary upper section *Ferrofix* Ø 125

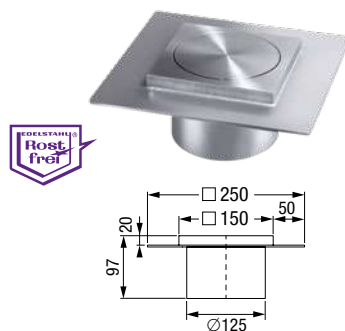
System 125

with glue flange, for direct access to piping

Upper section made of stainless steel AISI 304. With gas and liquid tight cover 150×150 mm made of stainless steel AISI 304, class L 15

Compatibility: Not in combination with drain bodies *The Ultraflat 54* and *79*

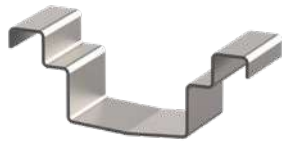
Note: Custom made (delivery time on request)



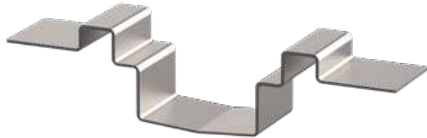
Connection Ø	Art. no.
Ø 125	59 012

Flange variants for floor trays, box and slotted channels

When planning the drainage components in large kitchens, special attention must be paid to the interface between the waterproofing layer and the floor channel. At KESSEL you can obtain solutions that meet the requirements of interfaces and standards with different flange variants, which are tailored to your individual floor covering.

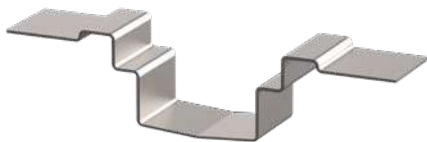


With no flange



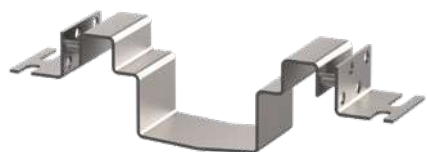
Glued flange, flange height 15 mm

For connecting to waterproofing systems with panels and tiles. (With a 50 mm flange to DIN 18534).



Glued flange, flange height 6 mm

For connecting to floor coating systems (e.g. epoxy resin).



Tile connection angle profile

For use with thermally exposed channels.

Box channel *Ferrofix* with glue flange

System 125

for installation in a concrete slab, flange height 15 mm

Material: Stainless steel AISI 304, material thickness 2.0 mm, acid-treated in pickling bath, ground visible edges

Version:

- Longitudinal and transverse slopes
- Feet for height adjustment
- Drain pipes in stainless steel
- Channel profile for shallow bed waterproofing, with adhesive jointing edge 15 mm deep and folded 50 mm outwards, all round, with welded mitring

Cover:

- Slotted cover in stainless steel AISI 304
- Anti-slip R12
- Acid-treated in pickling bath
- Mesh width 23 × 23 mm
- Load class L 15 (1.5 ton.)

➤ **Optional as accessory:**

Matching drain body System 125 see page 273

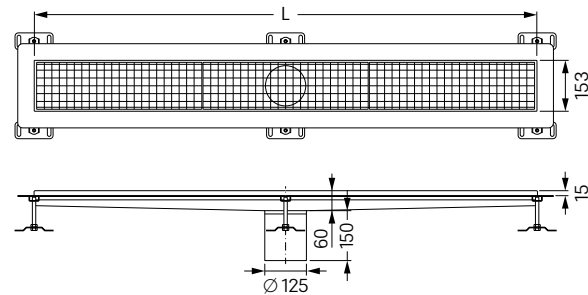


Illustration shows B = 153 mm

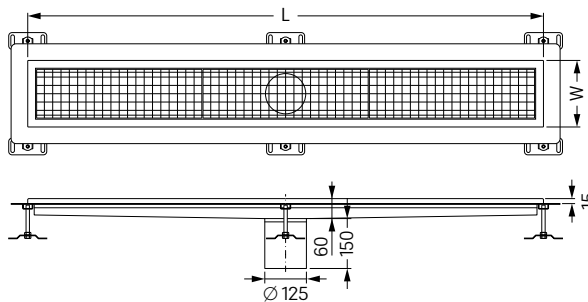


Illustration shows B = 200 / 300 / 400 mm

Dimensions W×L×H in mm

Art. no.

153×511×60	60 15 050*
153×1011×60	60 15 100*
153×1511×60	60 15 150*
153×2011×60	60 15 200*
153×2511×60	60 15 250
153×3011×60	60 15 300
<hr/>	
200×550×60	60 20 050
200×1050×60	60 20 100
200×1550×60	60 20 150
200×2050×60	60 20 200
200×2550×60	60 20 250
200×3050×60	60 20 300
<hr/>	
300×550×60	60 30 050*
300×1050×60	60 30 100*
300×1550×60	60 30 150*
300×2050×60	60 30 200*
300×2550×60	60 30 250
300×3050×60	60 30 300
<hr/>	
400×550×60	60 40 050
400×1050×60	60 40 100
400×1550×60	60 40 150
400×2050×60	60 40 200
400×2550×60	60 40 250
400×3050×60	60 40 300

* available ex stock

Box channel *Ferrofix* with glue flange

System 125

for installation in a concrete slab, flange height 6 mm

Material: Stainless steel AISI 304, material thickness 1.5 mm, acid-treated in pickling bath, ground visible edges

Version:

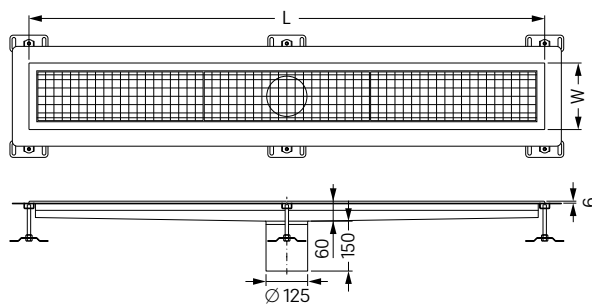
- Longitudinal and transverse slopes
- Feet for height adjustment
- Drain pipes in stainless steel
- Channel profile for connecting to floor coatings (e.g. epoxy resin), with adhesive edge 6 mm deep and 50 mm folded outwards, all round, with welded mitres

Cover:

- Slotted cover in stainless steel AISI 304
- Anti-slip R12
- Acid-treated in pickling bath
- Mesh width 23×23 mm
- Load class L 15 (1.5 ton.)

➤ **Optional as accessory:**

Matching drain body System 125 see page 273



Dimensions W×L×H in mm

Art. no.

200×550×60	62 20 050
200×1050×60	62 20 100
200×1550×60	62 20 150
200×2050×60	62 20 200
200×2550×60	62 20 250
200×3050×60	62 20 300
300×550×60	62 30 050
300×1050×60	62 30 100
300×1550×60	62 30 150
300×2050×60	62 30 200
300×2550×60	62 30 250
300×3050×60	62 30 300
400×550×60	62 40 050
400×1050×60	62 40 100
400×1550×60	62 40 150
400×2050×60	62 40 200
400×2550×60	62 40 250
400×3050×60	62 40 300

Box channel *Ferrofix* with tile connection angle

System 125

for installation in a concrete slab

Material: Stainless steel AISI 304, material thickness 2.0 mm, acid-treated in pickling bath, ground visible edges

Version:

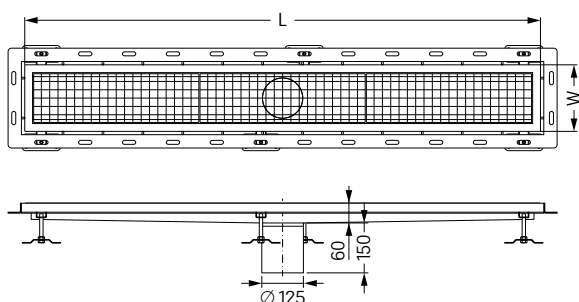
- Longitudinal and transverse slopes
- Feet for height adjustment
- Drain pipes in stainless steel
- Channel profile for connecting to floorings with particularly high thermal exposure, with welded mitres

Cover:

- Slotted cover in stainless steel AISI 304
- Anti-slip R12
- Acid-treated in pickling bath
- Mesh width 23 × 23 mm
- Load class L 15 (1.5 ton.)

➤ Optional as accessory:

Matching drain body System 125 see page 273



Dimensions W×L×H in mm

Art. no.

200×550×60	63 20 050
200×1050×60	63 20 100
200×1550×60	63 20 150
200×2050×60	63 20 200
200×2550×60	63 20 250
200×3050×60	63 20 300
300×550×60	63 30 050
300×1050×60	63 30 100
300×1550×60	63 30 150
300×2050×60	63 30 200
300×2550×60	63 30 250
300×3050×60	63 30 300
400×550×60	63 40 050
400×1050×60	63 40 100
400×1550×60	63 40 150
400×2050×60	63 40 200
400×2550×60	63 40 250
400×3050×60	63 40 300

Box channel *Ferrofix* without glue flange

System 125

for installation in a concrete slab

Material: Stainless steel AISI 304, material thickness 2.0 mm, acid-treated in pickling bath, ground visible edges

Version:

- Longitudinal and transverse slopes
- Feet for height adjustment
- Drain pipes in stainless steel

Cover:

- Slotted cover in stainless steel AISI 304
- Anti-slip R12
- Acid-treated in pickling bath
- Mesh width 23×23 mm
- Load class L 15 (1.5 ton.)

➤ **Optional as accessory:**

Matching drain body System 125 see page 273

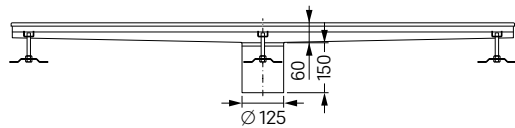
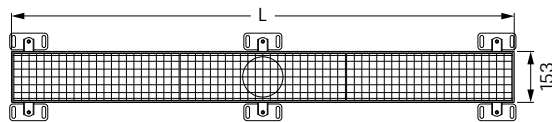


Illustration shows B = 153 mm

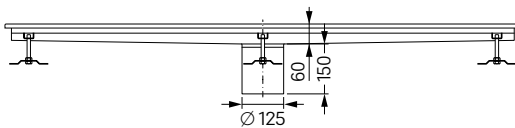
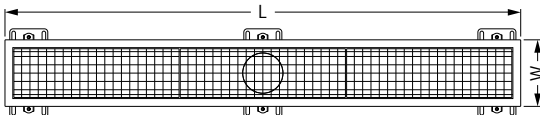


Illustration shows B = 200 / 300 / 400 mm

Dimensions W×L×H in mm	Art. no.
153×511×60	61 15 050
153×1011×60	61 15 100
153×1511×60	61 15 150
153×2011×60	61 15 200
153×2511×60	61 15 250
153×3011×60	61 15 300
<hr/>	
200×550×60	61 20 050
200×1050×60	61 20 100
200×1550×60	61 20 150
200×2050×60	61 20 200
200×2550×60	61 20 250
200×3050×60	61 20 300
<hr/>	
300×550×60	61 30 050
300×1050×60	61 30 100
300×1550×60	61 30 150
300×2050×60	61 30 200
300×2550×60	61 30 250
300×3050×60	61 30 300
<hr/>	
400×550×60	61 40 050
400×1050×60	61 40 100
400×1550×60	61 40 150
400×2050×60	61 40 200
400×2550×60	61 40 250
400×3050×60	61 40 300

Slotted channel *Ferrofix* with glue flange

System 125

for installation in a concrete slab, flange height 15 mm

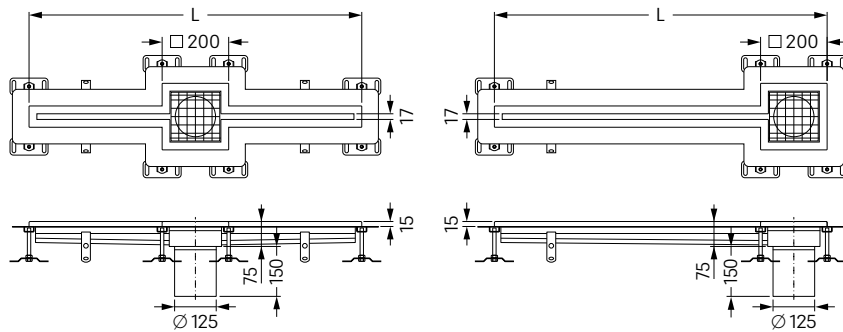
Material: Stainless steel AISI 304, material thickness 2.0 mm, acid-treated in pickling bath, ground visible edges

Version:

- Longitudinal and transverse slopes
- Feet for height adjustment
- Drain pipes in stainless steel
- Channel profile for shallow bed waterproofing, with adhesive jointing edge 15 mm deep and folded 50 mm outwards, all round, with welded mitring
- Load class L 15 (1.5 ton.)

➤ **Optional as accessory:**

Matching drain body System 125 see page 273



Dimensions W×L×H in mm

Art. no.

with inlet in the middle

17×1000×75, M	60 02 100
17×1400×75, M	60 02 140
17×2000×75, M	60 02 200
17×3000×75, M	60 02 300
17×4000×75, M	60 02 400

with inlet at the end of the channel

17×1000×75, A	60 02 101
17×1400×75, A	60 02 141
17×2000×75, A	60 02 201
17×3000×75, A	60 02 301
17×4000×75, A	60 02 401

Slotted channel *Ferrofix* with glue flange

System 125

for installation in a concrete slab, flange height 6 mm

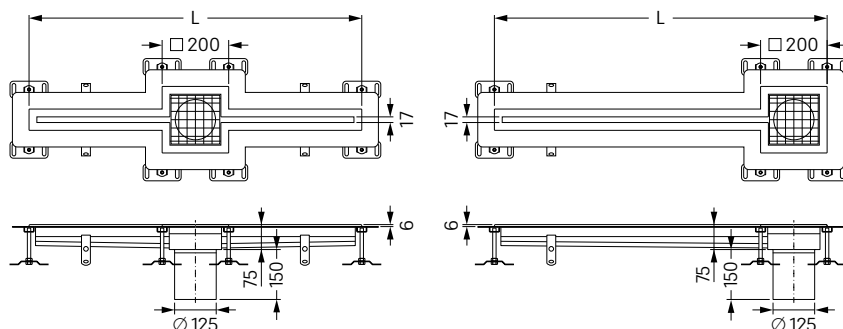
Material: Stainless steel AISI 304, material thickness 1.5 mm, acid-treated in pickling bath, ground visible edges

Version:

- Longitudinal and transverse slopes
- Feet for height adjustment
- Drain pipes in stainless steel
- Channel profile for shallow bed waterproofing, with adhesive jointing edge 15 mm deep and folded 50 mm outwards, all round, with welded mitring
- Load class L 15 (1.5 ton.)

➤ **Optional as accessory:**

Matching drain body System 125 see page 273



Dimensions W×L×H in mm

Art. no.

with inlet in the middle

17×1000×75, M	62 02 100
17×1400×75, M	62 02 140
17×2000×75, M	62 02 200
17×3000×75, M	62 02 300
17×4000×75, M	62 02 400

with inlet at the end of the channel

17×1000×75, A	62 02 101
17×1400×75, A	62 02 141
17×2000×75, A	62 02 201
17×3000×75, A	62 02 301
17×4000×75, A	62 02 401

Slotted channel *Ferrofif* Tile connection angle profile

System 125

for installation in a concrete slab

Material: Stainless steel AISI 304, material thickness 2.0 mm, acid-treated in pickling bath, ground visible edges

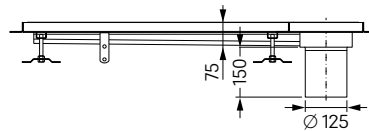
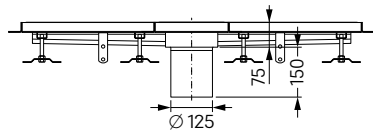
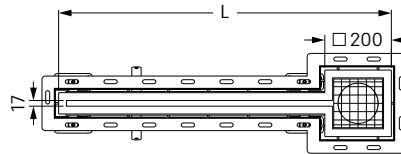
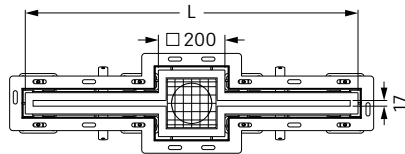
Version:

- Longitudinal and transverse slopes
- Feet for height adjustment
- Drain pipes in stainless steel
- Channel profile for connecting to floorings with particularly high thermal exposure, with welded mitres
- Load class L 15 (1.5 ton.)



➤ **Optional as accessory:**

Matching drain body System 125 see page 273



Dimensions W×L×H in mm

Art. no.

with inlet in the middle

17×1000×75, M	63 02 100
17×1400×75, M	63 02 140
17×2000×75, M	63 02 200
17×3000×75, M	63 02 300
17×4000×75, M	63 02 400

with inlet at the end of the channel

17×1000×75, A	63 02 101
17×1400×75, A	63 02 141
17×2000×75, A	63 02 201
17×3000×75, A	63 02 301
17×4000×75, A	63 02 401

Slotted channel *Ferrofif* without glue flange

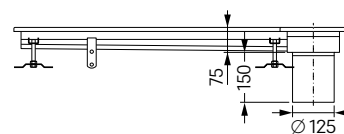
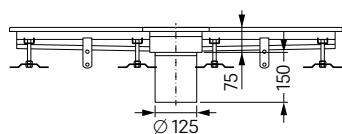
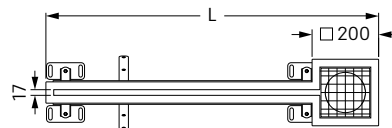
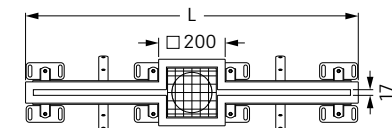
System 125

for installation in a concrete slab

Material: Stainless steel AISI 304, material thickness 2.0 mm, acid-treated in pickling bath, ground visible edges

Version:

- Longitudinal and transverse slopes
- Feet for height adjustment
- Drain pipes in stainless steel
- Load class L 15 (1.5 ton.)



Dimensions W×L×H in mm

Art. no.

with inlet in the middle

17×1000×75, M	61 02 100
17×1400×75, M	61 02 140
17×2000×75, M	61 02 200
17×3000×75, M	61 02 300
17×4000×75, M	61 02 400

with inlet at the end of the channel

17×1000×75, A	61 02 101
17×1400×75, A	61 02 141
17×2000×75, A	61 02 201
17×3000×75, A	61 02 301
17×4000×75, A	61 02 401

Square / rectangular channel drain *Ferrofix* with glue flange

System 125

for installation in a concrete slab, flange height 15 mm

Material: Stainless steel AISI 304, material thickness 2.0 mm, acid-treated in pickling bath, ground visible edges

Version:

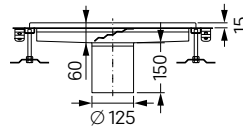
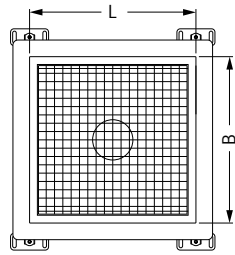
- Longitudinal and transverse slopes
- Feet for height adjustment
- Drain pipes in stainless steel
- Channel profile for shallow bed waterproofing, with adhesive jointing edge 15 mm deep and folded 50 mm outwards, all round, with welded mitring

Cover:

- Slotted cover in stainless steel AISI 304
- Anti-slip R12
- Acid-treated in pickling bath
- Mesh width 23×23 mm
- Load class L 15 (1.5 ton.)

➤ **Optional as accessory:**

Matching drain body System 125 see page 273



Dimensions W×L×H in mm

Art. no.

350× 350×60	60 35 035*
500× 500×60	60 50 050*
500×1000×60	60 50 100*
600× 600×60	60 60 600
800× 800×60	60 80 800*
1000×1000×60	60 00 100*

*available ex stock

Square / rectangular channel drain *Ferrofix* with glue flange

System 125

for installation in a concrete slab, flange height 6 mm

Material: Stainless steel AISI 304, material thickness 1.5 mm, acid-treated in pickling bath, ground visible edges

Version:

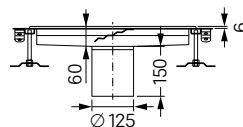
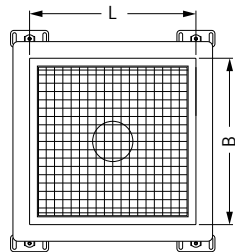
- Longitudinal and transverse slopes
- Feet for height adjustment
- Drain pipes in stainless steel
- Channel profile for connecting to floor coatings (e.g. epoxy resin), with adhesive edge 6 mm deep and 50 mm folded outwards, all round, with welded mitres

Cover:

- Slotted cover in stainless steel AISI 304
- Anti-slip R12
- Acid-treated in pickling bath
- Mesh width 23×23 mm
- Load class L 15 (1.5 ton.)

➤ **Optional as accessory:**

Matching drain body System 125 see page 273



Dimensions W×L×H in mm

Art. no.

350× 350×60	62 35 035
500× 500×60	62 50 050
500×1000×60	62 50 100
600× 600×60	62 60 600
800× 800×60	62 80 800
1000×1000×60	62 00 100

Square / rectangular channel drain *Ferrofix* with tile connection angle

System 125

for installation in a concrete slab

Material: Stainless steel AISI 304, material thickness 2.0 mm, acid-treated in pickling bath, ground visible edges

Version:

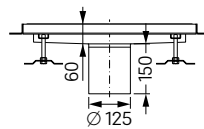
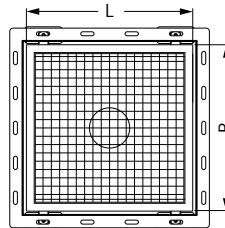
- Longitudinal and transverse slopes
- Feet for height adjustment
- Drain pipes in stainless steel
- Channel profile for connecting to floorings with particularly high thermal exposure, with welded mitres

Cover:

- Slotted cover in stainless steel AISI 304
- Anti-slip R12
- Acid-treated in pickling bath
- Mesh width 23×23 mm
- Load class L 15 (1.5 ton.)

➤ **Optional as accessory:**

Matching drain body System 125 see page 273



Dimensions W×L×H in mm

Art. no.

350× 350×60	63 35 035
500× 500×60	63 50 050
500×1000×60	63 50 100
600× 600×60	63 60 600
800× 800×60	63 80 800
1000×1000×60	63 00 100

Square / rectangular channel drain *Ferrofix* without glue flange

System 125

for installation in a concrete slab

Material: Stainless steel AISI 304, material thickness 2.0 mm, acid-treated in pickling bath, ground visible edges

Version:

- Longitudinal and transverse slopes
- Feet for height adjustment
- Drain pipes in stainless steel
- Channel profile for shallow bed waterproofing, with adhesive jointing edge 15 mm deep and folded 50 mm outwards, all round, with welded mitring

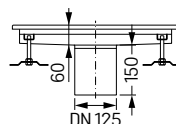
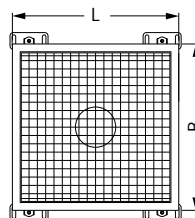
Cover:

- Slotted cover in stainless steel AISI 304
- Anti-slip R12
- Acid-treated in pickling bath
- Mesh width 23×23 mm
- Load class L 15 (1.5 ton.)

Note: available ex stock

➤ **Optional as accessory:**

Matching drain body System 125 see page 273



Dimensions W×L×H in mm

Art. no.

350× 350×60	61 35 035
500× 500×60	61 50 050
500×1000×60	61 50 100
600× 600×60	61 60 600
800× 800×60	61 80 800
1000×1000×60	61 00 100

Modular system

System 125

Ferrofix

Drain bodies System 125

for connection to SML-pipe and removable odour trap



Outer diameter Ø (mm)	B × H (mm)	Art. no.
Ø 58	245 × 120	48 358
Ø 78	134 × 109	48 378
Ø 83	134 × 108	48 383
Ø 110	148 × 92	48 311



Outer diameter Ø (mm)	H (mm)	Art. no.
Ø 58	100	48 458
Ø 78	110	48 478
Ø 83	110	48 483
Ø 110	110	48 411

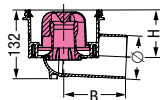
Ecoguss with connection flange

lateral outlet

Material: Ecoguss resistant

Sealing water height: 50 mm

Drainage capacity: 1.5 – 1.7 l/s*



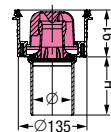
Ecoguss with connection flange

vertical outlet

Material: Ecoguss resistant

Sealing water height: 50 mm

Drainage capacity: 1.5 – 2.1 l/s*



Outer diameter Ø (mm)	Art. no.
Ø 78	54 400
Ø 110	54 420

* Further nominal sizes (e.g. Ø 50, 53, 56, 58, 63, 75, 83, 90) on request or according to requirement



Outer diameter Ø (mm)	Art. no.
Ø 78	54 410
Ø 110	54 430

* Further nominal sizes (e.g. Ø 50, 53, 56, 58, 63, 75, 83, 90) on request or according to requirement

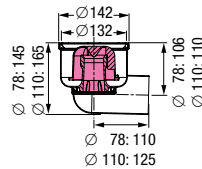
with connection flange

lateral outlet

Material: Stainless steel AISI 304

Sperrwasserhöhe: 50 mm

Drainage capacity: 1.5 – 1.9 l/s*



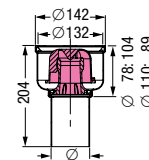
with connection flange

vertical outlet

Material: Stainless steel AISI 304

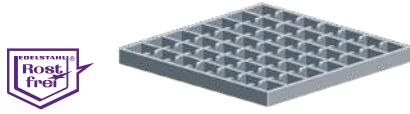
Sperrwasserhöhe: 50 mm

Drainage capacity: 2.0 – 2.4 l/s*



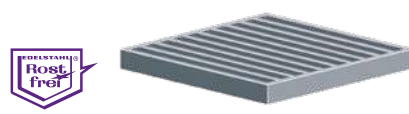
* depending on the upper section used (see page 250 – 251)
 Modular system Ecoguss System 125 (see page 234 – 236)
 Modular system Ferrofix System 125 (see page 254 – 257)

Covers



Cover in stainless steel

Anti-slip R 12, acid-treated in pickling bath
 Mesh width 23×23 mm or 30×30 mm, class L 15 or M 125



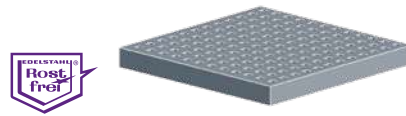
Bar cover in stainless steel

Not anti-slip, acid-treated in pickling bath
 Rod clearance 18 mm, supporting member 25×8 mm, class M 125



Slab cover in stainless steel

Not anti-slip, glass bead-blasted
 All-round 8 mm inlet, material thickness 10 mm, class M 125



Bathroom cover in stainless steel

Suitable for barefoot area, brushed surface, perforation 8×8 mm,
 Insertion depth 25 mm, thickness 2 mm, class K 3



Ribbed plate cover in stainless steel

Anti-slip R 11, acid-treated in pickling bath
 All-round 8 mm inlet
 Material thickness 10 mm, class M 125



Bathroom cover made of polymer

Suitable for barefoot area, with rounded or flat upper profile
 Colours white, grey, beige or yellow (other RAL colours and
 'rollable' grating available on request) Insertion depth 25 mm,
 class K 3

Accessories

System 125

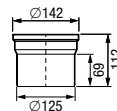
Floor drains *Ferrofix*

Extension sections with connection flange

Art. no.

without lateral inlet

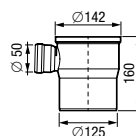
Compatibility: For floor drain *Ferrofix* System 125
Material: Stainless steel AISI 304
Inclusive: Lip seal



54 900

with lateral inlet Ø 50

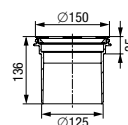
Compatibility: For floor drain *Ferrofix* System 125
Material: Stainless steel AISI 304
Inclusive: Lip seal



54 902

without lateral inlet

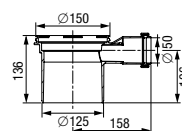
Compatibility: For floor drain *Ferrofix* System 125
Material: PP
Inclusive: Lip seal



48 987

with lateral inlet Ø 50

Compatibility: For floor drain *Ferrofix* System 125
Material: PP
Inclusive: Lip seal



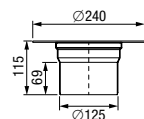
48 989

Extension sections with glue flange

Art. no.

without lateral inlet

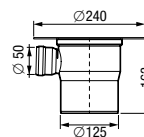
Compatibility: For floor drain *Ferrofix* System 125
Material: Stainless steel AISI 304
Inclusive: Lip seal



54 901

with lateral inlet Ø 50

Compatibility: For floor drain *Ferrofix* System 125
Material: Stainless steel AISI 304
Inclusive: Lip seal



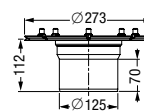
54 903

Extension sections with pressure sealing flange

Art. no.

without lateral inlet

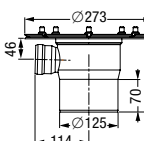
Compatibility: For floor drain *Ferrofix* System 125
Material: Stainless steel AISI 304
Version: Flange width 70 mm



54 187

with lateral inlet Ø 50

Compatibility: For floor drain *Ferrofix* System 125
Material: Stainless steel AISI 304
Version: Flange width 70 mm
Inclusive: Plug-in sleeve Ø 50/40



54 189

Accessories

System 125

Floor drains *Ferrofix*

Fire protection / Passage seal

			Outer diameter Ø (mm)	Art. no.	
Fire-Kit	Compatibility: Only for drain bodies System 125 with vertical outlet and odour trap Function: Fire protection insert DIBt Certification			Ø 58/78/83	48 099
				Ø 50/75	48 099
				Ø 110	48 100
Quick-Fit with fire protection	Compatibility: Only in combination with <i>Fire-Kit</i> protection insert Function: For core drilling for drain body vertical outlet System 125 DIBt Certification		-	48 990	
Quick-Fit without fire protection	Compatibility: For drain body vertical outlet System 125 Function: For core drilling for drain body vertical outlet		-	48 991	

Hygiene and odour stop

				Art. no.
Sludge trap	Compatibility: For floor drain <i>Ferrofix</i> System 125 Material: Stainless steel AISI 304 Note: Additional sizes on demand			48 636
Sludge trap	Compatibility: Fits all drain bodies <i>Ferrofix</i> System 125 Material: Polymer			48 168
Odour trap	Compatibility: For floor drain <i>Ferrofix</i> System 125 Material: Stainless steel AISI 304 Sealing water height: 50 mm			54 188

Accessories


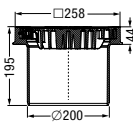
System 200

Floor drains *Ferrofix*






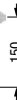



Extension sections

			Art. no.
with connection flange	<p>Compatibility: For floor drain <i>Ferrofix</i> System 200</p> <p>Material: PP</p> <p>Inclusive: Lip seal</p>	 	48 988
with connection flange	<p>Compatibility: For floor drain <i>Ferrofix</i> System 200</p> <p>Material: Stainless steel AISI 304</p> <p>Inclusive: Lip seal</p>	 	27 186
with pressure sealing flange	<p>Compatibility: For floor drain <i>Ferrofix</i> System 200</p> <p>Material: Stainless steel AISI 304</p>	 	27 185

Upper sections

			Art. no.
Shallow bed upper section	<p>Compatibility: For floor drain <i>Ferrofix</i> System 200</p> <p>Material: ABS</p> <p>Cover: Slotted cover 200 × 200 mm and rim in stainless steel AISI 304, screwed, class L 15</p> <p>Inclusive: Waterproofing membrane</p>	 	48 988
with support rim	<p>Compatibility: For floor drain <i>Ferrofix</i> System 200</p> <p>Material: <i>Ecoguss Heavy Duty</i></p> <p>Cover: Round slotted cover Ø 235 mm class B 125, with <i>Lock & Lift</i> System</p>	 	67 985

Hygiene / odour stop / security

			Art. no.
removable odour trap	<p>Compatibility: For floor drain <i>Ferrofix</i> System 200</p> <p>Material: Stainless steel AISI 304</p> <p>Sealing water height: 70 mm</p>	 	27 182
Sludge trap	<p>Compatibility: For floor drain <i>Ferrofix</i> System 200</p> <p>Material: Stainless steel AISI 304</p> <p>Height: 60 mm</p>	 	67 302
Sludge trap	<p>Compatibility: For floor drain <i>Ferrofix</i> System 200</p> <p>Material: Stainless steel AISI 304</p> <p>Height: 150 mm</p>	 	67 301
Sludge trap	<p>Compatibility: For floor drain <i>Ferrofix</i> System 200</p> <p>Material: PE-HD</p>	 	67 300
Access key	<p>Compatibility: For Art. no. 48 954-S-V2A-KF</p> <p>Material: Stainless steel AISI 304</p>		48 954-SL

Accessories

Floor drains *Ferrofix*

System 100

System 125

System 200

Fire protection insert

Art. no.

Fire-Kit 200

Compatibility: Only for drain bodies with vertical outlet and odour trap
Certification no.: Z-19.17-1719



48 200

Sludge trap system 100

up to 158 mm width

Art. no.

Height 39 mm

Compatibility: For box channel *Ferrofix*
Material: Stainless steel AISI 316L



67 304

Height 39 mm

Compatibility: For box and slotted channels *Ferrofix*
Material: Stainless steel AISI 316L



67 305

Height 90 mm

Compatibility: For stainless steel channels *Ferrofix*
Material: Stainless steel AISI 304
Note: Not for drainage channels *Ferrofix Express*



6101SKH

Sludge trap system 125

up to 200 mm width

Art. no.

Height 31 mm

Compatibility: For stainless steel channels *Ferrofix*
Material: Stainless steel AISI 304



48 636

Height 90 mm

Compatibility: For stainless steel channels *Ferrofix*
Material: Stainless steel AISI 304



6125SKH

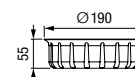
Sludge trap system 200

up to 300 mm width

Art. no.

Height 55 mm

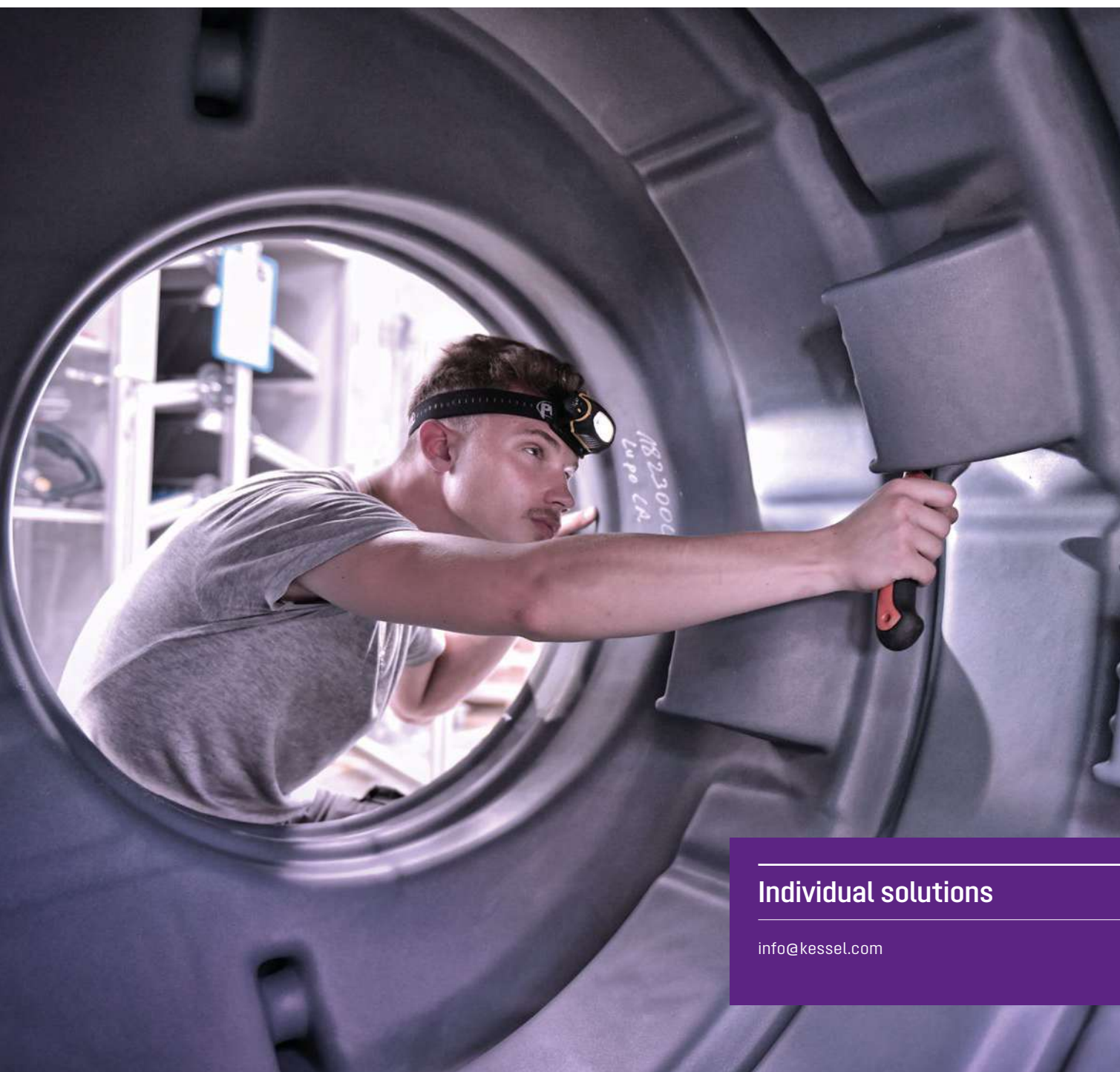
Compatibility: For stainless steel channels *Ferrofix*
Material: Stainless steel AISI 304



6200SKN

Not found what you're looking for?

In addition to our standard backwater protection devices we also develop customised solutions meeting your exact specifications.



Floor drains

4.2

Individual solutions

info@kessel.com

4.3 Basement drains

High flow, heavy-duty construction,
available with integrated backwater protection



Backwater pumping station *Pumpfix S*

The Special solution with backwater valve and pump.

Stronger than the backwater: The *Pumpfix S* is the only basement drain with backwater valve, which pumps against backwater. It normally drains sewage free wastewater to the sewer by gravity – even handles incoming flood water or flooding from a burst water supply pipe. Yet it shows its true strength in case of backwater: The pump then switches on automatically and pumps the building's wastewater into the flooded sewer. It is also ideally suitable for draining outdoor basement stairs.

The *Pumpfix S* is available in two models: a compact version with polymer grating, which is particularly suitable for renovation projects, and a larger version with multiple inlet connections and a tileable cover.



Installation in waterproof concrete

The KESSEL sealing kit for installation in waterproof concrete ensures reliable protection against moisture damage. The extension section with central flange and elastomeric waterproofing membrane can also be used for deeper installation.

Additional inlet connections

In addition to the cover with integrated inlet several lateral inlets can also be attached, for a shower, washing machine and wash-basin. The *Pumpfix S* basement drain can therefore also be used as central backwater protection.

Backwater pumping station *Pumpfix S*

For installation in a concrete floor/slab



According to EN 13564 Type 5

Made of polymer. With lateral outlet 2.5°, removable pump, twin flap backwater valve and odour trap, Drainage capacity 1.6 l/sec flow rate. For installation depth (D) from 330 – 460 mm. Installation area 600×600 mm

Twin flaps, self-closing, one of which can be locked by hand, self activating pump during backwater (pumps against 0.7 bar = 7 m water column) cable length 5 m. With telescopic upper section for height and level adjustments

Cover:

With black / recessed cover for on-site tiling, integrated drain, made of polymer, class K 3.

With moisture protective sealing flange.

Note: Not for use as a lifting station

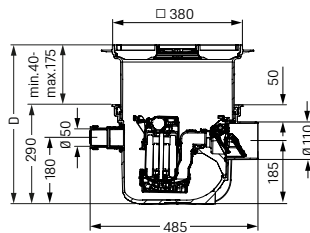
Accessories: see pages 296 – 300



Illustration shows Art. no. 280 451X

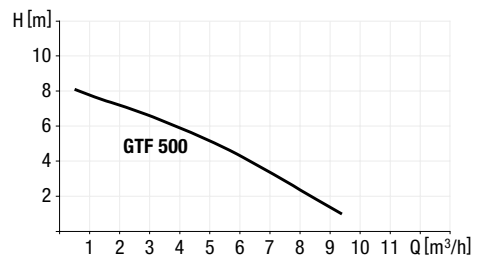


Illustration shows Art. no. 280 451S



Outer diameter Ø (mm)	GTF pump	Voltage	Art. no.
With recessed cover for on-site tiling			
Ø 110	500-S1	230 V	280 451X
With black cover			
Ø 110	500-S1	230 V	280 451S

Pumping capacity



Backwater valve *Universale Plus*

More advantages, less hassle with an extra measure of innovation: this plan works out! On the following pages you will find out how the *Universale Plus* basement drain with integrated backwater valve and odour trap makes it even easier for you to drain basement rooms in future.

But that's not all. Also discover why you not only save time but also save money with the *Universale Plus* – from the design to the installation through to maintenance.



The installation is also possible without waterproofing where high groundwater is not an issue



With *Ecoguss* upper section for up to 12.5 tonne loads



Installation with waterproofing against groundwater



+ Variable upper sections can be rotatable, tilted and adjusted vertically

Extension section
extension section with three inlets Ø 50



+



+ Backwater unit or odour trap for tool-free installation

Universale Plus drain body
Versions with backwater valve including odour trap or only odour trap

+



+ Waterproof sealing flange (MFPA Leipzig tested) factory-mounted or available as optional accessory

Universale Plus basement drain

with backwater valve



EN 13564 Type 5

The polymer *Universale Plus* basement drain is equipped with a removable backwater valve with two backwater flaps, one hand-lockable emergency closure and a sludge bucket.

Material: PP

Version includes:

- vertical outlet, Ø 110
- with backwater valve
- odour trap
- sludge bucket

Cover:

- Slotted cover 187×187mm and frame made of 304 stainless steel, screwed, class K 3

Sealing water height: 60 mm

Drainage capacity with backwater valve: 1.7 L/s

Cut-out dimensions: 310×310 mm

➤ **Accessories:** pages 296 – 300

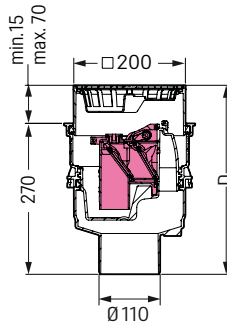


Fig.: Article 27 671

With twin flap backwater valve

according to EN 13564 Type 5

Outer diameter Ø (mm)	Installation depth D in mm	Art. no.
With stainless steel cover		
Ø 110	293 - 350	27 671

Universale Plus basement drain

with water pressure-tight sealing flange, with / without backwater valve



EN 13564 Type 5

The polymer *Universale Plus* is equipped with/without a removable backwater valve with two backwater flaps, one hand-lockable emergency closure and a sludge bucket.

Material: PP

Version includes:

- vertical outlet, Ø 110
- factory-mounted flange for installation in waterproof concrete
- with/without backwater valve
- odour trap
- sludge bucket

Cover:

- Slotted cover 188×188 mm made of polymer, black, Class K 3
- Slotted cover 187×187 mm and frame made of 304 stainless steel, screwed, class K 3

Sealing water height: 60 mm

Drainage capacity with backwater valve: 1.9 L/s

Drainage capacity without backwater valve: 2.5 L/s

Cut-out dimensions: 310×310 mm

➤ **Accessories:** pages 296 – 300

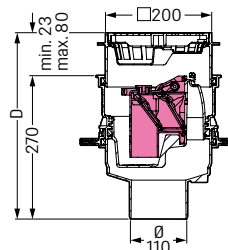


Fig.: Article 27 631

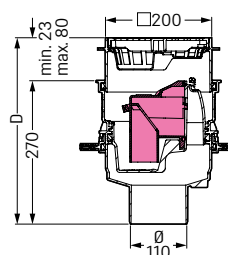


Fig.: Article 29 131

With twin flap backwater valve

according to EN 13564 Type 5

Outer diameter Ø (mm)	Installation depth D in mm	Art. no.
With black cover		
Ø 110	293 - 350	27 631
With stainless steel cover		
Ø 110	293 - 340	27 641

Without twin flap backwater valve

Outer diameter Ø (mm)	Installation depth D in mm	Art. no.
With black cover		
Ø 110	293 - 350	29 131
With stainless steel cover		
Ø 110	293 - 340	29 141

Universale Plus basement drain

with water pressure-tight sealing flange, with / without backwater valve



EN 13564 Type 5

The polymer *Universale Plus* basement drain is used for drainage of wastewater without sewage and is equipped with/without a removable backwater valve with two backwater flaps and a hand-lockable emergency closure. Including temporary protective cover.

Material: PP

Version includes:

- vertical outlet, Ø 110
- with *Variofix* upper section for combined waterproofing and enclosed waterproofing membrane to DIN 18534-1-W3-I
- factory-mounted flange for installation in waterproof concrete
- with/without backwater valve
- odour trap

Cover:

- Slotted cover 187 × 187 mm and frame made of 304 stainless steel, screwed, class K 3

Sealing water height: 60 mm

Drainage capacity with backwater valve: 1.7 L/s

Drainage capacity without backwater valve: 2.3 L/s

Cut-out dimensions: 310 × 310 mm

➤ **Accessories:** pages 296 – 300



With twin flap backwater valve

according to EN 13564 Type 5

Outer diameter Ø (mm)	Installation depth D in mm	Art. no.
Ø 110	309 – 408	27 651

Without twin flap backwater valve

Outer diameter Ø (mm)	Installation depth D in mm	Art. no.
Ø 110	309 – 408	29 151

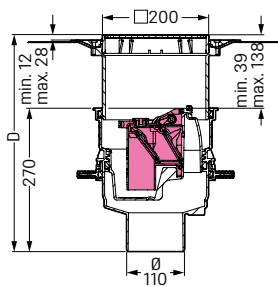


Fig.: Article 27 651

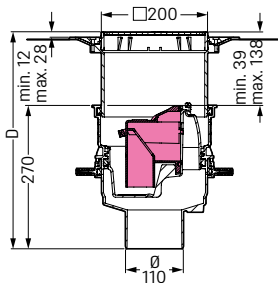


Fig.: Article 27 151

Backwater valve *The Universal*

The versatile drain with backwater valve.

It couldn't be more flexible. *The Universal* is a versatile basement drain for sewage free wastewater. It is equipped with a backwater valve and a manually lockable emergency closure. *The Universal* has three inlets as a standard feature (two in Ø 50 and one in Ø 75 mm), the telescopic upper section is also rotatable, tiltable and height-adjustable. This ensures it provides maximum flexibility for the design and installation. *The Universal* is optionally available with a slotted grating made of polymer or stainless steel.



1 Drain 2 Inlet 3 Steel cover

Backwater valve *The Universal*

For installation in a concrete floor/slab



CE EN 13564 Type 5

Made in PP. With lateral outlet 2.5°, 2 inlets Ø 50, 1 inlet Ø 75 mm with blind plug, odour trap and sludge trap.

With/without twin flap backwater valve.

Drainage capacity 1.8 l/sec flow rate.

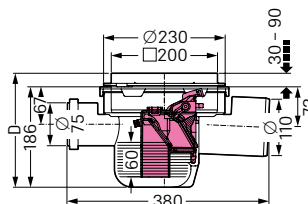
Sealing water height 60 mm.

Installation area 400 × 320 mm

Cover:

Slotted cover 188 × 188 mm made of polymer, black, class K 3;

slotted cover 187 × 187 mm and rim made of stainless steel AISI 304, screwed, class L 15



With twin flap backwater valve

according to EN 13564 Type 5

Outer diameter Ø (mm)	Installation depth D in mm	Art. no.
--------------------------	-------------------------------	----------

With black cover

Ø 110	216 - 276	27 611
-------	-----------	--------

With stainless steel cover

Ø 110	216 - 266	27 621
-------	-----------	--------

Without twin flap backwater valve

Outer diameter Ø (mm)	Installation depth D in mm	Art. no.
--------------------------	-------------------------------	----------

With black cover

Ø 110	216 - 276	29 111
-------	-----------	--------

With stainless steel cover

Ø 110	216 - 266	29 121
-------	-----------	--------

➤ Accessories: pages 296 - 300

Backwater valve *Drehfix*

The compact drain for renovation.

The *Drehfix* is a basement drain with integrated, removable backwater valve (Type 5). In addition, it protects connected discharge points such as washbasins, showers or washing machines against wastewater from the sewer. With odour trap, sludge bucket, manually locked emergency closure and a discharge rate of 1.8 l/s, it can be used flexibly and is so compact that it fits in the recesses of old cast iron drains. It is therefore ideally suitable for renovation projects.



1 Drain 2 Inlet

Backwater valve *Drehfix*

For installation in a concrete floor/slab



CE EN 13564 Type 5

Made in ABS. With lateral outlet 2.5°, with/without removeable twin flap backwater valve and emergency closure which can be locked by hand, odour trap and sludge trap and integrated, height adjustable upper section.

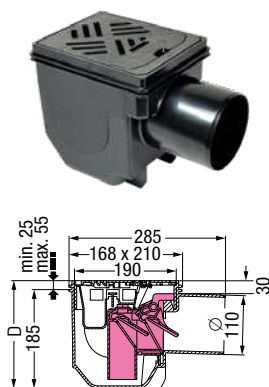
Drainage capacity 1.8 l/sec flow rate.

Sealing water height 60 mm.

Installation area 320 × 190 mm

Cover:

Slotted cover 150 × 190 mm made of polymer, black, with Easy Entry Function, class K 3



Outer diameter Ø (mm)	Installation depth D in mm	Art. no.
With twin flap backwater valve according to EN 13564 Type 5		
Ø 110	210 - 240	27 301
Without twin flap backwater valve		
Ø 110	210 - 240	33 101

➤ **Accessories:** pages 296 – 300

Basement drains with integrated volatile liquid trap

Basement drainage with integrated oil / fuel trap and available backwater protection.

Perfect for the heating room in the basement: Surface water passes through a polymer slotted grating and into the light liquid trap where it is discharged into the sewer. If a volatile liquid, for example, heating oil gets into the drain, a floater reliably ensures that contaminated wastewater is not transported into the sewer and cannot cause serious pollution in the sewer and connected wastewater treatment plants. Available in two variants, with and without integrated double backwater valve.



1 Volatile liquid trap 2 Integrated floater 3 Upper section

How it works

The basement drain not only prevents wastewater contaminated with light liquids from getting into the sewer, but also prevents wastewater pushed back from the sewer (backwater) from getting into the basement.

Volatile liquid trap

For installation in a concrete floor/slab



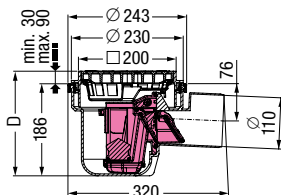
EN 13564 Typ 5

Made in polymer. With twin flap backwater valve, with integrated odour trap and sludge trap. Drainage capacity 1.0 l/sec flow rate. Sealing water height 50 mm. Installation area 400×250 mm

Cover:

Slotted cover 188×188 mm made of polymer, black, class K 3

➤ **Accessories:** pages 296 – 300



Outer diameter Ø (mm)	Installation depth D in mm	Art. no.
Ø 110	216 - 276	52 101

Volatile liquid trap

For installation in a concrete floor/slab



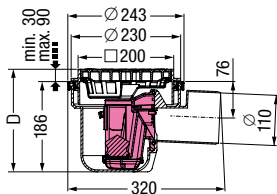
EN 1253-5

Made in polymer. With integrated odour trap and sludge trap. Drainage capacity 1.0 l/sec flow rate. Sealing water height 50 mm. Installation area 400×250 mm

Cover:

Slotted cover 188×188 mm made of polymer, black, class K 3

➤ **Accessories:** pages 296 – 300



Outer diameter Ø (mm)	Installation depth D in mm	Art. no.
Ø 110	216 - 276	51 101



Basement drains without backwater valve

The drain for uncomplicated applications.

Basement drains without backwater valves are ideally suitable for basements that lie above the backwater level, meaning they are not at risk of backwater flooding. We supply our basement drains without backwater valves with or without odour trap and / or sludge bucket as well as with lateral or vertical outlet.

Odour trap

We offer different drains with integrated odour traps to protect against unpleasant odours from the sewer. Many drains can also be equipped with our Multistop waterless odour trap, whose tightly sealing flap provides additional protection against foam and vermin.

Basement drain *Practicus*

For installation in a concrete floor / slab



EN 1253-1

Made in PP. With removable odour trap, with lip seal and protective cover or use during construction.

Drainage capacity in l/sec with 20 mm / 10 mm threshold 1.6 l/sec / 1.1 l/sec.

Installation area:

lateral outlet: 220 × 180 mm

vertical outlet: 180 × 180 mm

With upper section in ABS

Cover:

Slotted cover 138 × 138 mm in ABS, black, class K 3

➤ **Accessories:** page 296 – 300



Illustration shows Art. no. 45 110.40 (lateral outlet)

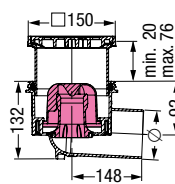


Illustration shows Art. no. 45 110.40 (lateral outlet)

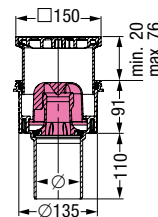


Illustration shows Art. no. 45 210.40 (vertical outlet)



Outer diameter Ø (mm)	Art. no.
Lateral outlet	
Ø 110	45 110.40
Vertical outlet	
Ø 110	45 210.40

Basement drain *Practicus*

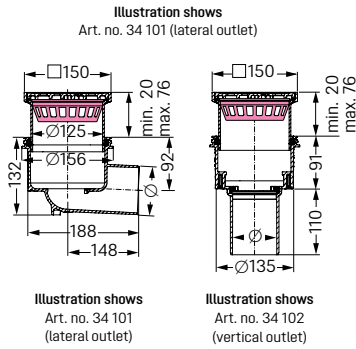
For installation in a concrete floor / slab

Made in PP. With sludge trap, with lip seal and protective cover for use during construction. Drainage capacity in l/sec with 20 mm / 10 mm threshold 1.8 l/sec / 1.1 l/sec. Installation area:
 lateral outlet: 220×180 mm
 vertical outlet: 180×180 mm
 With upper section in ABS

Cover:

Slotted cover 138×138 mm in ABS, black, class K 3

➤ **Accessories:** page 296 – 300



Outer diameter Ø (mm)	Art. no.
Lateral outlet	
Ø 110	34 101
Vertical outlet	
Ø 110	34 102

Basement drain

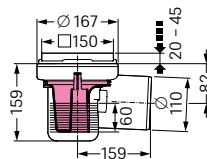
For installation in a concrete floor / slab

Made in PP. Lateral outlet 2.5°, with removable odour trap and sludge trap. Drainage capacity 1.6 l/sec flow rate. Installation area 220×280 mm
 With upper section in PP

Cover:

Slotted cover 138×138 mm made in polymer, black, class K 3

➤ **Accessories:** page 296 – 300



Outer diameter Ø (mm)	Art. no.
Ø 110	36 501

Modular system

Universale Plus / The Universal / Volatile liquid trap / Basement drains without backwater valve

Drain bodies



New

Art. no.

27 650

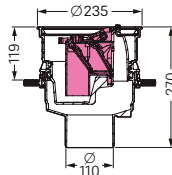
Universale Plus

with backwater valve and waterproof flange

Material: PP

Version:

factory-mounted flange for installation in waterproof concrete, water pressure tight up to 0.6 bar and radon tight



New

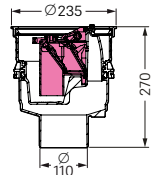
Art. no.

27 660

Universale Plus

with backwater valve without waterproof flange

Material: PP



New

Art. no.

29 102

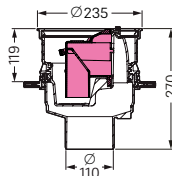
Universale Plus

with odour trap and waterproof flange

Material: PP

Version:

factory-mounted flange for installation in waterproof concrete, water pressure tight up to 0.6 bar and radon tight



New

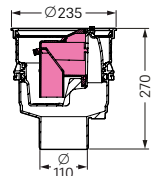
Art. no.

29 103

Universale Plus

with odour trap without waterproof flange

Material: PP



Outer diameter Ø (mm)

Ø 110

Art. no.

27 600

The Universal

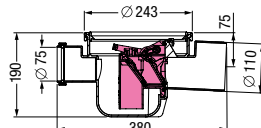
with backwater valve

Material: PP

Version: 2 inlets Ø 50,

1 inlet Ø 75 with blind plug

Compatibility: Art. no. 27 611, 27 621



Outer diameter Ø (mm)

Ø 110

Art. no.

29 101

Basement drain

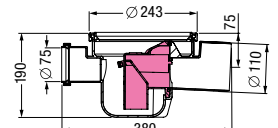
with odour trap

Material: PP

Version: 2 inlets Ø 50,

1 inlet Ø 75 with blind plug

Compatibility: Art. no. 29 111, 29 121



Outer diameter Ø (mm)

Ø 110

Art. no.

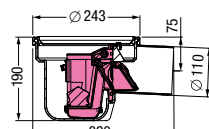
52 102

Volatile liquid trap

with backwater valve

Material: Polymer

Compatibility: Art. no. 52 101



Outer diameter Ø (mm)

Ø 110

Art. no.

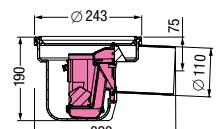
51 102

Volatile liquid trap

with odour trap

Material: Polymer

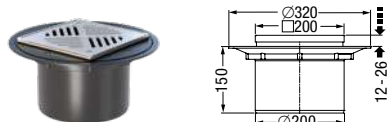
Compatibility: Art. no. 51 101



Modular system

Universale Plus / The Universal / Volatile liquid trap / Basement drains without backwater valve

Upper section with slotted cover



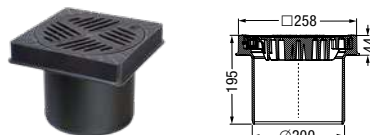
Variofix shallow bed upper section

in ABS

Cover: Slotted cover and rim in stainless steel AISI 304, screwed, class K 3

Inclusive: Waterproofing membrane

Art. no. 48 968



in *Ecoguss Heavy Duty*

Version: Upper section with support rim 250 × 250 mm, height adjustable

Cover: Round slotted cover in *Ecoguss*, Ø 235 mm, class B 125, *Lock & Lift* System

Art. no. 67 985



in ABS

Cover: Slotted cover and rim in stainless steel AISI 304, screwed, class K 3

Art. no. 48 954



in ABS

Cover: Slotted cover in ABS, black, class K 3

Art. no. 48 964

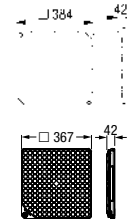
Accessories

Pumpfix S

Cover plates

surface water tight

Compatibility:
For backwater pumping station *Pumpfix S*
Inclusive: Gasket
Version recessed for on-site tiling, grey:
For tile thicknesses of 18 mm
(Ventilation always required when in use!)

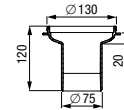


Cover	Art. no.
tileable	830 052
black	830 050

Hygiene and odour stop

Drain body

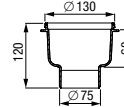
Compatibility: For lowest installation;
for backwater pumping station *Pumpfix S*



Cover	Art. no.
black	680 796
grey	680 798

Drain body

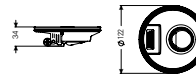
Compatibility: Seal water height 50 mm;
for backwater pumping station *Pumpfix S*



black	680 795
grey	680 797

To be ordered additionally *Multistop*

Compatibility: For backwater pumping station *Pumpfix S*
Function: Odour, foam, rodent and insect stop



48 500

To be ordered additionally *Megastop*

Compatibility: For backwater pumping station *Pumpfix S*
Function: Mechanical odour trap inclusive hair filter for KESSEL upper sections



48 550

To be ordered additionally odour trap

Compatibility: For backwater pumping station *Pumpfix S*
Seal water height: 50 mm
(Ventilation always required when in use!)



680 696

Hygiene

Hair filter

Compatibility: Art. no. 48 500;
for backwater pumping station *Pumpfix S*



Art. no.

48 700

Accessories

Pumpfix S, Universale Plus, The Universal, Practicus and volatile liquid traps

Extension sections

with centre flange	<p>Compatibility: For backwater pumping station <i>Pumpfix S</i></p> <p>Additional function: For installation in waterproof concrete</p> <p>Including sealing set: Counter flange in stainless steel, screwed, elastomer sealing sheet made of NK/SBR Ø 700 mm</p> <p>Extension: Max. 294 mm</p>			Art. no. 830 075
---------------------------	--	---	--	----------------------------

with flange and counter flange	<p>Compatibility: For backwater pumping station <i>Pumpfix S</i></p> <p>Additional function: For connection to an on-site sealing sheet</p> <p>Inclusive: Gasket</p> <p>Extension: Max. 147 mm (In case of deeper installation ensure maintenance capability!)</p>			Art. no. 830 073
---------------------------------------	--	---	--	----------------------------

with flange	<p>Compatibility: For backwater pumping station <i>Pumpfix S</i></p> <p>Additional function: For deeper installation</p> <p>Inclusive: Gasket</p> <p>Extension: Max. 147 mm (In case of deeper installation ensure maintenance capability!)</p>			Art. no. 830 070
--------------------	---	---	--	----------------------------

with three lateral inlets	<p>Material: PP</p> <p>Inclusive: Lip seal and blind plug</p> <p>Height: 175 mm</p>			Art. no. 48 966
----------------------------------	--	---	--	---------------------------

without lateral inlet	<p>Compatibility: For basement drain <i>The Universal</i> and volatile liquid traps</p> <p>Material: PP</p> <p>Inclusive: Lip seal</p> <p>Height: 175 mm</p>			Art. no. 48 988
------------------------------	--	---	--	---------------------------

without lateral inlet	<p>Compatibility: For basement drain <i>Practicus</i></p> <p>Material: PP</p> <p>Inclusive: Lip seal</p>			Art. no. 48 987
------------------------------	---	---	--	---------------------------

Extension section

with pressure sealing flange and counter flange	<p>Inclusive: Waterproofing layer against ground moisture</p> <p>Height: 150 mm</p>			Art. no. 27 298
--	---	---	--	---------------------------

Waterproofing membrane	<p>Compatibility: Art. no. 27 298</p>		Art. no. 48 651
-------------------------------	--	---	---------------------------

2 component adhesive	<p>Compatibility: For gluing of KESSEL waterproofing membranes</p>		Art. no. 48 650
-----------------------------	---	---	---------------------------

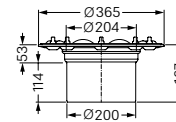
Accessories

Universale Plus, The Universal, Drehfix, Practicus, volatile liquid traps and Art. no. 36 501

Extension section in *Ecoguss resistant*

with pressure sealing flange and counter flange

Additional function: For installation in waterproof concrete
Height: 166 mm



Art. no.

48 958

Elastomer waterproof membrane

Compatibility: Art. no. 48 958
Material: NBR

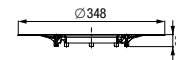


48 982

Flanges

Glue flange with counter flange

Compatibility: For basement drain *Practicus*
Material: ABS

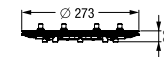


Art. no.

48 410

Pressure sealing flange

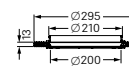
Compatibility: For basement drain *Practicus*
Material: Stainless steel AISI 304



48 407

Waterproof flange

Compatibility: For basement drain *Universale Plus*
Art. no. 27 660, 29 103
Material: PP



48 967

Elastomer waterproof membrane

Membrane

Compatibility: Art. no. 48 407
Material: NBR



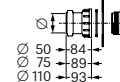
Art. no.

48 981

Inlet adaptor

Inlet adaptor

Compatibility: For basement drain *Drehfix*
Inclusive: Flat seal



**Outer diameter
Ø (mm)**

**Drill size
in mm**

Art. no.

Ø 50

60

39 005

Ø 75

92

39 007

Ø 110

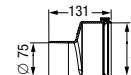
121

39 100

Transition section

Transition section

Compatibility: For basement drain *The Universal, Drehfix* and Art. no. 36 501
Inclusive: Ø 110 socket / Ø 75 spigot for use as connection piece, gasket



**Outer diameter
Ø (mm)**

Art. no.

Ø 75/110

27 602

Rodent protection

Rodent protection

Compatibility: For basement drain *The Universal, Drehfix* and volatile liquid traps
Material: Stainless steel



Art. no.

27 609

Accessories

The Universal, Drehfix, Practicus and Art. no. 36 501

Twin-flap backwater protection insert

with integrated odour trap

Compatibility: For basement drain *The Universal* with twin flap backwater valve
Inclusive: Odour trap (62 mm)

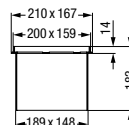


Art. no.
27 603

Extension section / slotted cover / sludge trap

Extension section

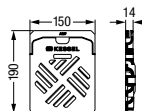
Compatibility: For recessed installation; for basement drain *Drehfix*
Height: 183 mm



Art. no.
38 670

Slotted cover

Compatibility: For basement drain *Drehfix*
Version: Class K 3, with recessed handle for cover removal



27 205

Sludge trap

Compatibility: For basement drain *Drehfix*
Version: With integrated handle for removal

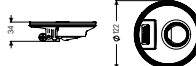


27 308

Hygiene and odour stop

Multistop

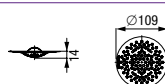
Compatibility: For basement drain *Practicus*
Function: Odour, foam, rodent and insect stop



Art. no.
48 500

Hair filter

Compatibility: For basement drain *Practicus*
Material: Polymer



48 700

Bell-shaped odour trap insert

Compatibility: For basement drain *Practicus*
Sealing water height: 50 mm



27 169

Sludge trap

Compatibility: For basement drain *Practicus*
Material: Polymer

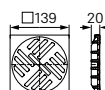


48 168

Slotted cover / upper section / extension section

Slotted cover

Compatibility: For basement drain Art. no. 36 501
Material: ABS
Version: Class K 3



Art. no.
60 101S

Upper section

Compatibility: For basement drain Art. no. 36 501
Material: PP



27 157

Extension section

Compatibility: For basement drain Art. no. 36 501
Material: Polymer
Extension: Can be extended by 80 mm



36 590

Accessories

Pumpfix S, The Universal, Drehfix, volatile liquid traps and Art. no. 36 501

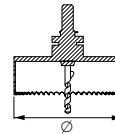
Pipe entrance seals

		Nominal pipe diameter in mm	Outer pipe diameter in mm	Art. no.
Pipe sealing gasket	Compatibility: For backwater pumping station <i>Pumpfix S</i> Requires hole size: Ø 50: 60 mm Ø 75: 92 mm Ø 110: 121 mm	DN 50	Ø 50	850 114
		DN 70	Ø 75	850 116
		DN 100	Ø 110	850 117



Hole saw

		Outer pipe diameter in mm	Drill size in mm	Art. no.
Hole saw set	Compatibility: For backwater pumping station <i>Pumpfix S</i> ; for basement drain <i>The Universal, Drehfix</i> ; Art. no. 36 501 and volatile liquid traps Inclusive: Saw blade holder	Ø 50	60	500 101
		Ø 75	92	
		Ø 110	121	



Not found what you're looking for?

In addition to our standard stainless steel drains and channels we also develop customised solutions at customer request for special demands on form, function and dimensioning.



Basement drains

4.3

Individual solutions

info@kessel.com

4.4 Outdoor drains

Heavy-duty applications

Parking deck drains

The load bearers made of *Ecoguss Heavy Duty*.

An innovation that sets standards: For parking deck drains we use our *Ecoguss Heavy Duty* high-tech composite, which combines the specific advantages of polymer and metal and is an economic and easy to install alternative to drains made of grey cast iron. At the same time, parking deck drains made of *Ecoguss Heavy Duty* offer large advantages with regard to hygiene as well as fire protection and sound insulation and are extremely load resistant and break-proof. They are therefore ideally suitable for use in underground car parks, multi-storey car parks and industrial buildings.



1 Upper section 2 Sealing flange 3 Connection to SML-pipe

Break-proof & load resistant

Our parking deck drains made of *Ecoguss Heavy Duty* are break-proof and fulfil the requirements for load class B 125. They can therefore be loaded with up to 12.5 tonnes and can be easily driven on by cars or pick-up trucks.

Highest fire protection standards

In case of fire, water outlets constitute a risk, as the fire can pass through the discharge pipes and spread to other parts of the building. Our drains can be equipped with the *Fire-Kit* fire and smoke protection insert or the *Quick-Fit* passage seal with integrated fire protection. As soon as fire penetrates the drain body, the fire protection compound inside swells automatically and seals the pipe socket against flames and smoke. Not only the *Fire-Kit* but also the *Quick-Fit* fulfil the highest fire rating R 120.

Resistance, convenience, cleanliness – all these are offered by *Ecoguss Heavy Duty* - our high-tech composite.

➤ Floor/roof drain *Ecoguss*: page 232

Parking deck drain *Ecoguss*

with pressure sealing flange in stainless steel AISI 304

System 125



Made in *Ecoguss Heavy Duty*. Vertical outlet, for connection to SML-pipe according to EN 877, with sludge trap.

Drainage capacity 4.5 l/sec flow rate.

Installation area 300×300 mm

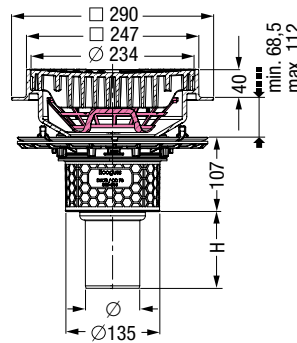
With pressure sealing flange in stainless steel AISI 304, with square upper section in *Ecoguss Heavy Duty* with connection flange 247×247 mm

Cover:

Round slotted cover Ø 234 mm, class B 125 (12.5 to), with *Lock & Lift System*

Note:

Core drilling only Ø 160 mm with *Quick-Fit*



Outer diameter Ø (mm)	Height H in mm	Height H1 in mm	Art. no.
System 125			
Ø 78	110	-	48 878.01
Ø 110	110	-	48 811.01

Parking deck drain *Ecoguss*

square or round

System 100

System 125

Made in *Ecoguss Heavy Duty*. Vertical outlet, for connection to SML-pipe according to EN 877, with sludge trap.

Drainage capacity 4.5 l/sec flow rate.

Installation area 300×300 mm

With square (247×247 mm) or round (Ø 247 mm) upper section in *Ecoguss Heavy Duty* with connection flange

in *Ecoguss Heavy Duty* with connection flange

Cover:

Round slotted cover Ø 234 mm, class B 125 (12.5 to), with *Lock & Lift System*

Note:

Can be used as single piece pipe connection drain!



Illustration shows Art. no. 48 502

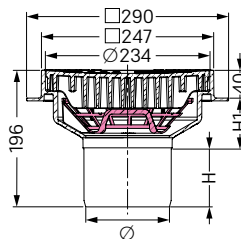


Illustration shows Art. no. 48 501, 48 502

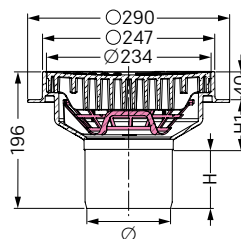


Illustration shows Art. no. 48 503, 48 504

Outer diameter Ø (mm)	Height H in mm	Height H1 in mm	Art. no.
System 100 (SML-pipe) with square upper section			
Ø 110	77	79	48 501
System 125 (plastic pipe) with square upper section			
Ø 125	83	73	48 502
System 100 (SML-pipe) with round upper section			
Ø 110	77	79	48 503
System 125 (plastic pipe) with round upper section			
Ø 125	83	73	48 504

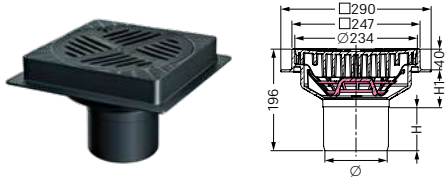
Modular system 100 / 125

System 100

System 125

Parking deck drains *Ecoguss*

Upper section with connection flange



with square upper section

Material: *Ecoguss Heavy Duty*

Class: B 125

Upper section: 247×247 mm

Slotted cover: Ø 234 mm

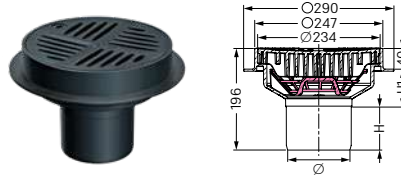
Drainage capacity: 4.5 l/sec flow rate

Inclusive: *Lock & Lift System*, sludge trap

Compatibility: Ø 110 not in combination with drain body *Ecoguss*

Note: Can be used as single piece pipe connection drain!

System 100 (SML-pipe)	Ø 110	H 77 mm	H1 83 mm	Art. no. 48 501
System 125 (plastic pipe)	Ø 125	H 79 mm	H1 73 mm	Art. no. 48 502



with round upper section

Material: *Ecoguss Heavy Duty*

Class: B 125

Upper section: Ø 247 mm

Slotted cover: Ø 234 mm

Drainage capacity: 4.5 l/sec flow rate

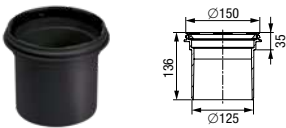
Inclusive: *Lock & Lift System*, sludge trap

Compatibility: Ø 110 not in combination with drain body *Ecoguss*

Note: Can be used as single piece pipe connection drain!

System 100 (SML-pipe)	Ø 110	H 77 mm	H1 83 mm	Art. no. 48 503
System 125 (plastic pipe)	Ø 125	H 79 mm	H1 73 mm	Art. no. 48 504

Accessories

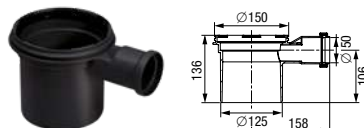


Extension section

Material: PP

Inclusive: Lip seal

without lateral inlet **Art. no. 48 987**



Extension section

Material: PP

Inclusive: Lip seal

with lateral inlet Ø 50 **Art. no. 48 989**



Bell-shaped odour trap insert

Material: PP

Sealing water height: 50 mm

Art. no. 27 169



Fire-Kit Fire protection insert

Only for *Ecoguss* drains with vertical outlet and odour trap Art. no. 27 169

DIBt Certification

Ø 58/78/83 **Art. no. 48 099**

Ø 110 **Art. no. 48 100**



Quick-Fit the passage seal

The all-round seal for core drillings for *Ecoguss* drain body, vertical outlet (only use Art. no. 48 990 in combination with *Fire-Kit* fire protection insert)

***DIBt Certification**

without fire protection **Art. no. 48 991**

with fire protection* **Art. no. 48 990**



Insulating body

fits all *Ecoguss* drain bodies with vertical outlet

Art. no. 48 952

Drain body *Ecoguss*

without odour trap



with pressure sealing flange

Version: High temperature resistant

Sealing water height: 50 mm

Drainage capacity: 4.5 l/sec flow rate

Ø 78 H 110 mm **Art. no. 48 879**

Ø 83 H 110 mm **Art. no. 48 889**

Ø 110 H 110 mm **Art. no. 48 812**

Yard drains

The load resistant drain for outdoor use.

We supply yard drains not only made of polymer but also made of *Ecoguss Heavy Duty*, our high-tech composite, which combines the specific advantages of polymer and metal. They are available in different load classes and can be driven on by vehicles weighing up to 40 tonnes.



- 1 System 400 drain body
- 2 Height-adjustable upper section with cover
- 3 Sludge basket

Break-proof & load resistant

Our yard drains are absolutely break-proof and fulfil different load classes up to D. They can therefore be loaded with up to 40 tonnes and can be easily driven on by cars and/or trucks.

Flexible installation options

Thanks to their unique rotatable, tiltable and up to 350 mm height-adjustable telescopic upper sections, our yard drains can be adjusted exactly to the required ground level.



- 1 Yard drain *Ecoguss*
- 2 Sludge basket
- 3 Locking system

Yard drain *Ecoguss*

pipe connection drain - square / round

Made in *Ecoguss Heavy Duty*.
Vertical outlet, with sludge trap.
Drainage capacity 4.5 l/sec flow rate.
With square (247×247 mm) or
round (Ø 247 mm) upper section
in *Ecoguss Heavy Duty*

Cover:

Round slotted cover Ø 235 mm,
class B 125 (12.5 to), with *Lock & Lift System*

System 100



Illustration shows Art. no. 67 110B

Outer diameter Ø (mm) Art. no.

With square support rim

Ø 110 67 110B

With round support rim

Ø 110 67 111B



Illustration shows Art. no. 67 111B

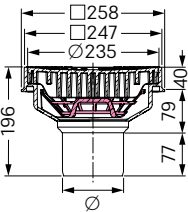


Illustration shows Art. no. 67 110B

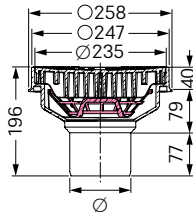


Illustration shows Art. no. 67 111B

Drainage capacity in l/s at an accumulation height 5 - 45 mm

Outer diameter Ø (mm)	5	10	20	25	35	45	Requirement according to EN 1253
Ø 110 vertical	0.95	1.90	4.50	5.60	9.40	9.50	≥ 1.40

Yard drain *Alrondo*

vertical outlet

Made of polymer. Vertical outlet, with
integrated odour trap.
Drainage capacity 1.6 l/sec flow rate
Cover plate 200×200 mm

Cover:

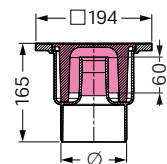
Round slotted cover Ø 140 mm,
screwed, can be driven over by
vehicles of up to 1 ton

System 100



Outer diameter Ø (mm) Art. no.

Ø 110 37 287 S



Yard drain *Ecoguss* 200

Lateral or vertical outlet

Upper section made of *Ecoguss Heavy Duty*,

drain body made of polymer

With sludge trap.

Drainage capacity 4.5 l/sec flow rate

Upper section made of *Ecoguss Heavy Duty*,

with square support rim

Cover:

Round slotted cover, class B 125 (12.5 to),

with *Lock & Lift* System



Illustration shows Art. no. 67 923B

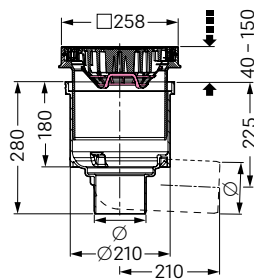


Illustration shows
Art. no. 67 922B, 67 923B

System 200



Outer diameter Ø (mm)	Art. no.
Lateral outlet	
Ø 110	67 923B
Vertical outlet	
Ø 110	67 922B

Yard drain System 200

Lateral or vertical outlet

Made of polymer. With lip seal and protective cover for use during construction.

Drainage capacity 4.5 l/sec flow rate

drain body made of polymer,

upper section with support rim

Cover:

Slotted cover, class A 15



Illustration shows Art. no. 67 020.30

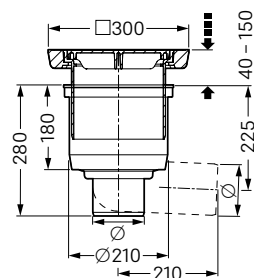


Illustration shows
Art. no. 67 020.30, 67 060.30

System 200



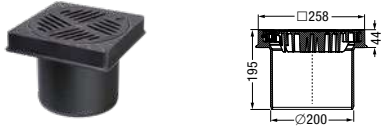
Outer diameter Ø (mm)	Art. no.
Lateral outlet	
Ø 110	67 020.30
Vertical outlet	
Ø 110	67 060.30

Modular system 200

System 200

Yard drains

Upper section



in Ecoguss Heavy Duty

Version contains: Upper section with support rim 250 × 250 mm, height adjustable

Cover: Round slotted cover Ø 235 mm in Ecoguss Heavy Duty, class B 125, Lock & Lift System, height adjustable from 40 – 150 mm

Art. no. 67 985



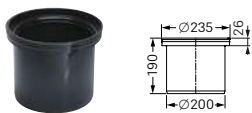
in polymer

Version contains: Upper section with support rim 250 × 250 mm, height adjustable

Cover: Round slotted cover Ø 218 mm, class A 15 / L 15

Art. no. 67 986

Accessories



Extension section

Material: Polymer

Installation height: 150 mm

without lateral inlet **Art. no. 67 400**



Extension section

Material: Polymer

Installation height: 240 mm

without lateral inlet **Art. no. 67 500**

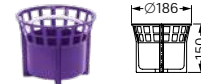


Extension section

Material: Polymer

Installation height: 240 mm

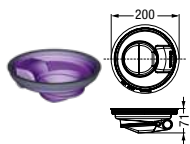
with lateral inlet **Art. no. 67 600**



Sludge basket

Material: PE-HD

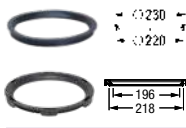
Art. no. 67 300



Multistop 200

Odour, foam, rodent and insect stop, for Art. no. 67 985, 67 923B, 67 922B

Art. no. 48 520

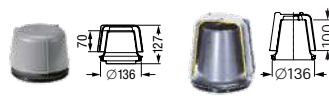


Lip seal

Art. no. 27 140

Non-slip mounting

Art. no. 27 141

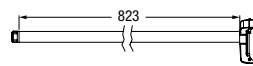


Bell-shaped odour trap insert

Material: PP, removable
sealing water height:

H 70 mm **Art. no. 27 170**

H 100 mm **Art. no. 27 171**



Lifting mechanism

For removing odour trap in case of deeper installation.

Compatibility: Art. no. 27 171, 67 960, 67 970

Art. no. 850 144



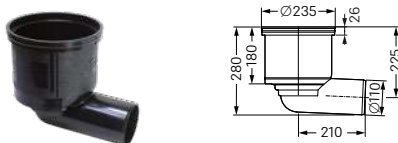
Locking and removal key

For Ecoguss drain covers with Lock & Lift System

Art. no. 67 007

Drain body in polymer

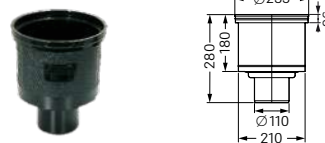
without odour trap



Lateral outlet 2.5°

Drainage capacity: 4.5 l/sec flow rate

Ø 110 **Art. no. 67 000**



Vertical outlet

Drainage capacity: 4.5 l/sec flow rate

Ø 110 **Art. no. 67 040**

Yard drain System 400

for higher load classes

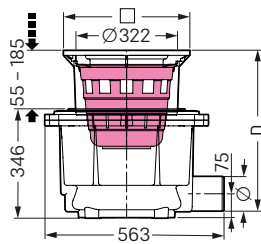
System 400



Made in polyethylene. Lateral outlet 2.5°, with sludge trap. Water-tight, resistant to aggressive wastewater. With fuel-resistant gaskets. Drainage capacity 4.5 l/sec flow rate. Installation depth (D) from 380 – 510 mm. Installation area 585 × 535 mm. Upper section with slotted cover, class A (1.5 to.) made of polymer, 400 × 400 mm, class B (12.5 to.) in cast iron according to EN 124, 400 × 400 mm and class D (40 to.) in cast iron according to EN 124, 450 × 450 mm for continuous height and level adjustment.



Outer diameter Ø (mm)	Art. no.
Ø 110	851 100A
Ø 110	851 100B
Ø 110	851 100D
Ø 160	851 150A
Ø 160	851 150B
Ø 160	851 150D



Yard drain System 400

for higher load classes

System 400



Made in polyethylene. Lateral outlet 2.5°, with odour trap and sludge trap. Water-tight, resistant to aggressive wastewater. With fuel-resistant gaskets. Drainage capacity 4.5 l/sec flow rate.

Installation depth (D) from

580 – 710 mm and

730 – 1080 mm

Installation area 585 × 535 mm

Upper section with slotted cover,

class A (1.5 to.) made of polymer, 400 × 400 mm,

class B (12.5 to.) in cast iron according to EN 124,

400 × 400 mm and class D (40 to.) in cast iron

according to EN 124, 450 × 450 mm for continuous height and level adjustment.



Installation depth 580 – 710 mm

Outer diameter Ø (mm)	Art. no.
Ø 110	851 101A
Ø 110	851 101B
Ø 110	851 101D
Ø 160	851 151A
Ø 160	851 151B
Ø 160	851 151D

Installation depth 730 – 1080 mm

Outer diameter Ø (mm)	Art. no.
Ø 110	851 102A
Ø 110	851 102B
Ø 110	851 102D
Ø 160	851 152A
Ø 160	851 152B
Ø 160	851 152D

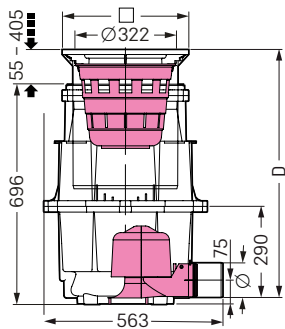


Illustration shows Art. no. 851 102A

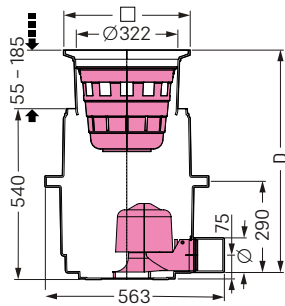


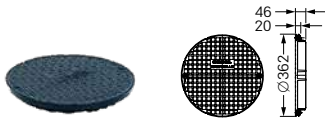
Illustration shows Art. no. 851 101A

Modular system 400

System 400

Yard drains

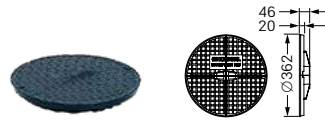
Covers



Cover plate in polymer

Class: A (1.5 to.)

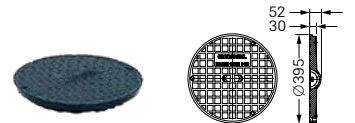
Art. no. 850 132



Cover plate in cast iron

Class: B (12.5 to.)

Art. no. 850 131



Cover plate in cast iron

Class: D (40 to.)

Compatibility: Art. no. 850 121

Art. no. 850 136

Upper section

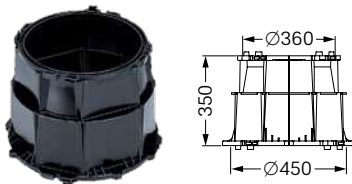


Class A, B

Continuously height adjustable, with clamping ring

Art. no. 850 120

Accessories



Extension section

Material: Polyethylene

Art. no. 850 101

Connecting wedges

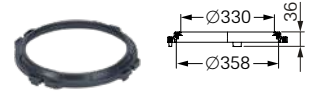
4 pieces

Art. no. 850 111



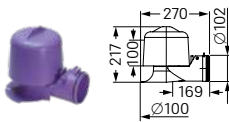
Transition section 450

Art. no. 850 102



Transition section 360

Art. no. 850 103

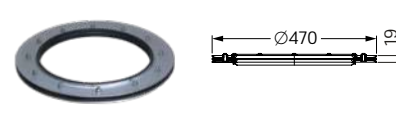
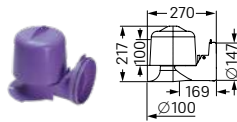


Odour traps

*Compatibility: Art. no. 850 009, 850 010

Ø 110 mm Art. no. 850 141

Ø 160 mm* Art. no. 850 142



Pressure sealing flange

Compatibility: Upper section

Art. no. 83 021

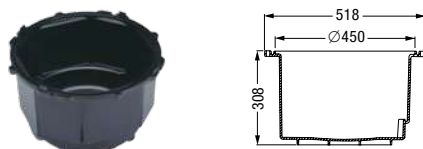


Elastomer waterproof membrane

Material: NK/SBR

Art. no. 83 022

Closed base in polyethylene



without outlet

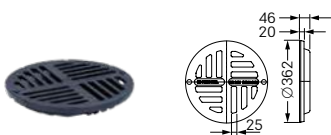
Art. no. 850 008

System 400



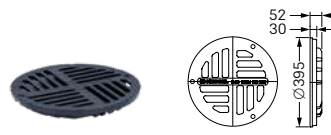
Slotted cover in polymer

Class: A (1.5 to.)
Art. no. 850 134



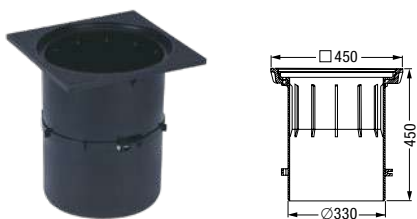
Slotted cover in cast iron

Class: B (12.5 to.)
Art. no. 850 135



Slotted cover in cast iron

Class: D (40 to.)
Compatibility: Art. no. 850 121
Art. no. 850 137



Class D

Continuously height adjustable, with clamping ring
Art. no. 850 121



Sludge trap

Material: Polymer
Art. no. 850 115



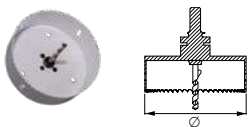
Profiled gasket 450

Art. no. 850 113



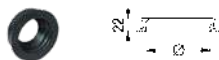
Profiled gasket 360

Art. no. 850 112



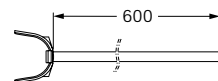
Hole saw

for drilling lateral surfaces for inlets and outlets \varnothing 50, 75, 110, 125 and 160
(Saw blade holder \varnothing = 190 mm)
Art. no. 50 100



Gaskets for pipe conduits

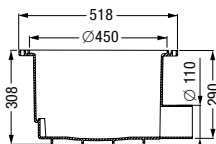
\varnothing 50 mm Art. no. 850 114
 \varnothing 75 mm Art. no. 850 116
 \varnothing 110 mm Art. no. 850 117
 \varnothing 125 mm Art. no. 850 118
 \varnothing 160 mm Art. no. 850 119



Lifting mechanism

For removing odour trap
Art. no. 850 143

Closed base in polyethylene



with outlet

\varnothing 110 mm Art. no. 850 009
 \varnothing 160 mm Art. no. 850 010

Gutter drains

The practical side of gutters.

Our practical gutter drains made of polymer are connected directly to the downpipe of the gutter and pass the rainwater through underground wastewater pipes and into the sewer, the stormwater collection tank or soakaways.



1 Gutter drain 2 Drain cover 3 Drainage pipe

Removable sludge bucket

Our gutter drains are equipped with a sludge bucket as protection against blockages caused by solids such as leaves or branches. The trap basket can be easily accessed through the removable drain cover and is therefore easy to clean.

Odour trap

We also supply gutter drains with removable bell-shaped odour trap for frost-free depths from 545 mm to protect against unpleasant odours from the sewer.

Variable connection options

Optional extension sections can be used to attach additional lateral inlets to the gutter drains.

Gutter drain

Lateral or vertical outlet

Made in polymer. Rain inlet cover with protective pipe made of polymer.
 With removable bell-shaped odour trap, two extension sections, sludge trap.
 With wall securing bracket.
 Drainage capacity 2.8 l/sec flow rate,
Note: For frost-free depth 545 mm

System 200

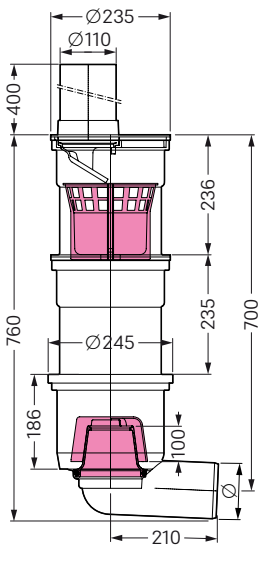


Illustration shows Art. no. 67 970

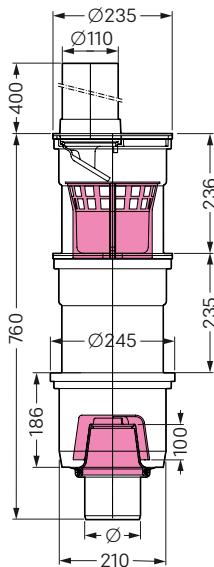


Illustration shows Art. no. 67 960



Illustration shows Art. no. 67 970

Outer diameter Ø (mm)	Art. no.
Lateral outlet	
Ø 110	67 970
Vertical outlet	
Ø 110	67 960

Gutter drain

Lateral or vertical outlet

Made in polymer. Rain inlet cover with protective pipe in synthetic material.
 With sludge trap.
 With/without wall securing device.
 Drainage capacity 4.5 l/sec flow rate

System 200

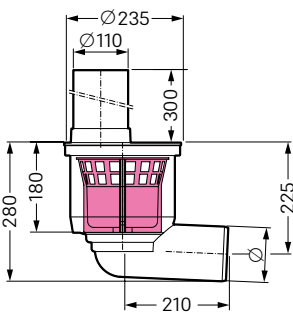


Illustration shows Art. no. 67 945

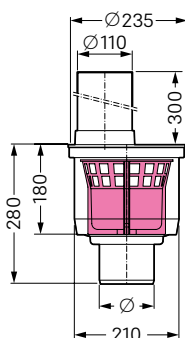


Illustration shows Art. no. 67 940



Illustration shows Art. no. 67 945

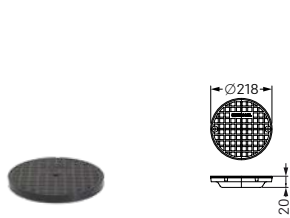
Lateral outlet	
Outer diameter Ø (mm)	Art. no.
With wall securing device	
Ø 110	67 945
Vertical outlet	
Outer diameter Ø (mm)	Art. no.
With wall securing device	
Ø 110	67 940
Without wall securing device	
Ø 110	67 997

Modular system 200

System 200

Gutter drains

Upper section



in polymer

Cover: Cover plate Ø 218 mm class A 15 / L 15 (1.5 to.), surface water tight

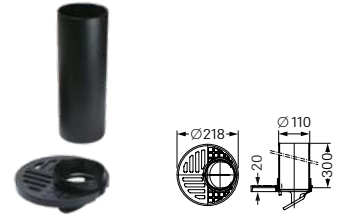
Art. no. 67 775



in polymer

Cover: Rain inlet cover Ø 218 mm with protective pipe Ø 110

Ø 110 Art. no. 67 750



in polymer

Cover: Rain inlet slotted cover Ø 218 mm, for additional surface drainage with protective pipe Ø 110

Ø 110 Art. no. 67 700

Accessories



Extension section

Material: Polymer

Installation height: 150 mm without lateral inlet Art. no. 67 400



Extension section

Material: Polymer

Installation height: 240 mm without lateral inlet Art. no. 67 500



Extension section

Material: Polymer

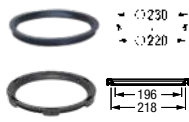
Installation height: 240 mm with lateral inlet Art. no. 67 600



Sludge basket

Material: PE-HD

Art. no. 67 300

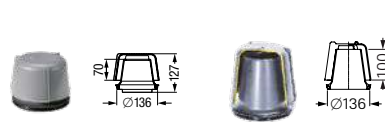


Lip seal

Art. no. 27 140

Non-slip mounting

Art. no. 27 141



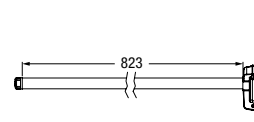
Bell-shaped odour trap insert

Material: PP, removable

sealing water height:

H 70 mm Art. no. 27 170

H 100 mm Art. no. 27 171

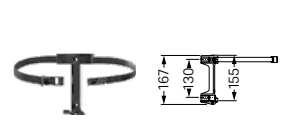


Lifting mechanism

For removing odour trap in case of deeper installation.

Compatibility: Art. no. 27 171, 67 960, 67 970

Art. no. 850 144

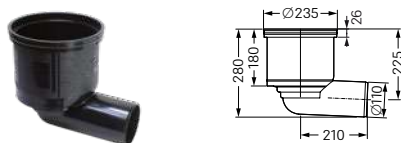


Wall securing bracket

Art. no. 67 800

Drain body in polymer

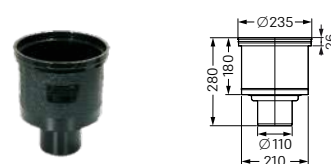
without odour trap



Lateral outlet 2.5°

Drainage capacity: 4.5 l/sec flow rate

Ø 110 Art. no. 67 000



Vertical outlet

Drainage capacity: 4.5 l/sec flow rate

Ø 110 Art. no. 67 040

Roof drains for flat roof surfaces

The well thought-through solution for the roof.

Our offer includes different roof drains for flat roof surfaces for safe and reliable drainage of roofs in all sizes. The drains are available with optional single or double seal and can be converted into a DIN-conforming emergency drain by fitting a retainer ring available as an accessory. We supply roof drains for flat roof surfaces not only made of polymer but also made of *Ecoguss resistant*, our high-tech composite, which combines the specific advantages of polymer and metal. They are available with outlets in nominal sizes from Ø 78 to Ø 125 mm.



Reliability - all year long, thanks to heating function

To ensure problem-free drainage of roofs even at low temperatures, our roof drains for flat roof surfaces are available with optional integrated heating. The heating function is integrated in a non-combustible insulated body and therefore does not pose a fire risk.

Drainage capacity in L/s at accumulation height 5 - 65 mm

Nominal size	5	15	25	35	45	55	65	Requirement to EN 1253
DN/OD 70/78 vertical	0,60	2,85	5,35	7,80	10,50	13,90	16,50	≥ 1,7
DN/OD 100/110 vertical	0,60	1,90	4,50	7,30	11,10	14,65	19,35	≥ 4,5
DN/OD 125/125 vertical	0,90	3,30	5,95	9,00	12,75	15,10	19,40	≥ 7,0

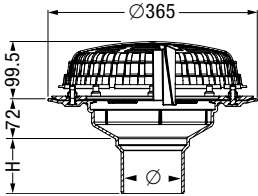
Resistance, convenience, cleanliness – all these are offered by *Ecoguss* – our high-tech composite.

➤ *Ecoguss* floor drain: page 232

Flat-roof drains *Ecoguss* with pressure sealing flange in *Ecoguss resistant*

System 200

Vertical outlet, with single seal, pressure sealing flange in *Ecoguss resistant*, gravel trap. Installation area: Ø 227 mm

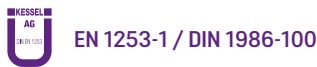


Outer diameter Ø (mm)	H in mm	Art. no.
Without heating		
Ø 78	96.5	48 370*
Ø 110	93	48 310*
Ø 125	93	48 312*
With heating		
Ø 78	96.5	48 370.03
Ø 110	93	48 310.03
Ø 125	93	48 312.03

* TÜV test mark only applies to marked items

Drainage capacity in l/s with 5 - 65 mm threshold

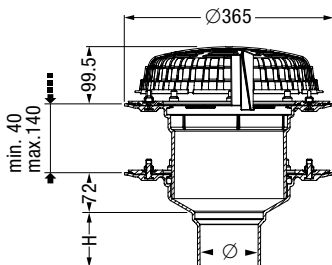
Outer diameter	5	15	25	35	45	55	65	According to DIN EN 1253
DN/DA 70/78 senkrecht	0,60	2,85	5,35	7,80	10,50	13,90	16,50	≥ 1,7
DN/DA 100/110 senkrecht	0,60	1,90	4,50	7,30	11,10	14,65	19,35	≥ 4,5
DN/DA 125/125 senkrecht	0,90	3,30	5,95	9,00	12,75	15,10	19,40	≥ 7,0



Flat-roof drains *Ecoguss* with pressure sealing flange in *Ecoguss resistant*

System 200

Vertical outlet, with double seal for installation in waterproof concrete, pressure sealing flange in *Ecoguss resistant* and counter flange, upper section in *Ecoguss resistant* Ø 200, gravel trap. Installation area: Ø 227 mm



Outer diameter Ø (mm)	H in mm	Art. no.
Without heating		
Ø 78	96.5	48 370.01*
Ø 110	93	48 310.01*
Ø 125	93	48 312.01*
With heating		
Ø 78	96.5	48 370.02
Ø 110	93	48 310.02
Ø 125	93	48 312.02

* TÜV test mark only applies to marked items

Drainage capacity in l/s with 5 - 65 mm threshold

Outer diameter	5	15	25	35	45	55	65	According to DIN EN 1253
DN/DA 70/78 senkrecht	0,60	2,85	5,35	7,80	10,50	13,90	16,50	≥ 1,7
DN/DA 100/110 senkrecht	0,60	1,90	4,50	7,30	11,10	14,65	19,35	≥ 4,5
DN/DA 125/125 senkrecht	0,90	3,30	5,95	9,00	12,75	15,10	19,40	≥ 7,0



Upgrade example: Single waterproofing

Ø 78, 110 or 125

➤ Flat-roof drain *Ecoguss*:
Product see page 319



Before: Flat-roof drain *Ecoguss*



Conversion

- ➊ Unlock **gravel trap** and remove
- ➋ Remove **counter flange**
- ➌ Insert **damming ring** as accessory
 - Ø 78, H = 35 mm (Art. no. 48 335)
 - Ø 110, H = 35 mm (Art. no. 48 335) or
 - Ø 125, H = 45 mm (Art. no. 48 345)



After: Flat-roof drain *Ecoguss*
with emergency overflow

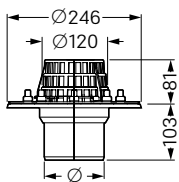
Flat-roof drain

with pressure sealing flange

Made in PP. Vertical outlet, with pressure sealing flange with counter flange in stainless steel AISI 304, with leaf trap.
 Drainage capacity 4.5 l/sec flow rate.
 Installation area: 180×180 mm



Outer diameter Ø (mm)	Art. no.
Ø 110	45 950



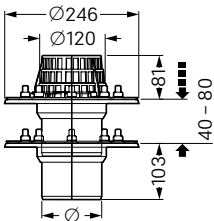
Flat-roof drain

with twin pressure sealing flanges

Made in PP. Vertical outlet, with twin sealing flanges, with pressure sealing flange with counter flange in stainless steel AISI 304, with leaf trap.
 Drainage capacity 4.5 l/sec flow rate.
 Installation area: 180×180 mm




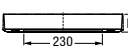
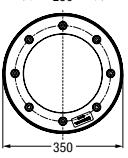



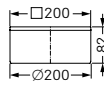



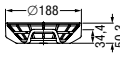

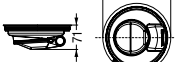
Outer diameter Ø (mm)	Art. no.
Ø 110	45 970



Accessories

System 200

Flat-roof drains *Ecoguss*

Damming ring		Outer diameter \varnothing (mm)	H in mm	Art. no.		
Damming ring	Compatibility: For drainage safety; for flat-roof drains <i>Ecoguss</i> Material: Polymer			\varnothing 75	35	48 335
				\varnothing 110	35	48 335
				\varnothing 125	45	48 345
Spacer ring				Art. no.		
Spacer ring	Compatibility: To adapt gravel trap to height of gravel; for flat-roof drains <i>Ecoguss</i> Material: <i>Ecoguss</i> resistant				48 302	
Upper section				Art. no.		
Upper section	Compatibility: For flat-roof drains <i>Ecoguss</i> Cover: Slotted cover and rim in stainless steel AISI 304, screwed, class K 3				48 954	
Hygiene and odour stop				Art. no.		
Temporary protective cover	Compatibility: For flat-roof drains <i>Ecoguss</i> Material: PP Function: With drainage function				45 301	
Leaf trap	Compatibility: For flat-roof drains <i>Ecoguss</i> Material: PP				48 300	
Multistop 200	Compatibility: Only in combination with <i>Ecoguss</i> roof drains with twin sealing system Function: Odour, foam, rodent and insect stop				48 520	

Accessories

System 200

Flat-roof drains *Ecoguss*

Insulating

Art. no.

without heating

Compatibility: For flat-roof drains *Ecoguss*
Material: Flame proof
Class: A 1

48 352

with heating

Compatibility: For flat-roof drains *Ecoguss*
Material: Flame proof
Class: A 1

48 353

Extension section Ø 200

Compatibility: For flat-roof drains *Ecoguss*
Material: Flame proof
Class: A 1

48 354



Reinforcement plate

Art. no.

Reinforcement plate

Compatibility: For flat-roof drains *Ecoguss*
Material: Galvanized steel
Plate size: 600 × 600 mm
Cut-out: 270 mm
Material thickness: 1.5 mm

48 351

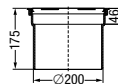
Extension section

Art. no.

Extension section

Compatibility: For flat-roof drains *Ecoguss*
Inclusive: Lip seal
Height: 175 mm

48 988



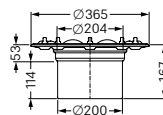
Extension section in *Ecoguss resistant*

Art. no.

with pressure sealing flange and counter flange

Compatibility: For flat-roof drains *Ecoguss*
Additional function: For installation in waterproof concrete
Height: 166 mm

48 958



5. Separators

Fully certified treatment of contaminated
wastewater

Overview

Separator technology

5.1 Grease separators



Grease separator
EasyClean free

Auto Mix & Pump
➤ Page 336, 348



Mix & Pump
➤ Page 338, 349



Auto Mix
➤ Page 340, 350



Mix
➤ Page 342, 351



Direct
➤ Page 344, 352



Standard
➤ Page 346, 353



Grease separator
EasyClean free Basic

Direct
➤ Page 356



Standard
➤ Page 357



Grease separator
EasyClean free Self Disposal

➤ Page 366



Grease separator
EasyClean ground

Auto Mix & Pump
➤ Page 372



Auto Mix
➤ Page 373



Direct
➤ Page 374



Standard
➤ Page 376



Multi Direct, Multi Standard
➤ Page 381



Grease separator
EasyClean Modular

Direct
➤ Page 359






Standard
➤ Page 359








Grease separator
EasyClean free UnderSink

➤ Page 369

Installation location

-  Outdoor, underground
-  Indoor, free-standing
-  Floor slab installation

Disposal options

-  Auto Mix & Pump
-  Mix & Pump
-  Auto Mix
-  Mix
-  Direct
-  Standard/Basic

5.2 Coalescence / Oil / Fuel separators 5.3 Sediment separators



Secondary wastewater treatment
Bifena

➤ Page 387



Coalescence and oil separator
EasyOil free & ground

➤ Page 391, 393



Sediment separators
EasySink free & ground

➤ Page 402

5.4 Starch separators



Starch separator
EasyStarch free & ground

➤ Page 407



5.1 Grease separators

Removal of fats, oils and grease
from kitchen wastewater





Everything specialists need to know

Why you need a grease separator



Areas of application

- Kitchen operations and large-scale catering establishments, e.g. restaurants, hotels, canteens, motorway service stations
- Butchers
- Slaughterhouses / Abattoirs
- Soap and stearin factories
- Cooking oil refineries
- Canning factories
- ... and many more

Statutory provision

Grease separators are required by law for fat, oil and grease contaminated wastewater streams from commercial kitchens.

Pipe blockages, corrosion and odour formation

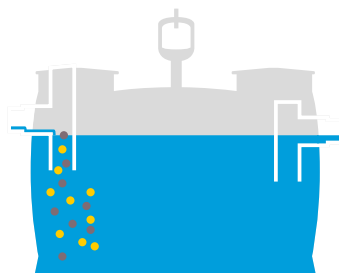
Fat, oil, grease and food residue entering the building's wastewater drainage pipe system results in build-up, blockage and odour issues which are difficult to handle. This results in corrosion or complete failure of the drainage pipe system.

Environmental protection

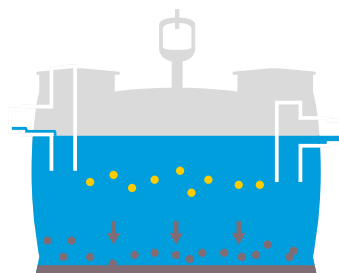
Grease separators prevent the environment from being contaminated by greasy wastewater and contribute to the trouble-free operation of sewage treatment plants.

Operation of a grease separator

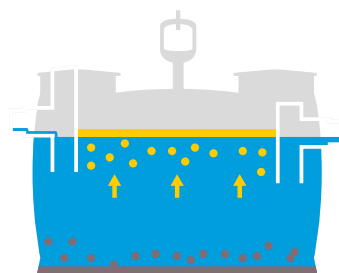
The operation of grease separators is based on the gravity principle. Lighter than water oil and grease float to the surface of the separator, heavier than water flood sludge settle to the bottom of the separator and the clean treated water leaves the separator via a protected outlet.



The contaminated wastewater is routed into the grease separator where it is slowed down by a deflector plate.



Substances that are heavier than water sink to the bottom and settle in the sludge trap.



Grease and oil rise to the top and form a grease layer that is retained between the inlet and outlet.

Polymer grease separators

Polymer grease separator systems are an advantageous alternative to stainless steel solutions as they 100 % corrosion free.

The polyethylene material used is resistant to aggressive fatty acids – and therefore particularly durable. In addition to the statutory provision, we provide a 20-year warranty with regard to the leak tightness and structural safety of tanks and upper sections.



Grease separator disposal - the right choice

Grease separators must be completely emptied on a regular basis to dispose of the retained waste materials. The options range from a basic system with manual disposal to a fully automatic disposal system.

Direct disposal

Enables the extraction of the grease separator contents through a permanently installed disposal pipe without opening the tank.

Shredder-Mix-System

Fully mixes the contents of the grease separator into a slurry to aide in the disposal process.

Control unit

Enables the convenient setting and control of the grease separator functions using a control unit mounted on the wall.

Disposal pump

Handles the disposal of the grease separator in the case of longer distances between the separator and the disposal truck.

Fully automatic

Controls the disposal and rinsing processes fully automatically.

Disposal options	EasyClean free (Basic)		EasyClean free			
	Standard	Direct	Mix	Auto Mix	Mix & Pump	Auto Mix & Pump
Connection for direct disposal		✓	✓	✓	✓	✓
Shredder-Mix-System			✓	✓	✓	✓
Control unit				✓	✓	✓
Disposal pump					✓	✓
Fully automatic						✓

Connection to the drainage system

with a lifting station or a hybrid lifting station.

Separator outlet below sewer level – lifting station required



- 1 Properly sized lifting station
- 2 Two 45° curved fittings
- 3 Wastewater calming section
- 4 Connected drainage fixtures

Separator outlet above sewer level- hybrid lifting station required



- 1 Properly sized hybrid lifting station
- 2 Two 45° curved fittings
- 3 Wastewater calming section
- 4 Connected drainage fixtures

The wastewater must flow into the grease separator system with gravity. Grease separator systems whose water level is below the backwater level (see EN 752-1) or sewer level should be connected to a properly sized lifting station (shown as 1 in the illustration).

The wastewater pipes to the separator systems must have a gradient of at least 2 % (1:50) to prevent grease blockage. If this is not possible for constructional or operational reasons, and/or if longer pipes are necessary, suitable measures must be taken to prevent grease blockages and deposits. The transition from downpipes to horizontal pipes must be handled with two 45° curved fittings with a large radius.

A wastewater calming section, the length of which corresponds to at least the 10-fold of the inlet pipe's nominal width in millimetres, must then be provided immediately before the inlet of the separator.

Discharge points, such as floor drains, must be equipped with odour traps and, if necessary, with sludge buckets that can be removed for cleaning.

Grease separators *EasyClean free*

The versatile solution for free-standing installation

The KESSEL grease separator *EasyClean free* combines ease of installation, cleaning performance and energy efficiency. The narrow tank shape offers two advantages: 1) the complete technology can be integrated on the base area of the separator. 2) easier to transport the grease separator through narrow entranceways and set it up directly against the wall, saving a great deal of space.



Improved access thanks to the curved shape

Also ideal for retrofitting and renovation work in rooms with very narrow access.

Remote control

located at the disposal truck connection.



Control unit

with multilingual (EN, DE, FR, IT, PL, NL) digital display for operating state and servicing instructions as well as connection option for building management system.



Improved cleaning results

Integrated sloped base for extraction at the lowest point (only 3 litres residual sludge volume).

For nominal sizes NS 2 - NS 10.



Grease separators 60 Hz/400 V

Now also available in 60 Hz. For more information contact us at info@kessel.com

Refill unit

Hot water for cleaning and cold water for refilling the separator after disposal.

SonicControl

for the measurement, display and control of the grease layer thickness in a grease separator.



Resistant to aggressive grease

The polyethylene material used is 100% resistant to aggressive grease. This guarantees a long service life since there is no damage to the material due to corrosion.



Planning made easy!

Direction of flow can be changed on site by swapping inlet and outlet.

Shredder-Mix-System

serves to mix and clean the tank contents without odor emission during disposal. 13-steps fully automated disposal (adjustable steps to meet site requirements)

Warranty

KESSEL offers a factory extended warranty of 20 years on the polyethylene grease separator tanks.



Grease separator *EasyClean* free Auto Mix & Pump NS 2 – 10 for free-standing installation



EN 1825

Tank

Manufactured from virgin, non-recycled polyethylene, for free standing installation in frost protected areas, with integrated sludge trap, sloped interior base improves cleaning and reduces disposal time, inlet flow calming system and outlet flow regulation device, inlet and outlet interchangeable, slanted twin access covers with quick release odour tight snap closures, inspection window with interior cleaning arm, 75 mm OD PN 10 pressure disposal pipe, with integrated fork lift grips at base of separator, low weight - compact design, 100 % corrosion free polyethylene body construction (20 year warranty).

Disposal System

Auto Mix & Pump version fully automated odour free disposal, cleaning and refilling system at touch of button, maintenance free macerating pump (stainless steel blades) for separator cleaning and disposal, includes closure valve for easy pump removal, pump floor mount included with installation hardware and anti-vibration matt, actuator valve for automated transfer from cleaning to disposal mode, pumping capacity 3.0 kW (stronger pumps available on request), 5 m cable length, top mounted water jet(s) for grease layer breakup and water spray nozzles for interior wall cleaning during disposal, twin 1 inch solenoid valves for connection of cold and hot water pipes to separator, 1 inch interior threaded refill inlet with air gap.

Control Unit with LCD display control settable in English, German, French, Italian, Dutch or Polish language and mains power safety on / off switch, with BMS connections (potential free contact and Modbus).

Delivery: System completely assembled.

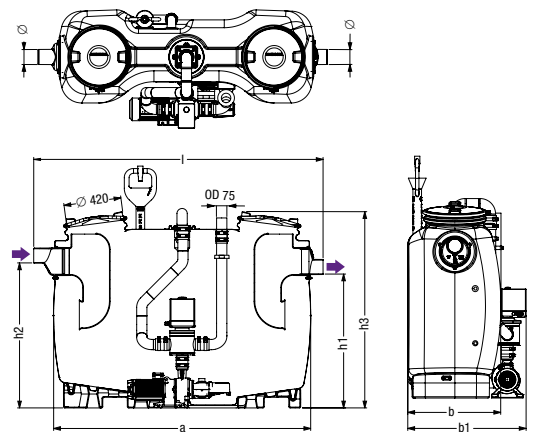
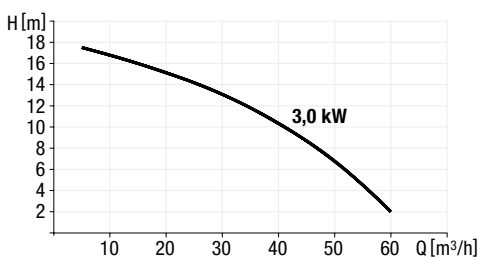
- **Accessories:** Sampling chamber, remote control, *TeleControl* pages 361 – 363, lifting stations see chapter "3"
- **Technical note:** page 360
- **Note:** Also available in 60 Hz / 400 V



without SonicControl *with SonicControl*

NS	Art. no.	Art. no.
NS 2	93 002.01/PVS	93 002.02/PVS
NS 3	93 003.01/PVS	93 003.02/PVS
NS 4	93 004.01/PVS	93 004.02/PVS
NS 7	93 007.01/PVS	93 007.02/PVS
NS 10	93 010.01/PVS	93 010.02/PVS

Pumping capacity



NS	Ø (mm)	a (mm)	Installation dimension			h1 (mm)	h2 (mm)	h3 (mm)	Weight (kg)	Sludge trap (l)	Water and grease (l)	Grease storage (l)	Total (l)
			l × b (mm)	b1 (mm)	b (mm)								
2	110	1500	1735 × 680	860	985	1055	1435	160	200	400	100	600	
3	110	1500	1735 × 680	860	985	1055	1435	165	300	300	120	600	
4	110	1880	2115 × 680	860	985	1055	1435	178	400	400	160	800	
7	160	1910	2145 × 940	1130	1185	1255	1655	226	700	650	280	1350	
10	160	2590	2820 × 940	1130	1185	1255	1655	272	1000	900	400	1900	



Ø = Outer diameter b1 = Set-up dimensions

Grease separator *EasyClean* free Auto Mix & Pump NS 15 – 50

for free-standing installation



EN 1825

Tank

Manufactured from virgin, non-recycled polyethylene, for free-standing installation in frost-protected areas, with integrated sludge trap and sloped base for fast and clean disposal, with two domed covers made of polymer, with quick-release closures, sealed odour-tight, with suction device installed for the joint disposal of contents of sludge trap and grease separator chamber, intake pipe 75 mm OD PN 10 in accordance with DIN 2501, Storz-B coupling R 2 1/2 for connection to the disposal vehicle. Inspection window with wiper. Inlet and outlet Ø 200 / 250 mm for the connection to PE-HD pipes according to DIN 19537, HT pipes according to DIN 19560, PP or AS.



Disposal System

Auto Mix & Pump with program-controlled disposal and rinsing device and Shredder-Mix-System, KESSEL disposal system Auto Mix & Pump with switching distribution and actuator valve, mixing and rinsing device via jet and conic nozzles, external pump(s) 3.0 kW (IP55, 400 V, 50 Hz; stronger pumps available on request) with integrated chopping mechanism and closure valve, 5 m cable length, 2 solenoid valves 1", with refill inlet in accordance with DIN 1988.

Control Unit for actuating the pump(s) with potential-free contact and Modbus.

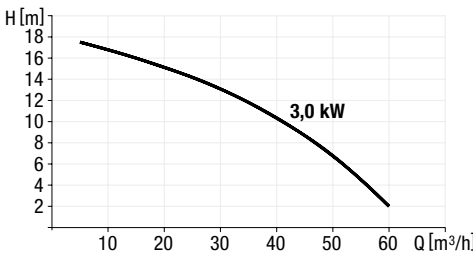
Delivery: System completely assembled.

➤ **Accessories:** Sampling chamber, remote control, *TeleControl*, *SonicControl* level sensing system pages 361 – 363, lifting stations see chapter "3"

➤ **Technical note:** page 360

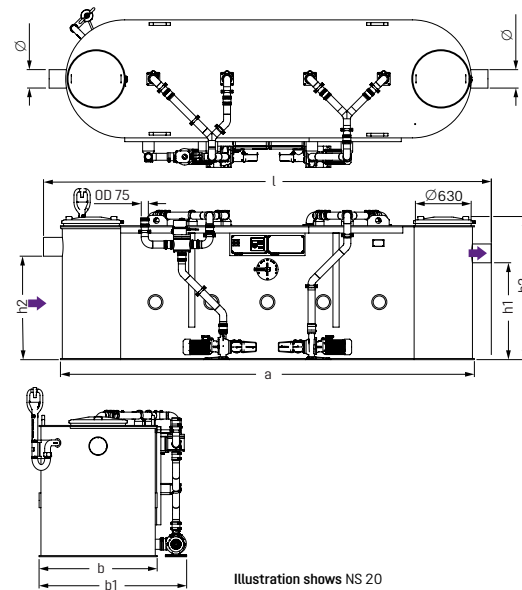
➤ **Note:** Also available in 60 Hz / 400 V

Pumping capacity



without *SonicControl*

NS	Art. no.
NS 15	93 015-06-PVS
NS 20	93 020-06-PVS
NS 25	93 025-06-PVS
NS 30	93 030-06-PVS
NS 35	93 035.01/PVS
NS 40	93 040.01/PVS
NS 50	93 050.01/PVS



NS	Ø (mm)	a (mm)	Installation dimension l × b (mm)	b1 (mm)	h1 (mm)	h2 (mm)	h3 (mm)	Sludge trap (l)	Water and grease (l)	Grease storage (l)	Total (l)
15	200	3400	3755 × 1280	1600	1130	1200	1625	1500	2020	600	3520
20	200	4400	4760 × 1280	1600	1030	1100	1625	2000	2230	800	4230
25	200	4780	5140 × 1280	1600	1030	1100	1625	2500	2050	1000	4550
30	250	4700	5160 × 1280	1600	1170	1240	1625	3000	2250	1200	5250
35	250	6000	6480 × 1500	1770	1130	1200	1662	3500	4500	1400	8000
40	250	6200	6680 × 1600	1870	1130	1200	1662	4000	5000	1600	9000
50	250	6200	6680 × 1800	2070	1350	1420	1882	5000	6200	2240	11200



Ø = Outer diameter b1 = Set-up dimensions

Grease separator *EasyClean* free Mix & Pump NS 2 – 10

for free-standing installation



EN 1825

Tank

Manufactured from virgin, non-recycled polyethylene, for free standing installation in frost protected areas, with integrated sludge trap, sloped in base improves cleaning and reduces disposal time, inlet flow calming syst and outlet flow regulation device, inlet and outlet interchangeable, slanted twin access covers with quick release odour tight snap closures, inspectic window with interior cleaning arm, 75 mm OD PN 10 pressure disposal pipe with integrated fork lift grips at base of separator, low weight - compact de 100 % corrosion free polyethylene body construction (20 year warranty).

Disposal System

Mix & Pump version manually controlled odour free disposal, cleaning and refilling system at touch of button, maintenance free macerating pump (stainless steel blades) for separator cleaning and disposal, includes closure valve for easy pump removal, pump floor mount included with installation hardware and anti-vibration matt, manual hand valve for transfer from cleaning to disposal mode, pumping capacity 3.0 kW (stronger pumps available on request), 5 m cable length, top mounted water jet(s) for grease layer breakup and water spray nozzles for interior wall cleaning during disposal, 1 inch manual hand valve for water refill, 1 inch interior threaded refill inlet with air gap.

Control Unit with LCD display control settable in English, German, French, Italian, Dutch or Polish language and mains power safety on/off switch, with BMS connections.

Delivery: System completely assembled.

➤ **Accessories:** Sampling chamber pages 361 – 363, lifting stations see chapter "3"

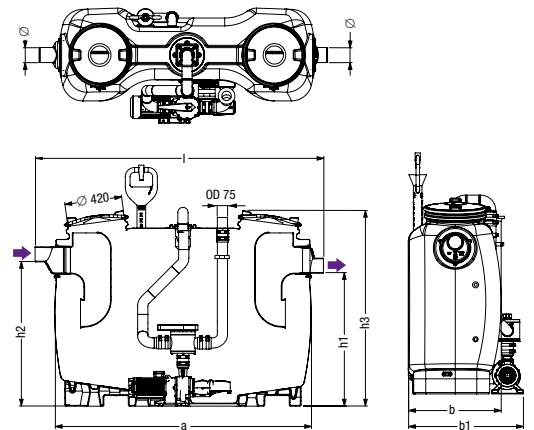
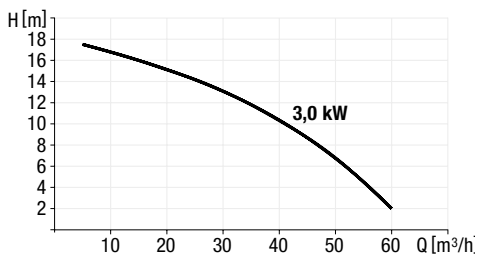
➤ **Technical note:** page 360

➤ **Note:** Also available in 60 Hz / 400 V



	without <i>SonicControl</i>	with <i>SonicControl</i>
NS	Art. no.	Art. no.
NS 2	93 002.01/MS	93 002.02/MS
NS 3	93 003.01/MS	93 003.02/MS
NS 4	93 004.01/MS	93 004.02/MS
NS 7	93 007.01/MS	93 007.02/MS
NS 10	93 010.01/MS	93 010.02/MS

Pumping capacity



NS	Ø (mm)	a (mm)	Installation dimension l × b (mm)	b1 (mm)	h1 (mm)	h2 (mm)	h3 (mm)	Weight (kg)	Sludge trap (l)	Water and grease (l)	Grease storage (l)	Total (l)
2	110	1500	1735 × 680	860	985	1055	1435	155	200	400	100	600
3	110	1500	1735 × 680	860	985	1055	1435	160	300	300	120	600
4	110	1880	2115 × 680	860	985	1055	1435	173	400	400	160	800
7	160	1910	2145 × 940	1130	1185	1255	1655	221	700	650	280	1350
10	160	2590	2820 × 940	1130	1185	1255	1655	267	1000	900	400	1900

Ø = Outer diameter b1 = Set-up dimensions



Grease separator *EasyClean* free Mix & Pump NS 15 – 50

for free-standing installation



EN 1825

Tank

Manufactured from virgin, non-recycled polyethylene, for free-standing installation in frost-protected areas, with integrated sludge trap and sloped base for fast and clean disposal, with two domed covers made of polymer, with quick-release closures, sealed odour-tight, with suction device installed for the joint disposal of contents of sludge trap and grease separator chamber, intake pipe 75 mm OD PN 10 in accordance with DIN 2501, Storz-B coupling R 2 1/2 for connection to the disposal vehicle. Inspection window with wiper. Inlet and outlet \varnothing 200 / 250 mm for the connection to PE-HD pipes according to DIN 19537, HT pipes according to DIN 19560, PP or AS.

Disposal System

Mix & Pump with manual disposal and rinsing device and Shredder-Mix-System, KESSEL disposal system Mix & Pump with switching distribution, mixing and rinsing device via jet and conic nozzles, external pump(s), with integrated chopping mechanism and closure valve, pumping capacity 3.0 kW (stronger pumps available on request), 5 m cable length, refill inlet in accordance with DIN 1988.

Control Unit for actuating the pump(s).

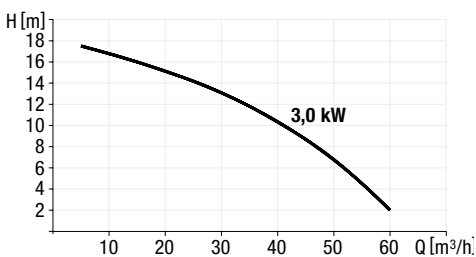
Delivery: System completely assembled.

➤ **Accessories:** Sampling chamber, *SonicControl* level sensing system pages 361 – 363, lifting stations see chapter "3"

➤ **Technical note:** page 360

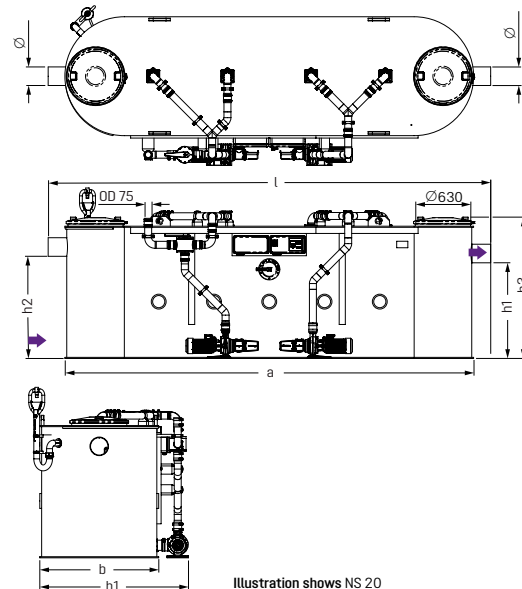
➤ **Note:** Also available in 60 Hz / 400 V

Pumping capacity



without *SonicControl*

NS	Art. no.
NS 15	93 015-06-MS
NS 20	93 020-06-MS
NS 25	93 025-06-MS
NS 30	93 030-06-MS
NS 35	93 035.01/MS
NS 40	93 040.01/MS
NS 50	93 050.01/MS



NS	\varnothing (mm)	a (mm)	Installation dimension l × b (mm)	b1 (mm)	h1 (mm)	h2 (mm)	h3 (mm)	Sludge trap (l)	Water and grease (l)	Grease storage (l)	Total (l)
15	200	3400	3755 × 1280	1600	1130	1200	1625	1500	2020	600	3520
20	200	4400	4760 × 1280	1600	1030	1100	1625	2000	2230	800	4230
25	200	4780	5140 × 1280	1600	1030	1100	1625	2500	2050	1000	4550
30	250	4700	5160 × 1280	1600	1170	1240	1625	3000	2250	1200	5250
35	250	6000	6480 × 1500	1770	1130	1200	1662	3500	4500	1400	8000
40	250	6200	6680 × 1600	1870	1130	1200	1662	4000	5000	1600	9000
50	250	6200	6680 × 1800	2070	1350	1420	1882	5000	6200	2240	11200

\varnothing = Outer diameter b1 = Set-up dimensions



Grease separators *EasyClean* free Auto Mix NS 2 – 10

for free-standing installation



EN 1825

Tank

Manufactured from virgin, non-recycled polyethylene, for free-standing installation in frost protected areas, with integrated sludge trap, sloped interior base improves cleaning and reduces disposal time, inlet flow calming system and outlet flow regulation device, inlet and outlet interchangeable, slanted twin access covers with quick release odour tight snap closures, inspection window with interior cleaning arm, 75 mm OD PN 10 pressure disposal pipe, with integrated fork lift grips at base of separator, low weight - compact design, 100% corrosion free polyethylene body construction (20 year warranty).

Disposal System

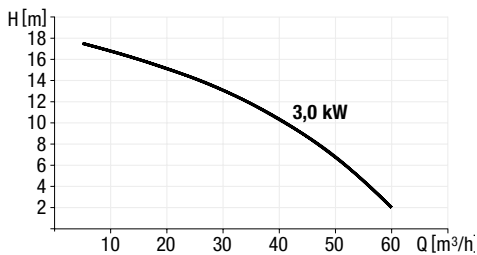
Auto Mix version with simultaneous mixing and cleaning of separator interior - requires disposal truck with vacuum system for separator disposal, disposal is completely odour free, maintenance free macerating pump (stainless steel blades) includes closure valve for easy pump removal, pump floor mount included with installation hardware and anti-vibration matt, top mounted water jet(s) for grease layer breakup and water spray nozzles for interior wall cleaning during disposal, 1 inch interior thread refill inlet with air gap, pumping capacity 3.0 kW (stronger pumps available on request), 5 m cable length, twin 1 inch solenoid valves for connection of cold and hot water pipes to separator, with remote control offering full separator disposal control from remote location (from disposal truck location).

Control Unit with LCD display control settable in English, German or French language and mains power safety on/off switch, with BMS connections.

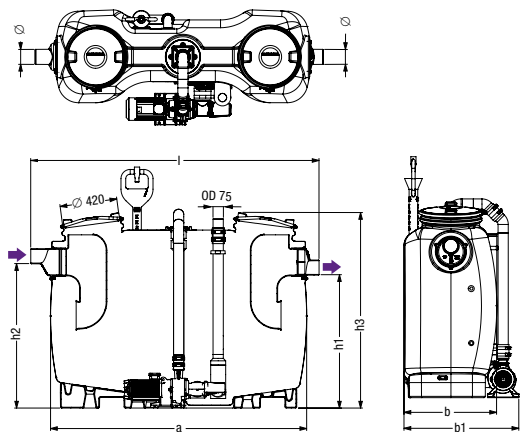
Delivery: System completely assembled.

- **Accessories:** Sampling chamber, remote control, *TeleControl* pages 361 – 363, lifting stations see chapter "3"
- **Technical note:** page 360
- **Note:** Also available in 60 Hz / 400 V

Pumping capacity



	without <i>SonicControl</i>	with <i>SonicControl</i>
NS	Art. no.	Art. no.
NS 2	93 002.01/DSP	93 002.02/DSP
NS 3	93 003.01/DSP	93 003.02/DSP
NS 4	93 004.01/DSP	93 004.02/DSP
NS 7	93 007.01/DSP	93 007.02/DSP
NS 10	93 010.01/DSP	93 010.02/DSP



NS	Ø (mm)	a (mm)	Installation dimension				h1 (mm)	h2 (mm)	h3 (mm)	Weight (kg)	Sludge trap (l)	Water and grease (l)		Total (l)
			l × b (mm)	b1 (mm)	Water	Grease storage								
2	110	1500	1735 × 680	860	985	1055	1435	150	200	400	100	600		
3	110	1500	1735 × 680	860	985	1055	1435	155	300	300	120	600		
4	110	1880	2115 × 680	860	985	1055	1435	168	400	400	160	800		
7	160	1910	2145 × 940	1130	1185	1255	1655	216	700	650	280	1350		
10	160	2590	2820 × 940	1130	1185	1255	1655	262	1000	900	400	1900		



Ø = Outer diameter b1 = Set-up dimensions

Grease separator *EasyClean* free Auto Mix NS 15 – 50

for free-standing installation



EN 1825

Tank

Manufactured from virgin, non-recycled polyethylene, for free-standing installation in frost-protected areas, with integrated sludge trap and sloped base for fast and clean disposal, with two domed covers made of polymer, with quick-release closures, sealed odour-tight, with suction device installed for the joint disposal of contents of sludge trap and grease separator chamber, intake pipe 75 mm OD PN 10 in accordance with DIN 2501, Storz-B coupling R 2 1/2 for connection to the disposal vehicle. 2 solenoid valves 1", inspection window with wiper, viewing window with wiper. Inlet and outlet \varnothing 200 / 250 mm for the connection to PE-HD pipes according to DIN 19537, HT pipes according to DIN 19560, PP or AS.

Disposal System

Auto Mix with direct disposal and Shredder-Mix-System, KESSEL Shredder-Mix-System with mixing and rinsing via jet and conic nozzles, external pump(s), with integrated chop-ping mechanism and closure valve, pumping capacity 3.0 kW (stronger pumps available on request), 5 m cable length, refill inlet in accordance with DIN 1988, R 1 connection.

Control Unit for actuating the pump(s) and the solenoid valves.

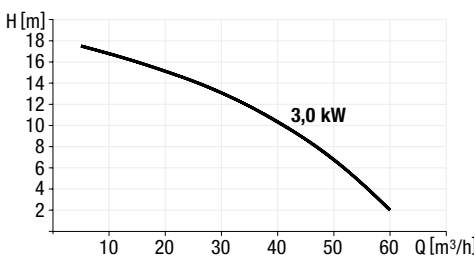
Delivery: System completely assembled.

➤ **Accessories:** Sampling chamber, remote control, *TeleControl*, *SonicControl* level sensing system pages 361 – 363, lifting stations see chapter "3"

➤ **Technical note:** page 360

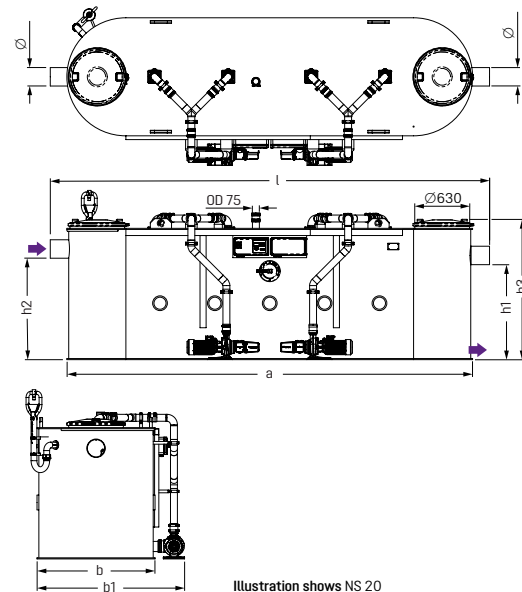
➤ **Note:** Also available in 60 Hz / 400 V

Pumping capacity



without *SonicControl*

NS	Art. no.
NS 15	93 015-06-DSP
NS 20	93 020-06-DSP
NS 25	93 025-06-DSP
NS 30	93 030-06-DSP
NS 35	93 035.01/DSP
NS 40	93 040.01/DSP
NS 50	93 050.01/DSP



NS	\varnothing (mm)	a (mm)	Installation dimension l × b (mm)	b1 (mm)	h1 (mm)	h2 (mm)	h3 (mm)	Sludge trap (l)	Water and grease (l)	Grease storage (l)	Total (l)
15	200	3400	3755 × 1280	1600	1130	1200	1625	1500	2020	600	3520
20	200	4400	4760 × 1280	1600	1030	1100	1625	2000	2230	800	4230
25	200	4780	5140 × 1280	1600	1030	1100	1625	2500	2050	1000	4550
30	250	4700	5160 × 1280	1600	1170	1240	1625	3000	2250	1200	5250
35	250	6000	6480 × 1500	1770	1130	1200	1662	3500	4500	1400	8000
40	250	6200	6680 × 1600	1870	1130	1200	1662	4000	5000	1600	9000
50	250	6200	6680 × 1800	2070	1350	1420	1882	5000	6200	2240	11200

\varnothing = Outer diameter b1 = Set-up dimensions



Grease separators *EasyClean* free Mix NS 2 - 10 for free-standing installation



EN 1825

Tank

Manufactured from virgin, non-recycled polyethylene, for free standing installation in frost protected areas, with integrated sludge trap, sloped interior base improves cleaning and reduces disposal time, inlet flow calming system and outlet flow regulation device, inlet and outlet interchangeable, slanted twin access covers with quick release odour tight snap closures, inspection window with interior cleaning arm, 75 mm OD PN 10 pressure disposal pipe, with integrated fork lift grips at base of separator, low weight - compact design, 100 % corrosion free polyethylene body construction (20 year warranty).

Disposal System

Mix version with simultaneous mixing and cleaning of separator interior - requires disposal truck with vacuum system for separator disposal, disposal is completely odour free, maintenance free macerating pump (stainless steel blades) includes closure valve for easy pump removal, pump floor mount included with installation hardware and anti-vibration matt, pumping capacity 3.0 kW (stronger pumps available on request), 5 m cable length, top mounted water jet(s) for grease layer breakup and water spray nozzles for interior wall cleaning during disposal, 1 inch interior thread refill inlet with air gap, 1 inch manual hand valve for water refill, with hand held operation controller.

Delivery: System completely assembled.

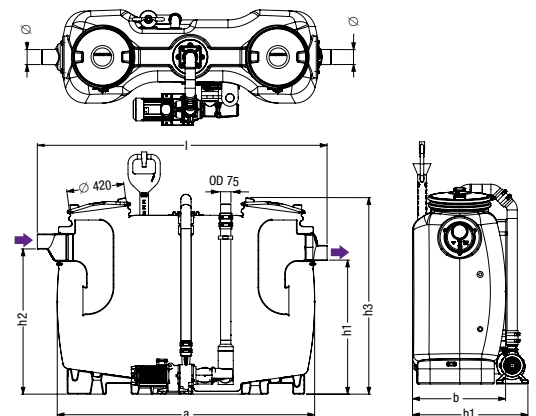
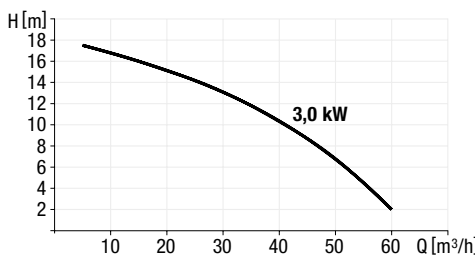
- **Accessories:** Sampling chamber, inspection window pages 361 - 363, lifting stations see chapter "3"
- **Technical note:** page 360
- **Note:** Also available in 60 Hz / 400 V



without SonicControl *with SonicControl*

NS	Art. no.	Art. no.
<i>Without inspection window</i>		
NS 2	93 002.01/DS	93 002.02/DS
NS 3	93 003.01/DS	93 003.02/DS
NS 4	93 004.01/DS	93 004.02/DS
NS 7	93 007.01/DS	93 007.02/DS
NS 10	93 010.01/DS	93 010.02/DS
<i>With inspection window</i>		
NS 2	93 002.31/DS	93 002.32/DS
NS 3	93 003.31/DS	93 003.32/DS
NS 4	93 004.31/DS	93 004.32/DS
NS 7	93 007.31/DS	93 007.32/DS
NS 10	93 010.31/DS	93 010.32/DS

Pumping capacity



NS	Ø (mm)	a (mm)	Installation dimension			h1 (mm)	h2 (mm)	h3 (mm)	Weight (kg)	Sludge trap (l)	Water and Grease (l)		Total (l)
			l × b (mm)	b1 (mm)	Water and grease (l)						Grease storage (l)		
2	110	1500	1735 × 680	860	985	1055	1435	145	200	400	100	600	
3	110	1500	1735 × 680	860	985	1055	1435	150	300	300	120	600	
4	110	1880	2115 × 680	860	985	1055	1435	163	400	400	160	800	
7	160	1910	2145 × 940	1130	1185	1255	1655	211	700	650	280	1350	
10	160	2590	2820 × 940	1130	1185	1255	1655	257	1000	900	400	1900	



Ø = Outer diameter b1 = Set-up dimensions

Grease separator *EasyClean* free Mix NS 15 – 50

for free-standing installation



EN 1825

Tank

Manufactured from virgin, non-recycled polyethylene, for free-standing installation in frost-protected areas, with integrated sludge trap and sloped base for fast and clean disposal, with two domed covers made of polymer, with quick-release closures, sealed odour-tight, with suction device installed for the joint disposal of contents of sludge trap and grease separator chamber, intake pipe 75 mm OD PN 10 in accordance with DIN 2501, Storz-B coupling R 2 1/2 for connection to the disposal vehicle. Inlet and outlet \varnothing 200 / 250 mm for the connection to PE-HD pipes according to DIN 19537, HT pipes according to DIN 19560, PP or AS.



Disposal System

Mix with direct disposal and Shredder-Mix-System, KESSEL Shredder-Mix-System with mixing and rinsing via jet and conic nozzles, external pump(s), with integrated chopping mechanism and closure valve, pumping capacity 3.0 kW (stronger pumps available on request), 5 m cable length, refill inlet in accordance with DIN 1988, R 1 connection.

Switch Unit for actuating the pump.

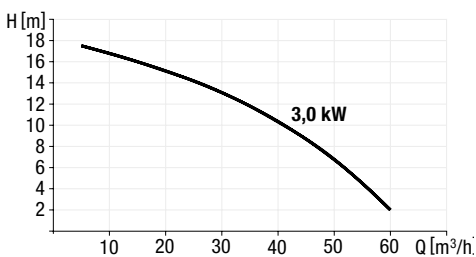
Delivery: System completely assembled.

➤ **Accessories:** Sampling chamber, inspection window, *SonicControl* level sensing system pages 361 – 363; lifting stations see chapter "3"

➤ **Technical note:** page 360

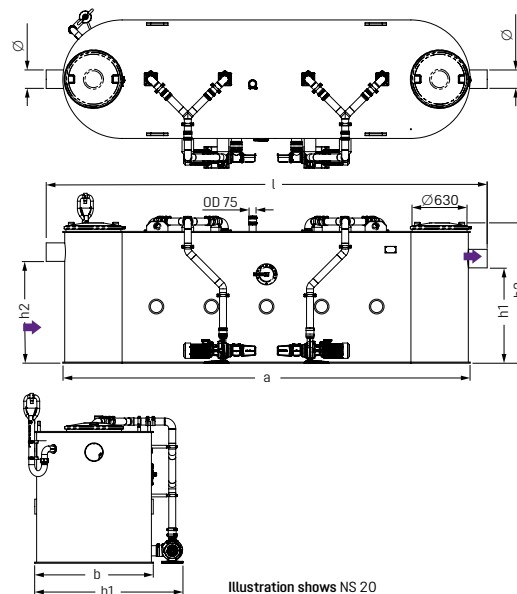
➤ **Note:** Also available in 60 Hz / 400 V

Pumping capacity



without *SonicControl*

NS	Art. no.
NS 15	93 015-06-DS
NS 20	93 020-06-DS
NS 25	93 025-06-DS
NS 30	93 030-06-DS
NS 35	93 035.01/DS
NS 40	93 040.01/DS
NS 50	93 050.01/DS



NS	\varnothing (mm)	a (mm)	Installation dimension l × b (mm)	b1 (mm)	h1 (mm)	h2 (mm)	h3 (mm)	Sludge trap (l)	Water and grease (l)	Grease storage (l)	Total (l)
15	200	3400	3755 × 1280	1600	1130	1200	1625	1500	2020	600	3520
20	200	4400	4760 × 1280	1600	1030	1100	1625	2000	2230	800	4230
25	200	4780	5140 × 1280	1600	1030	1100	1625	2500	2050	1000	4550
30	250	4700	5160 × 1280	1600	1170	1240	1625	3000	2250	1200	5250
35	250	6000	6480 × 1500	1770	1130	1200	1662	3500	4500	1400	8000
40	250	6200	6680 × 1600	1870	1130	1200	1662	4000	5000	1600	9000
50	250	6200	6680 × 1800	2070	1350	1420	1882	5000	6200	2240	11200

\varnothing = Outer diameter b1 = Set-up dimensions



Grease separators *EasyClean* free Direct NS 2 – 10 for free-standing installation



EN 1825

Tank

Manufactured from virgin, non-recycled polyethylene, for free standing installation in frost protected areas, with integrated sludge trap, sloped interior base improves cleaning and reduces disposal time, inlet flow calming system and outlet flow regulation device, inlet and outlet interchangeable, slanted twin access covers with quick release odour tight snap closures, 75 mm OD PN 10 pressure disposal pipe, with integrated fork lift grips at base of separator, low weight - compact design, 100% corrosion free polyethylene body construction (20 year warranty).

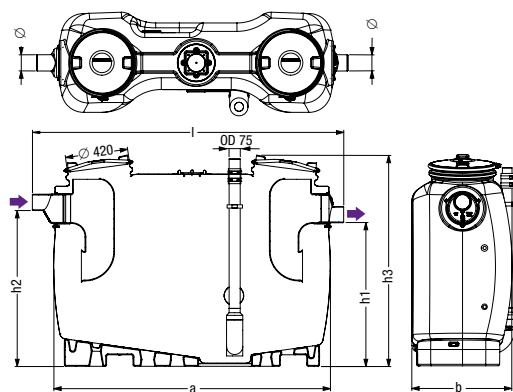
Disposal System

Direct version with factory installed pressure pipe suction outlet - requires disposal truck with vacuum system for separator disposal, disposal is completely odour free.

Delivery: System completely assembled.

➤ **Accessories:** Sampling chamber, inspection window, refill inlet; lifting stations see chapter "3", pages 361 – 363

➤ **Technical note:** page 360



without SonicControl *with SonicControl*

NS	Art. no.	Art. no.
Without accessories		
NS 2	93 002.01/D	93 002.02/D
NS 3	93 003.01/D	93 003.02/D
NS 4	93 004.01/D	93 004.02/D
NS 7	93 007.01/D	93 007.02/D
NS 10	93 010.01/D	93 010.02/D

With inspection window		
NS 2	93 002.21/D	93 002.22/D
NS 3	93 003.21/D	93 003.22/D
NS 4	93 004.21/D	93 004.22/D
NS 7	93 007.21/D	93 007.22/D
NS 10	93 010.21/D	93 010.22/D

With refill inlet		
NS 2	93 002.11/D	93 002.12/D
NS 3	93 003.11/D	93 003.12/D
NS 4	93 004.11/D	93 004.12/D
NS 7	93 007.11/D	93 007.12/D
NS 10	93 010.11/D	93 010.12/D

With inspection window and refill inlet		
NS 2	93 002.31/D	93 002.32/D
NS 3	93 003.31/D	93 003.32/D
NS 4	93 004.31/D	93 004.32/D
NS 7	93 007.31/D	93 007.32/D
NS 10	93 010.31/D	93 010.32/D

NS	Ø (mm)	a (mm)	Installation dimension			Weight (kg)	Sludge trap (l)	Water and grease (l)	Grease storage (l)	Total (l)	
			l × b (mm)	h1 (mm)	h2 (mm)						h3 (mm)
2	110	1500	1735 × 680	985	1055	1435	69	200	400	100	600
3	110	1500	1735 × 680	985	1055	1435	74	300	300	120	600
4	110	1880	2115 × 680	985	1055	1435	87	400	400	160	800
7	160	1910	2145 × 940	1185	1255	1655	135	700	650	280	1350
10	160	2590	2820 × 940	1185	1255	1655	181	1000	900	400	1900

Ø = Outer diameter b1 = Set-up dimensions



Grease separator *EasyClean* free Direct NS 15 – 50

for free-standing installation



EN 1825

Tank

Manufactured from virgin, non-recycled polyethylene, for free-standing installation in frost-protected areas, with integrated sludge trap and sloped base for fast and clean disposal, with two domed covers made of polymer, with quick-release closures, sealed odour-tight, with suction device installed for the joint disposal of contents of sludge trap and grease separator chamber, intake pipe 75 mm OD PN 10 in accordance with DIN 2501, Storz-B coupling R 2 1/2 for connection to the disposal vehicle.

Inlet and outlet \varnothing 200 / 250 mm for the connection to PE-HD pipes according to DIN 19537, HT pipes according to DIN 19560, PP or AS.

Disposal System

Direct version with factory installed pressure pipe suction outlet - requires disposal truck with vacuum system for separator disposal, disposal is completely odour free.

Delivery: System completely assembled.

➤ **Accessories:** Inspection window and refill inlet, sampling chamber; lifting stations see chapter "3", pages 361 – 363

➤ **Technical note:** page 360

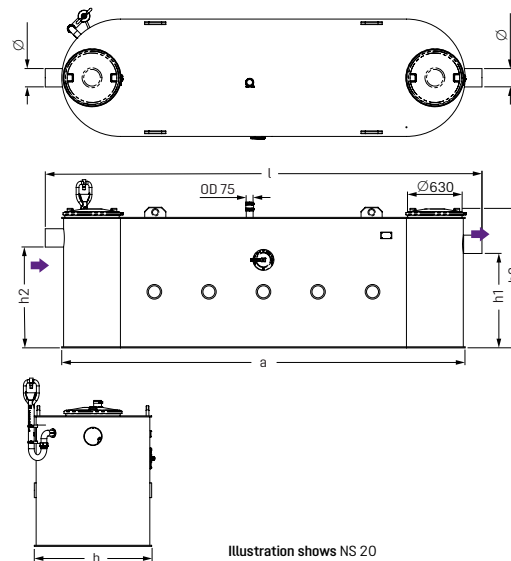


without *SonicControl*

NS Art. no.

Without accessories

NS 15	93 015-06-D
NS 20	93 020-06-D
NS 25	93 025-06-D
NS 30	93 030-06-D
NS 35	93 035.01/D
NS 40	93 040.01/D
NS 50	93 050.01/D



NS	\varnothing (mm)	a (mm)	Installation dimension l × b (mm)	h1 (mm)	h2 (mm)	h3 (mm)	Sludge trap (l)	Water and grease (l)	Grease storage (l)	Total (l)
15	200	3400	3755 × 1280	1130	1200	1625	1500	2020	600	3520
20	200	4400	4760 × 1280	1030	1100	1625	2000	2230	800	4230
25	200	4780	5140 × 1280	1030	1100	1625	2500	2050	1000	4550
30	250	4700	5160 × 1280	1170	1240	1625	3000	2250	1200	5250
35	250	6000	6480 × 1500	1130	1200	1662	3500	4500	1400	8000
40	250	6200	6680 × 1600	1130	1200	1662	4000	5000	1600	9000
50	250	6200	6680 × 1800	1350	1420	1882	5000	6200	2240	11200

\varnothing = Outer diameter



Grease separators *EasyClean* free Standard NS 2 – 10 for free-standing installation



EN 1825

Tank

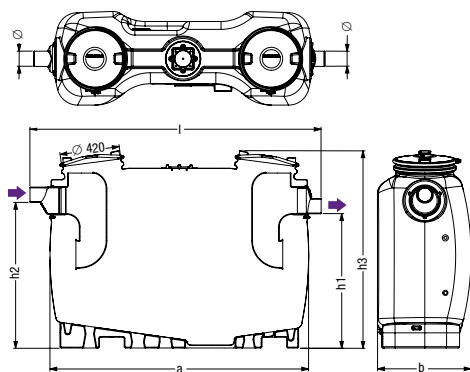
Manufactured from virgin, non-recycled polyethylene, for free standing installation in frost protected areas, with integrated sludge trap, sloped interior base improves cleaning and reduces disposal time, inlet flow calming system and outlet flow regulation device, inlet and outlet interchangeable, slanted twin access covers with quick release odour tight snap closures, integrated fork lift grips at base of separator, 100% corrosion free polyethylene body construction (20 year warranty).

Disposal System

Standard version requires disposal truck with vacuum system for separator disposal.

Delivery: System completely assembled.

- **Accessories:** Sampling chamber, inspection window, refill inlet; lifting stations see chapter "3", pages 361 – 363
- **Technical note:** page 360



without SonicControl with SonicControl

NS	Art. no.	Art. no.
Without accessories		
NS 2	93 002.01	93 002.02
NS 3	93 003.01	93 003.02
NS 4	93 004.01	93 004.02
NS 7	93 007.01	93 007.02
NS 10	93 010.01	93 010.02
With inspection window		
NS 2	93 002.21	93 002.22
NS 3	93 003.21	93 003.22
NS 4	93 004.21	93 004.22
NS 7	93 007.21	93 007.22
NS 10	93 010.21	93 010.22
With refill inlet		
NS 2	93 002.11	93 002.12
NS 3	93 003.11	93 003.12
NS 4	93 004.11	93 004.12
NS 7	93 007.11	93 007.12
NS 10	93 010.11	93 010.12
With inspection window and refill inlet		
NS 2	93 002.31	93 002.32
NS 3	93 003.31	93 003.32
NS 4	93 004.31	93 004.32
NS 7	93 007.31	93 007.32
NS 10	93 010.31	93 010.32

NS	Ø (mm)	a (mm)	Installation dimension l × b (mm)	h1 (mm)	h2 (mm)	h3 (mm)	Weight (kg)	Sludge trap (l)	Water and grease (l)	Grease storage (l)	Total (l)
2	110	1500	1735 × 680	985	1055	1435	69	200	400	100	600
3	110	1500	1735 × 680	985	1055	1435	74	300	300	120	600
4	110	1880	2115 × 680	985	1055	1435	87	400	400	160	800
7	160	1910	2145 × 940	1185	1255	1655	135	700	650	280	1350
10	160	2590	2820 × 940	1185	1255	1655	181	1000	900	400	1900

Ø = Outer diameter b1 = Set-up dimensions



Grease separator *EasyClean* free Standard NS 15 – 50

for free-standing installation



EN 1825

Tank

Manufactured from virgin, non-recycled polyethylene, for free-standing installation in frost-protected areas, with integrated sludge trap, two domed covers made of polymer, with quick-release closure, sealed odour-tight. Inlet and outlet \varnothing 200 / 250 mm for the connection to PE-HD pipes according to DIN 19537, HT pipes according to DIN 19560, PP or AS.

Disposal System

Standard version requires disposal truck with vacuum system for separator disposal.

Delivery: System completely assembled.

➤ **Accessories:** Inspection window and refill inlet, sampling chamber; lifting stations see chapter "3", pages 361 – 363

➤ **Technical note:** page 360



without *SonicControl*

NS	Art. no.
Without accessories	
NS 15	93 015-06
NS 20	93 020-06
NS 25	93 025-06
NS 30	93 030-06
NS 35	93 035.01
NS 40	93 040.01
NS 50	93 050.01

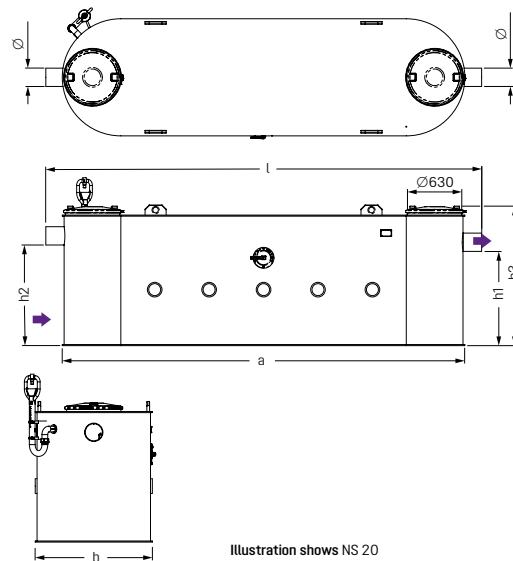


Illustration shows NS 20

NS	\varnothing (mm)	a (mm)	Installation dimension l × b (mm)	h1 (mm)	h2 (mm)	h3 (mm)	Sludge trap (l)	Water and grease (l)	Grease storage (l)	Total (l)
15	200	3400	3755 × 1280	1130	1200	1625	1500	2020	600	3520
20	200	4400	4760 × 1280	1030	1100	1625	2000	2230	800	4230
25	200	4780	5140 × 1280	1030	1100	1625	2500	2050	1000	4550
30	250	4700	5160 × 1280	1170	1240	1625	3000	2250	1200	5250
35	250	6000	6480 × 1500	1130	1200	1662	3500	4500	1400	8000
40	250	6200	6680 × 1600	1130	1200	1662	4000	5000	1600	9000
50	250	6200	6680 × 1800	1350	1420	1882	5000	6200	2240	11200

\varnothing = Outer diameter



Grease separator *EasyClean* round free Auto Mix & Pump NS 10 – 20 for free-standing installation



EN 1825

Tank

Manufactured from virgin, non-recycled polyethylene, for free-standing installation in frost-protected areas, with integrated sludge trap, with integrated sloped base directing wastewater into mixing / disposal pump, twin access covers with quick-release odour tight covers, with suction device installed for the joint disposal of contents of sludge trap and grease separator chamber, intake pipe 75 mm OD PN 10 in accordance with DIN 2501, Storz-B coupling R 2 1/2 for connection to the disposal vehicle. Inspection window with wiper. Inlet and outlet \varnothing 160 / 200 mm for the connection to PE-HD pipes according to DIN 19537, HT pipes according to DIN 19560, PP or AS.



Disposal System

Auto Mix & Pump with program-controlled disposal and rinsing device and Shredder-Mix-System, KESSEL disposal system Auto Mix & Pump with switching distribution and actuator valve, mixing and rinsing device via jet and conic nozzles, external pump(s) 3.0 kW (IP55, 400 V, 50 Hz; stronger pumps available on request) with integrated chopping mechanism and closure valve, 5 m cable length, 2 solenoid valves 1", with refill inlet in accordance with DIN 1988.

Control Unit for actuating the pump(s) with potential-free contact and Modbus.

Delivery: System completely assembled.

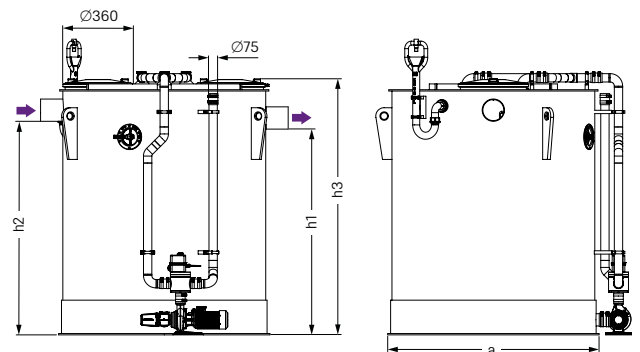
➤ **Accessories:** Sampling chamber, remote control, *TeleControl*, *SonicControl* level sensing system page 361 – 363, lifting stations see chapter "3"

➤ **Technical note:** page 360

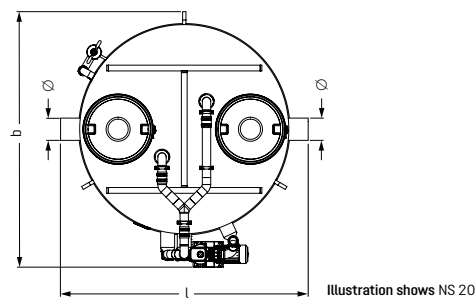
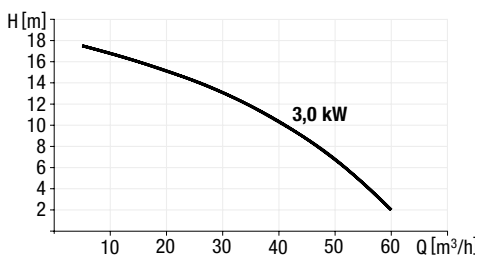
➤ **Note:** Also available in 60 Hz / 400 V

without *SonicControl*

NS	Art. no.
NS 10	93 010.05/PVS
NS 15	93 015.05/PVS
NS 20	93 020.05/PVS



Pumping capacity



NS	Ø (mm)	a (mm)	Installation dimension l × b (mm)	h1 (mm)	h2 (mm)	h3 (mm)	Sludge trap (l)	Water and grease (l)	Grease storage (l)	Total (l)
10	160	1570	1900 × 1915	1500	1570	1910	1000	1500	400	2500
15	200	1880	2230 × 2300	1550	1620	2020	1500	2300	600	3800
20	200	1880	2230 × 2300	1850	1920	2300	2000	2650	800	4650



Ø = Outer diameter

Grease separator *EasyClean* round free Mix & Pump NS 10– 20

for free-standing installation



EN 1825

Tank

Manufactured from virgin, non-recycled polyethylene, for free-standing installation in frost-protected areas, with integrated sludge trap, with integrated sloped base directing wastewater into mixing / disposal pump, twin access covers with quick-release odour tight covers, with suction device installed for the joint disposal of contents of sludge trap and grease separator chamber, intake pipe 75 mm OD PN 10 in accordance with DIN 2501, Storz-B coupling R 2 1/2 for connection to the disposal vehicle. Inspection window with wiper. Inlet and outlet Ø 160 / 200 mm for the connection to PE-HD pipes according to DIN 19537, HT pipes according to DIN 19560, PP or AS.



Disposal System

Mix & Pump with manual disposal and rinsing device and Shredder-Mix-System, KESSEL disposal system Mix & Pump with switching distribution, mixing and rinsing device via jet and conic nozzles, external pump(s), with integrated chopping mechanism and closure valve, pumping capacity 3.0 kW (stronger pumps available on request), 5 m cable length, refill inlet in accordance with DIN 1988.

Control Unit for actuating the pump(s).

Delivery: System completely assembled.

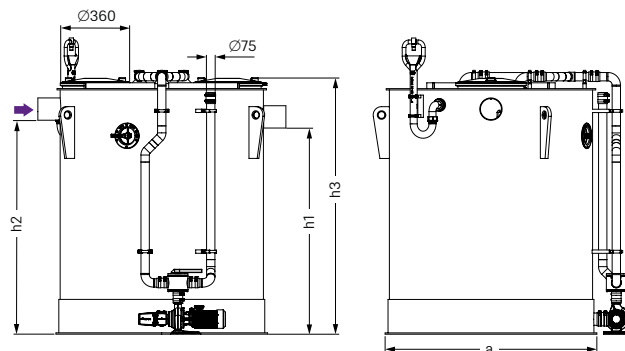
➤ **Accessories:** Sampling chamber, *SonicControl* level sensing system page 361 – 363, lifting stations see chapter "3"

➤ **Technical note:** page 360

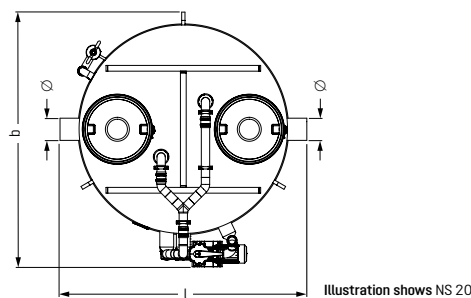
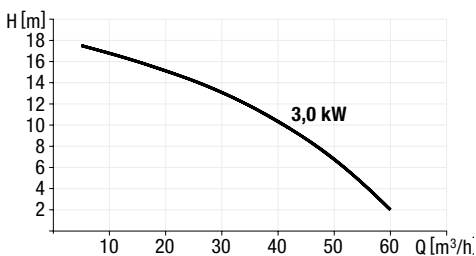
➤ **Note:** Also available in 60 Hz / 400 V

without *SonicControl*

NS	Art. no.
NS 10	93 010.05/MS
NS 15	93 015.05/MS
NS 20	93 020.05/MS



Pumping capacity



NS	Ø (mm)	a (mm)	Installation dimension l × b (mm)	h1 (mm)	h2 (mm)	h3 (mm)	Sludge trap (l)	Water and grease (l)	Grease storage (l)	Total (l)
10	160	1570	1900 × 1915	1500	1570	1910	1000	1500	400	2500
15	200	1880	2230 × 2300	1550	1620	2020	1500	2300	600	3800
20	200	1880	2230 × 2300	1850	1920	2300	2000	2650	800	4650

Ø = Outer diameter



Grease separator *EasyClean* round free Auto Mix NS 10 – 20 for free-standing installation



EN 1825

Tank

Manufactured from virgin, non-recycled polyethylene, for free-standing installation in frost-protected areas, with integrated sludge trap, with integrated sloped base directing wastewater into mixing / disposal pump, twin access covers with quick-release odour tight covers, with suction device installed for the joint disposal of contents of sludge trap and grease separator chamber, intake pipe 75 mm OD PN 10 in accordance with DIN 2501, Storz-B coupling R 2 1/2 for connection to the disposal vehicle.

2 solenoid valves 1", viewing window with wiper, inspection window with wiper. Inlet and outlet \varnothing 160 / 200 mm for the connection to PE-HD pipes according to DIN 19537, HT pipes according to DIN 19560, PP or AS.

Disposal System

Auto Mix with direct disposal and Shredder-Mix-System, KESSEL Shredder-Mix-System with mixing and rinsing via jet and conic nozzles, external pump(s), with integrated chopping mechanism and closure valve, pumping capacity 3.0 kW (stronger pumps available on request), 5 m cable length, refill inlet in accordance with DIN 1988, R 1 connection.

Control Unit for actuating the pump(s) and the solenoid valves.

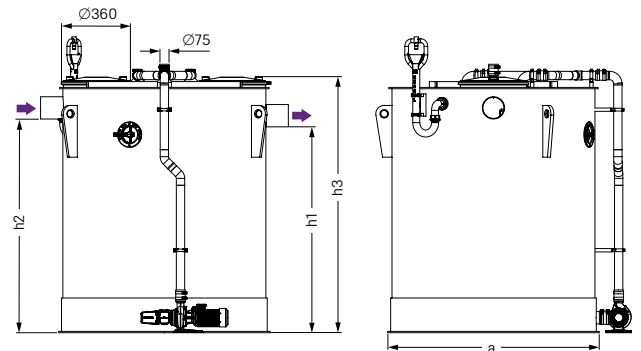
Delivery: System completely assembled.

- **Accessories:** Sampling chamber, remote control, *TeleControl*, *SonicControl* level sensing system page 361 – 363, lifting stations see chapter "3"
- **Technical note:** page 360
- **Note:** Also available in 60 Hz / 400 V



without *SonicControl*

NS	Art. no.
NS 10	93 010.05/DSP
NS 15	93 015.05/DSP
NS 20	93 020.05/DSP



Pumping capacity

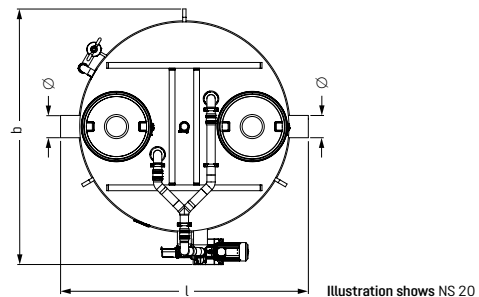
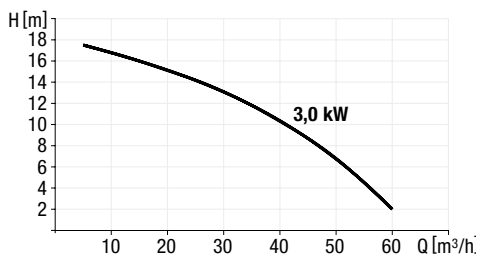


Illustration shows NS 20

NS	\varnothing (mm)	a (mm)	Installation dimension l × b (mm)	h1 (mm)	h2 (mm)	h3 (mm)	Sludge trap (l)	Water and grease (l)	Grease storage (l)	Total (l)
10	160	1570	1900 × 1915	1500	1570	1910	1000	1500	400	2500
15	200	1880	2230 × 2300	1550	1620	2020	1500	2300	600	3800
20	200	1880	2230 × 2300	1850	1920	2300	2000	2650	800	4650

\varnothing = Outer diameter



Grease separator *EasyClean* round free Mix NS 10 – 20

for free-standing installation



EN 1825

Tank

Manufactured from virgin, non-recycled polyethylene, for free-standing installation in frost-protected areas, with integrated sludge trap, with integrated sloped base directing wastewater into mixing / disposal pump, twin access covers with quick-release odour tight covers, with suction device installed for the joint disposal of contents of sludge trap and grease separator chamber, intake pipe 75 mm OD PN 10 in accordance with DIN 2501, Storz-B coupling R 2 1/2 for connection to the disposal vehicle. Inlet and outlet \varnothing 160 / 200 mm for the connection to PE-HD pipes according to DIN 19537, HT pipes according to DIN 19560, PP or AS.



Disposal System

Mix with direct disposal and Shredder-Mix-System, KESSEL Shredder-Mix-System with mixing and rinsing via jet and conic nozzles, external pump(s), with integrated chopping mechanism and closure valve, pumping capacity 3.0 kW (stronger pumps available on request), 5 m cable length, refill inlet in accordance with DIN 1988, R 1 connection.

Control Unit for actuating the pump.

Delivery: System completely assembled.

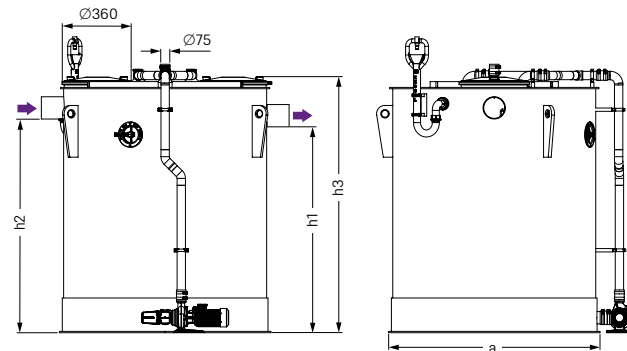
➤ **Accessories:** Sampling chamber, inspection window, *SonicControl* level sensing system page 361 – 363, lifting stations see chapter "3"

➤ **Technical note:** page 360

➤ **Note:** Also available in 60 Hz / 400 V

without *SonicControl*

NS	Art. no.
NS 10	93 010.05/DS
NS 15	93 015.05/DS
NS 20	93 020.05/DS



Pumping capacity

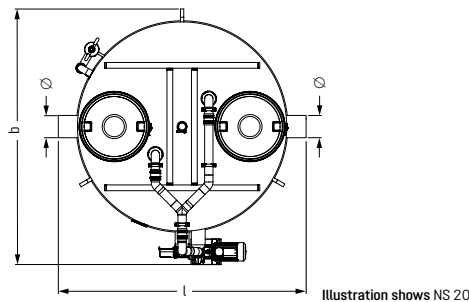
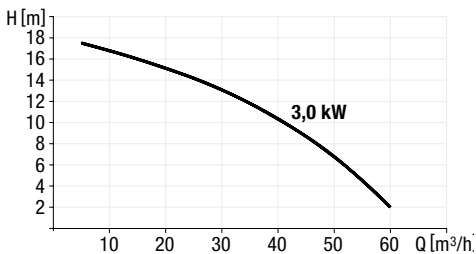


Illustration shows NS 20

NS	\varnothing (mm)	a (mm)	Installation dimension l × b (mm)	h1 (mm)	h2 (mm)	h3 (mm)	Sludge trap (l)	Water and grease (l)	Grease storage (l)	Total (l)
10	160	1570	1900 × 1915	1500	1570	1910	1000	1500	400	2500
15	200	1880	2230 × 2300	1550	1620	2020	1500	2300	600	3800
20	200	1880	2230 × 2300	1850	1920	2300	2000	2650	800	4650

\varnothing = Outer diameter



Grease separator *EasyClean* round free Direct NS 10 – 20

for free-standing installation



EN 1825

Tank

Manufactured from virgin, non-recycled polyethylene, for free-standing installation in frost-protected areas, with integrated sludge trap, with integrated sloped base directing wastewater into mixing / disposal pump, twin access covers with quick-release odour tight covers, with suction device installed for the joint disposal of contents of sludge trap and grease separator chamber, intake pipe 75 mm OD PN 10 in accordance with DIN 2501, Storz-B coupling R 2 1/2 for connection to the disposal vehicle. Inlet and outlet Ø 160 / 200 mm for the connection to PE-HD pipes according to DIN 19537, HT pipes according to DIN 19560, PP or AS.

Disposal System

Direct version with factory installed pressure pipe suction outlet - requires disposal truck with vacuum system for separator disposal, disposal is completely odour free.

Delivery: System completely assembled.

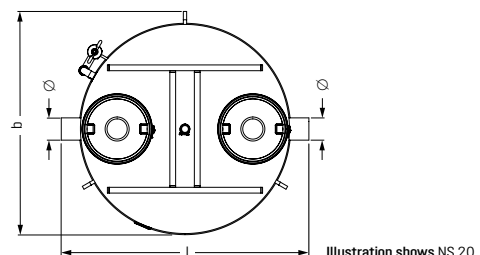
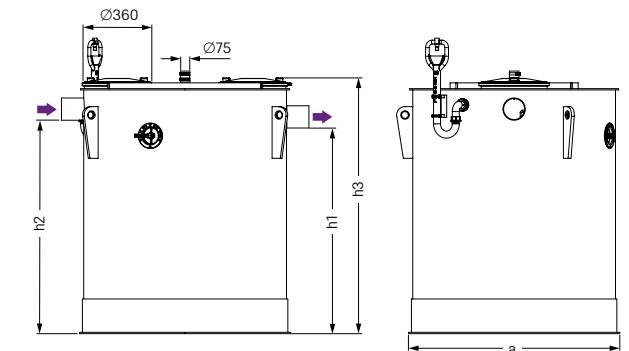
➤ **Accessories:** Inspection window and refill inlet, sampling chamber; lifting stations see chapter "3", pages 361 – 363

➤ **Technical note:** page 360



without *SonicControl*

NS	Art. no.
Without accessories	
NS 10	93 010.05/D
NS 15	93 015.05/D
NS 20	93 020.05/D



NS	Ø (mm)	a (mm)	Installation dimension l × b (mm)	h1 (mm)	h2 (mm)	h3 (mm)	Sludge trap (l)	Water and grease (l)	Grease storage (l)	Total (l)
10	160	1570	1900 × 1690	1500	1570	1910	1000	1500	400	2500
15	200	1880	2230 × 1922	1550	1620	2020	1500	2300	600	3800
20	200	1880	2230 × 1922	1850	1920	2300	2000	2650	800	4650

Ø = Outer diameter



Grease separator *EasyClean* round free Standard NS 10 – 20

for free-standing installation



EN 1825

Tank

Manufactured from virgin, non-recycled polyethylene, for free-standing installation in frost-protected areas, with integrated sludge trap, two domed covers made of polymer, with quick-release closure, sealed odour-tight. Inlet and outlet \varnothing 160 / 200 mm for the connection to PE-HD pipes according to DIN 19537, HT pipes according to DIN 19560, PP or AS.

Disposal System

Standard version requires disposal truck with vacuum system for separator disposal.

Delivery: System completely assembled.

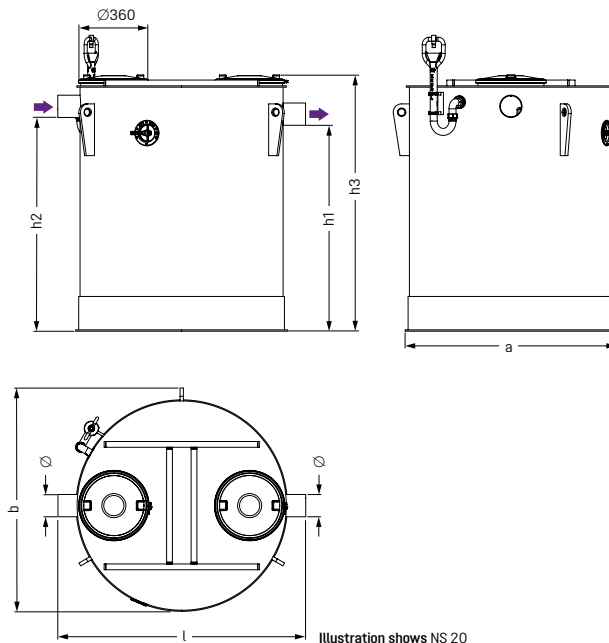
➤ **Accessories:** Inspection window and refill inlet, sampling chamber; lifting stations see chapter "3", pages 361 – 363

➤ **Technical note:** page 360



without SonicControl

NS	Art. no.
<i>Without accessories</i>	
NS 10	93 010.05
NS 15	93 015.05
NS 20	93 020.05



NS	\varnothing (mm)	a (mm)	Installation dimension l × b (mm)	h1 (mm)	h2 (mm)	h3 (mm)	Sludge trap (l)	Water and grease (l)	Grease storage (l)	Total (l)
10	160	1570	1900 × 1690	1500	1570	1910	1000	1500	400	2500
15	200	1880	2230 × 1922	1550	1620	2020	1500	2300	600	3800
20	200	1880	2230 × 1922	1850	1920	2300	2000	2650	800	4650

\varnothing = Outer diameter



Grease separator *EasyClean* free Basic

The economic solution for wastewater treatment in kitchens

The *EasyClean* free Basic grease separator is the latest model in our quality separator series. It has been developed to satisfy all of the requirements of modern wastewater technology at a market entry price level.

The result is a separator made of durable polyethylene, which is still working reliably even decades after its installation. It is available with two disposal options. In addition to the standard version, there is a Direct version, which has a convenient direct disposal connection. With the help of this, the disposal of the

separator content can be done completely odourless over a permanently installed disposal line. Both versions can be ordered with practical accessories, such as an inspection window or a refill inlet, and thus adapt perfectly to the requirements on site.

The *EasyClean* free Basic is the new standard and **economic solution** for wastewater treatment in kitchens and food processing facilities.

Made in Germany! Made by KESSEL!

Different disposal options

Direct

➔ Page 356



➊ Grease separator *EasyClean* free Basic Direct ➋ Odorless discharge is via a permanently installed discharge line ➌ Refill inlet ➍ Inspection window ➎ Sampling chamber ➏ Lifting station

Standard

➔ Page 357



➊ Grease separator *EasyClean* free Basic Standard ➋ Emptying takes place by opening the separator ➌ Refill inlet ➍ Inspection window ➎ Sampling chamber ➏ Lifting station

Direct disposal

Enables the extraction of the grease separator contents through a permanently installed odour free disposal pipe without opening the tank covers (Direct version).

Quick release access covers

Slanted twin access covers with quick release odour tight snap closures for quick and easy maintenance and cleaning.

100 % corrosion free polyethylene body

The polyethylene material used is resistant to aggressive fatty acids – and therefore particularly durable. In addition to the statutory provision, we provide a 20-year warranty with regard to the leak tightness and structural safety of tanks and upper sections.

Perfect cleaning results

Integrated sloped base allows wastewater to flow with gravity directly to the suction intake – saving time and disposal costs.



Grease separators *EasyClean* free Basic Direct NS 2 – 10 for free-standing installation



EN 1825 Z-54.1-474

- Service side ... (left/right)
- Inspection window (with/without)
- Refill inlet (with/without)

The separator for grease contaminated wastewater is suitable for free-standing installation in frost protected areas and contains no metal parts in the chamber. The separator chamber made of resistant polymer (PE) includes an integrated sludge trap. Two odour-tight covers with quick-release closures allow easy access for cleaning and maintenance tasks. For odour-reducing manual disposal, with factory installed pressure pipe suction outlet. After disposal, only approx. 3 L of residual sludge volume remains in the tank.

Warranty for polyethylene material: 20 years

Standard: EN 1825

Connection of inlet/outlet fittings: PE-HD pipes according to DIN 19537, HT pipes according to DIN 19560 (PP or AS piping)

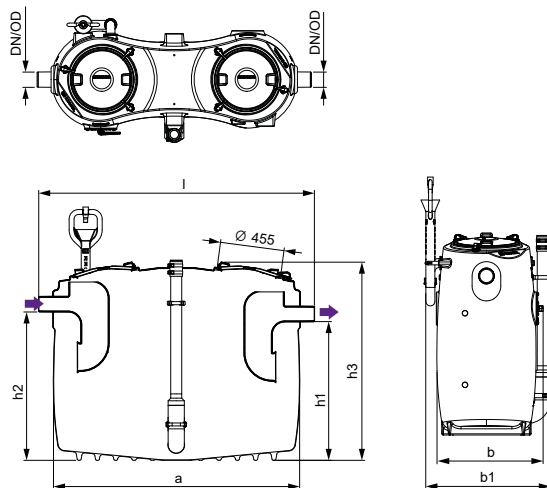
Disposal connection DN(OD): 65 (75 mm) PN10

Delivery: System completely assembled.

- **Accessories:** Sampling chamber page 361
- **Technical note:** page 360



Illustration shows Art. no. 94 004.32DR



NS	Direction of flow "left"	Direction of flow "right"
	Art. no.	Art. no.
Without accessories		
NS 2	94 002.10DL	94 002.10DR
NS 4	94 004.10DL	94 004.10DR
NS 7	94 007.10DL	94 007.10DR
NS 10	94 010.10DL	94 010.10DR
With inspection window		
NS 2	94 002.21DL	94 002.21DR
NS 4	94 004.21DL	94 004.21DR
NS 7	94 007.21DL	94 007.21DR
NS 10	94 010.21DL	94 010.21DR
With refill inlet		
NS 2	94 002.12DL	94 002.12DR
NS 4	94 004.12DL	94 004.12DR
NS 7	94 007.12DL	94 007.12DR
NS 10	94 010.12DL	94 010.12DR
With inspection window and refill inlet		
NS 2	94 002.32DL	94 002.32DR
NS 4	94 004.32DL	94 004.32DR
NS 7	94 007.32DL	94 007.32DR
NS 10	94 010.32DL	94 010.32DR

NS	Outer diameter Ø (mm)	Installation dimension l × b (mm)	b1 (mm)	h1 (mm)	h2 (mm)	h3 (mm)	Weight (kg)	Sludge trap (l)	Water and grease (l)	Grease storage (l)	Total (l)
2	110	1560 × 700	920	985	1055	1420	85	200	460	80	660
4	110	1960 × 700	905	985	1055	1420	105	400	420	160	820
7	160	1960 × 920	1140	1185	1255	1670	155	700	670	280	1370
10	160	2610 × 920	1120	1185	1255	1670	175	1000	880	400	1880

Ø = Outer diameter b1 = Set-up dimensions

Grease separators *EasyClean* free Basic Standard NS 2 – 10

for free-standing installation



EN 1825 Z-54.1-474

Service side ... (left/right)
 Inspection window (with/without)
 Refill inlet (with/without)

The separator for grease contaminated wastewater is suitable for free-standing installation in frost protected areas and contains no metal parts in the chamber. The separator chamber made of resistant polymer (PE) includes an integrated sludge trap. Two odour-tight covers with quick-release closures allow easy access for cleaning and maintenance tasks. Requires disposal truck with vacuum system. The tank cover is opened during manual disposal.

Warranty for polyethylene material: 20 years

Standard: EN 1825

Connection of inlet/outlet fittings: PE-HD pipes according to DIN 19537, HT pipe according to DIN 19560 (PP or AS piping)

Delivery: System completely assembled.

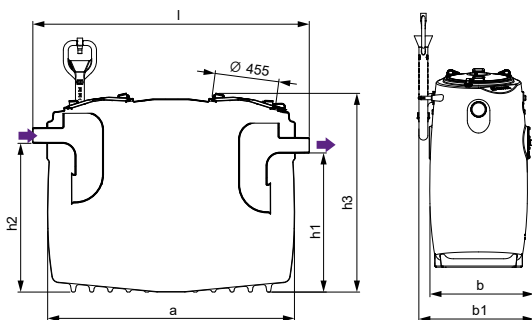
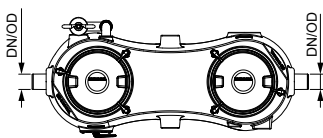
➤ **Accessories:** Sampling chamber page 361

➤ **Technical note:** page 360



Illustration shows Art. no. 94 004.32R

	Direction of flow "left"	Direction of flow "right"
NS	Art. no.	Art. no.
Without accessories		
NS 2	94 002.10	94 002.10
NS 4	94 004.10	94 004.10
NS 7	94 007.10	94 007.10
NS 10	94 010.10	94 010.10
With inspection window		
NS 2	94 002.21L	94 002.21R
NS 4	94 004.21L	94 004.21R
NS 7	94 007.21L	94 007.21R
NS 10	94 010.21L	94 010.21R
With refill inlet		
NS 2	94 002.12L	94 002.12R
NS 4	94 004.12L	94 004.12R
NS 7	94 007.12L	94 007.12R
NS 10	94 010.12L	94 010.12R
With inspection window and refill inlet		
NS 2	94 002.32L	94 002.32R
NS 4	94 004.32L	94 004.32R
NS 7	94 007.32L	94 007.32R
NS 10	94 010.32L	94 010.32R



NS	Outer diameter Ø (mm)	Installation dimension l × b (mm)	b1 (mm)	h1 (mm)	h2 (mm)	h3 (mm)	Weight (kg)	Sludge trap (l)	Water and grease (l)	Grease storage (l)	Total (l)
2	110	1560 × 700	850	985	1055	1420	80	200	460	80	660
4	110	1960 × 700	850	985	1055	1420	100	400	420	160	820
7	160	1960 × 920	1080	1185	1255	1670	150	700	670	280	1370
10	160	2610 × 920	1080	1185	1255	1670	170	1000	880	400	1880

Ø = Outer diameter b1 = Set-up dimensions

Grease separators

EasyClean Modular

The flexible solution for limited access / narrow entry.

The *EasyClean* Modular combines the advantages of the *EasyClean* free with maximum transportability. It is the ideal grease separator for extremely narrow entranceways that can make it difficult to transport a standard grease separator to the set-up location. This grease separator can be disassembled into small individual components and assembled at the set-up location.

Always the right choice:
kessel.com/smartselect

Different disposal options

Standard [↗ Page 359](#)

Direct [↗ Page 359](#)



① Lifting Station ② Assembled grease separator ③ Direct disposal connection

Grease separator *EasyClean Modular* Standard and Direct NS 1 – 4



for free-standing installation, two component version

EN 1825

Made of polyethylene PE-HD

Installation: In frost-protected rooms

Version: Can be disassembled

Delivery: System completely assembled (only NS 1)

Note for NS 1: The separated grease must be skimmed off daily in the case of weekly emptying and cleaning.

Custom made product: Delivery time on request

➤ **Accessories for NS 2 / NS 3 / NS 4:** Sampling chamber, refill inlet, inspection window, *SonicControl* from page 361 – 363, lifting stations see chapter "3"



Illustration shows Art. no. 93 001



Illustration shows Art. no. 93 002-R

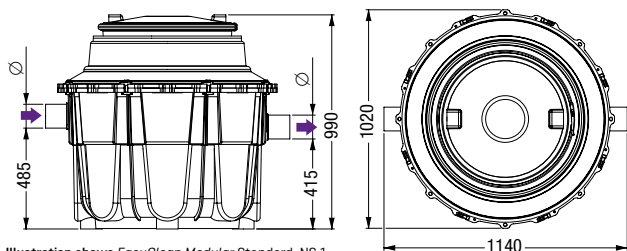


Illustration shows *EasyClean Modular* Standard, NS 1

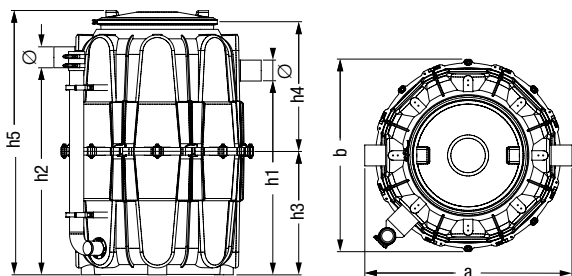


Illustration shows *EasyClean Modular* Direct, NS 3

EasyClean Modular Standard

NS	Art. no.
NS 1	93 001
NS 2	93 002-R
NS 3	93 003-R
NS 4	93 004-R

EasyClean Modular Direct with direct disposal

NS	Art. no.
NS 2	93 002.00/D1-R
NS 3	93 003.00/D1-R
NS 4	93 004.00/D1-R

NS	Ø (mm)	a (mm)	b (mm)	h1 (mm)	h2 (mm)	h3 (mm)	h4 (mm)	h5 (mm)	Weight (kg)	Sludge trap (l)	Water and grease (l)	Grease storage (l)	Total (l)
1	110								65	100	100	40	200
2	110	1100	1020	1020	1090	650	690	1395	60	200	400	100	600
3	110	1100	1020	1020	1090	650	690	1395	60	300	300	120	600
4	110	1400	1300	1090	1160	765	790	1620	110	400	560	160	960

Ø = Outer diameter h4 × b = access opening

Grease separator *EasyClean Modular* Standard and Direct NS 1 – 4

for free-standing installation, three component version



Made of polyethylene PE-HD

Installation: In frost-protected rooms

Version: Standard or with direct disposal (only *EasyClean Modular Direct*)

Consisting of: Integrated sludge trap, polyethylene quick release odour tight covers

Delivery: System completely assembled. Screw connection can be undone to minimum installation dimensions.

Installation:

Ideal where access is extremely narrow.

Separator can be disassembled into 3 parts for installation opening of max. 58 cm.

Further nominal sizes, models with disposal device and on-site welding on request: info@kessel.com

Custom made product: Delivery time on request

➤ **Accessories:** Sampling chamber, *SonicControl*, refill inlet, from page 361 – 363, lifting stations see chapter "3"



EasyClean Modular Standard

NS	Art. no.
NS 1	93 001-R2-TS
NS 2	93 002-R2-TS
NS 3	93 003-R2-TS
NS 4	93 004-R2-TS

EasyClean Modular Direct with direct disposal

NS	Art. no.
NS 1	93 001-D1-R2-TS
NS 2	93 002-D1-R2-TS
NS 3	93 003-D1-R2-TS
NS 4	93 004-D1-R2-TS

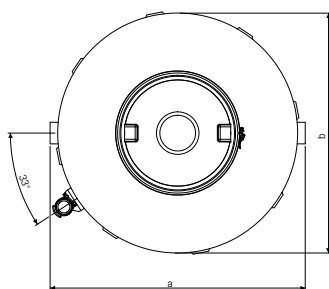
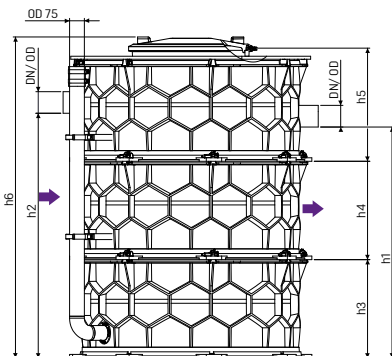


Illustration shows Direct version

Technical note for pages 336 – 360

Production and weather related influences can lead to deviations from our specifications in the case of free-standing separators. For this reason, please check the height specifications in particular for their actual size before installation. Please adapt the pipework to the actual inlet and outlet dimensions before installing the grease separator. Thermal and mechanical influences must be taken into consideration.

NS	Ø (mm)	a (mm)	b (mm)	h1 (mm)	h2 (mm)	h3 (mm)	h4 (mm)	h5 (mm)	h6 (mm)	Weight (kg)	Sludge trap (l)	Water and grease (l)	Grease storage (l)	Total (l)
1	110	1300	1240	600	670	550	580		1133	95	100	380	80	330
2	110	1300	1240	715	785	550	580		1133	85	200	380	100	470
3	110	1300	1240	885	955	550	300	580	1383	110	300	420	120	600
4	110	1300	1240	1175	1245	550	550	580	1633	120	400	560	160	960

Ø = Outer diameter h5 × b = access opening



Accessories

Grease separators for free-standing installation

Sampling chamber Ø 400		Outer diameter Ø (mm)	Length in mm	Art. no.	
Outlet lateral	<p>Compatibility: For connection to outlet pipe of separator, no ponding (allows accurate samples). Inlet and outlet Ø ... available options for synthetic material pipes in: PE-HD (according to EN 1519-1); PVC-HT, PP or AS; for grease separators for free-standing installation</p> <p>Inclusive: Cover sealed odour-tight with snap closure</p> <p>Drop height: 120 mm</p>		Ø 110/Ø 160	750	915 871
			Ø 200	780	915 883
			Ø 250	860	915 884

Outlet vertical	<p>Compatibility: For connection to outlet pipe of separator, no ponding (allows accurate samples). Inlet and outlet Ø ... available options for synthetic material pipes in: PE-HD (according to EN 1519-1); PVC-HT, PP or AS; for grease separators for free-standing installation</p> <p>Inclusive: Cover sealed odour-tight with snap closure</p> <p>Drop height: 120 mm</p>		Ø 110/Ø 160	915 870
------------------------	---	--	-------------	---------

Sampling chamber Ø 450		Outer diameter Ø (mm)	Art. no.	
Outlet lateral	<p>Compatibility: For connection to outlet pipe of separator. Inlet and outlet Ø 200 mm available options for synthetic material pipes in: PE-HD (according to EN 1519-1); PVC-HT, PP or AS; for grease separators for free-standing installation</p> <p>Inclusive: Cover sealed odour-tight with snap closure</p> <p>Drop height: 160 mm</p>		Ø 200	915 863-IS

Distribution box		Outer diameter Ø (mm)	Art. no.	
Distribution box	<p>Compatibility: For twin (parallel) separator systems; for grease separators for free-standing installation</p> <p>Inclusive: With inlet and outlet connection for polymer pipes made of: PE-HD (according to DIN 19537); PVC-HT, PP or AS.</p>		Ø 110 Ø 160 Ø 200	915 700-100 915 700-150 915 700-200

Automated water refill <i>EasyFill</i>		Art. no.
--	--	----------

Automated water refill <i>EasyFill</i>	<p>Compatibility: For grease separator <i>EasyClean</i> Standard, Direct, Mix, Mix & Pump according to EN 1825</p>	919 010
---	---	---------

Accessories

Grease separators for free-standing installation

SonicControl level sensing system

Art. no.

level sensing system

Compatibility: For grease separators for free-standing installation according to EN 1825

Inclusive: Ultra sonic sensor for electronic measurement, display and control of the grease layer thickness and the water temperature; power connection, battery back up, connection for remote speaker; installation set with easy assembly and maintenance; control unit with optical and audible alarm with potential free contact; electronic log book with 12 month capacity. Data transfer by telemetry.

Voltage: 230 V ~ 50 Hz

Protection type: IP 54

Plug: Schuko 1.5 m

Cable length: 10 m (extendable on-site to 60 meters)



917 821

LoRa add-on printed circuit board

Art. no.

LoRa add-on printed circuit board

Compatibility: For wireless data transfer between the SonicControl control unit and the building control system from production year 2022 or a portal by means of LoRa WAN (on site)

72 999

Cable access conduit

Art. no.

Cable access conduit

Compatibility: For grease separators according to EN 1825 and DIN 4040; for watertight connection of *SonicControl* cable into separator chamber

Inclusive: Gasket, cable connection, extension, sensor bracket

Note: Conduit pipe with chase wire should be planned; requires 50 mm OD conduit pipe (PE-HD) -sourced on-site. Max. distance 30 m



917 823

Cable extension set for *SonicControl FA*

Art. no.

10 m extension

917 871

20 m extension

917 872

30 m extension

917 873

extendable on-site to 60 meters



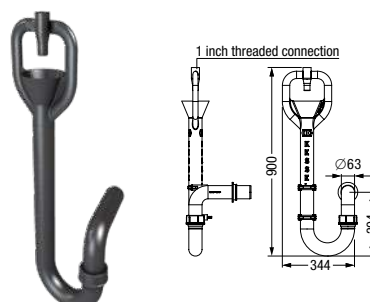
Refill inlet

Art. no.

Refill inlet

Compatibility: According to DIN 1988, for connection to filling and rinsing connection of the separation systems for free-standing installation according to EN 1825

Inclusive: Two pipe clamps, element with pipe sealing gasket Ø 63



915 800

Accessories

Grease separators for free-standing installation

Inspection window

Art. no.

Inspection window

Compatibility: For visual inspection of the thickness of the grease layer; for grease separators for free-standing installation according to EN 1825
Inclusive: High-gloss polished inspection glass, cleaning device, centimetre scale
Note: Only for installation by KESSEL certified workers



913 109

Remote control

Art. no.

Remote control

Compatibility: Fits KESSEL separation systems for free standing installation according to EN 1825, for connection to an isolated ground socket
Version: Model Auto Mix & Pump and Auto Mix in accordance with EN 1825
Cable length: 15 m



916 601

Access panel

Width×Height×Depth
in mm

Art. no.

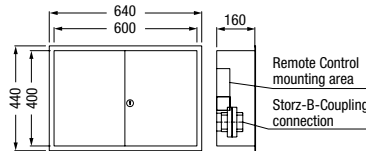
Recessed wall installation

Compatibility: For Storz-B disposal pipe hook up connection and remote control connection for use with fully automated grease separators. Remote control not included
Material: Stainless steel
Inclusive: 2 doors, lockable
Note: Special dimensions on request



640×440×160

917 414



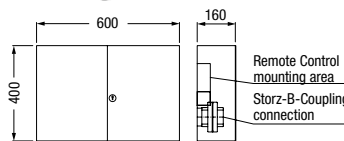
Wall installation

Compatibility: For Storz-B disposal pipe hook up connection and remote control connection for use with fully automated grease separators. Remote control not included
Material: Stainless steel
Inclusive: 2 doors, lockable
Note: Special dimensions on request



600×400×160

917 413



Progressive cavity pump

for greasy wastewater

Material: Polyethylene PE-HD

Version: upstream from the grease separator

Custom made product: e-Mail: info@kessel.com

Application: In the case where the grease separator is located higher than the collected wastewater from the kitchen, the EN 1825 norm requires the use of special lifting stations. Standard lifting stations with vortex or macerating pumps mix the wastewater as it is pumped. This causes the food waste and grease from the kitchen to fully mix with the wastewater which can negatively effect the efficiency of an EN 1825 grease separator. A progressive cavity pump 'pushes' the wastewater into the grease separator, without any mixing taking place, allowing for proper grease separator operation.

For additional information concerning Kessel positive displacement pumps, please contact KESSEL directly.



Illustration shows screw pump double system

- 1 Drains in the kitchen
- 2 Inlet pipe
- 3 Collecting tank
- 4 Progressive cavity pump twin system
- 5 Control unit
- 6 Pressure pipe
- 7 Calmed inlet (min. 1000 mm)
- 8 Grease separator
- 9 Sampling chamber



	Art. no.	Flow rate	Pump capacity	Connection	Suitable up to NS
Duo-Progressive cavity pump	Sonder-Hebe 65 S2	6 m ³ /h	1.1 kW	DN65/DN80	NS 4
Duo-Progressive cavity pump	Sonder-Hebe 65 S3	12 m ³ /h	2.2 kW	DN80/DN100	NS 7
Duo-Progressive cavity pump	Sonder-Hebe 65S	20 m ³ /h	3.0 kW	DN80/DN100	NS 15
Duo-Progressive pump	Sonder-Hebe 65 S4	44 m ³ /h	7.5 kW	DN 125	NS 30

Accessories

Gate valve DN 65-DN 100	28 041	-	-	-	-
Non-return flap DN 65-DN 100	(included)	-	-	-	-
Mono-pump system	on request	-	-	-	-

Grease separator

EasyClean free Self Disposal

Recycling and reselling of FOG (Fats, Oils and Grease) is the new method of meeting local wastewater regulations, protecting the environment and recycling /selling the collected FOG.

The KESSEL *Self disposal grease separator* is designed exactly for this purpose. The EN 1825 certified separator separates food sludge and oil / grease from the kitchen wastewater which is then drained into included 60 liter storage tanks. The collected sludge and oil / grease in the tanks is then sold locally to a recycling company or disposed of as bio-waste. No need to hire a disposal truck to empty the grease separator on a monthly basis.

Advantages

- Regular disposal of grease and sludge even during separator operation
- Separate disposal of grease and sludge
- Environmentally friendly recycling of collected waste
- Disposal costs reduced since clean water remains in separator, only grease and sludge are removed
- Disposal requires no additional water for rinsing, cleaning or re-filling which saves valuable drinking water
- On-site assembly available

100 % corrosion-free

The *SE grease separator* is made from fully corrosion free polyethylene – guaranteed to last 20 years.

Separate oil / grease and food sludge collection

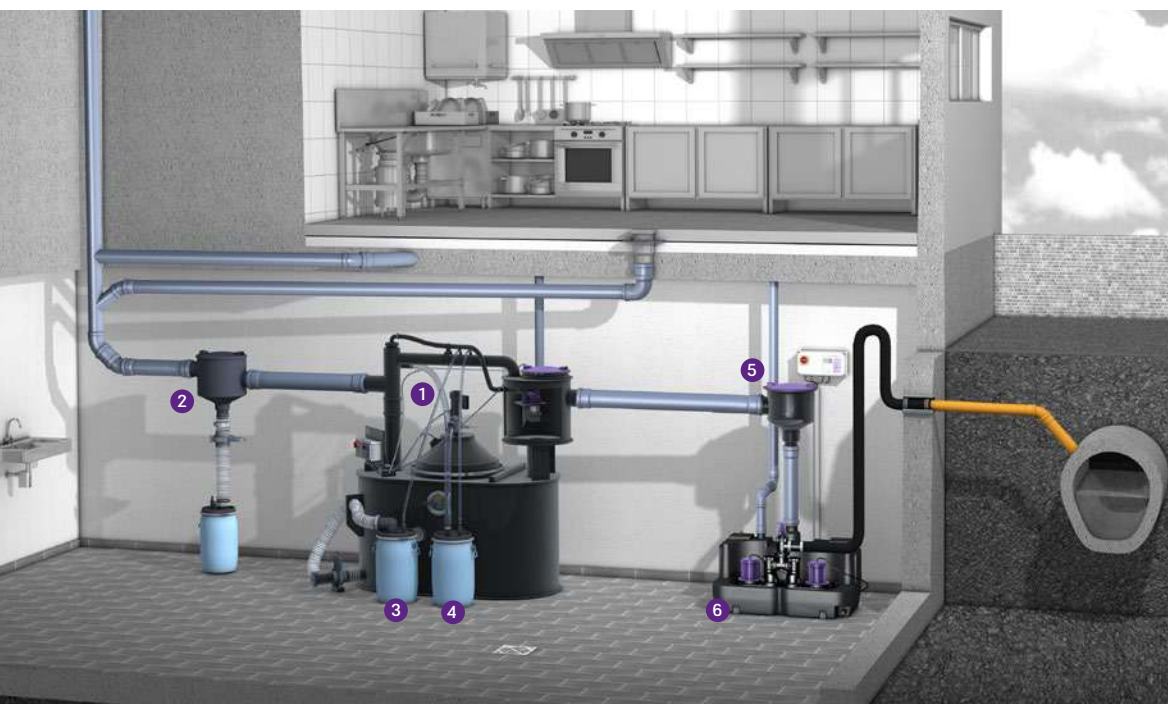
Separator has integrated food sludge collection and separate integrated oil / grease collection areas – meaning no mixed waste in the 60 liter storage tanks. 60 liter storage tanks are filled with either food waste OR oils / grease – for easy resale or recycling.

Heating dome

Separators equipped with integrated heating dome to pre-heat oils and greases before draining into 60 liter tank. Pre-heat timing is custom set so that greases / oils are properly liquified before draining into tanks.

Ideal for no access disposal truck locations

Separators are ideal for installations where there is no access for disposal trucks – for example island vacation resorts and mountain ski resorts.



1 Grease separator 2 Pre-filter 3 Sludge storage tank 4 Grease storage tank 5 Sampling chamber 6 Lifting station

Grease separator *EasyClean free Self Disposal NS 2 – 10*

for free-standing installation



Grease Separator according to EN 1825/DIN 4040, manufactured of High Density Polyethylene (HD-PE), for free standing installation in frost free rooms, odor tight access covers with quick release clamps, odor tight grease separation compartment with integrated heating dome.

Ø 110/160 inlet and outlet.

Self disposal system for separate disposal/collection of sludge and grease via manually operating valves. Visual inspection with transparent disposal pipe, disposal possible without interrupting separator operation. Includes grease, sinking sludge tanks (each with replacement tanks).

Electrical heating dome (230V, 50 Hz, 1200 W) for grease separation compartment and motor operated grease mixer (230 V, 50 Hz, 360 W) and electrical control unit (230V, 50 Hz, 6.3-10 Amp), rinsing pump (230V, 50 Hz, 1400 W).

Complete system is IP 54 rated.

System delivered completely assembled.

Rights reserved for technical changes.

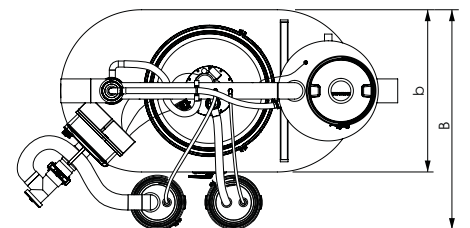
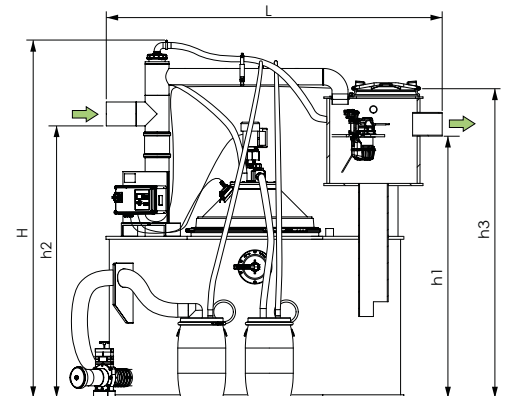
- **Required accessories:** Sludge pre-filter
- **Accessories:** Sampling Chamber, Lifting Stations



Nominal sizes

Art. no.

NS 2	99 102.02
NS 4	99 104.02
NS 7	99 107.02
NS 10	99 110.02



NS	Flow rate	Ø (mm)	H (mm)	L (mm)	B (mm)	b (mm)	h1 (mm)	h2 (mm)	h3 (mm)	Weight empty (kg)	Weight full (kg)
2	2 l/s	110	2350	2350	1580	1086	1775	1845	2060	270	1675
4	4 l/s	110	2350	2235	1600	1086	1775	1845	2060	270	1675
7	7 l/s	160	2380	2260	1600	1086	1750	1820	2070	305	2280
10	10 l/s	160	2380	2260	1680	1166	1750	1820	2070	315	2415

Grease separator *EasyClean free Self Disposal NS 15 – 25*

for free-standing installation



Grease Separator according to EN 1825/DIN 4040, manufactured of High Density Polyethylene (HD-PE), for free standing installation in frost free rooms, with preliminary coarse sludge trap, odor tight access covers with quick release clamps, odor tight grease separation compartment with integrated heating dome.

Ø 200 inlet and outlet.

Self disposal system for separate disposal/ collection of sludge and grease via manually operating valves. Visual inspection with transparent disposal pipe, disposal possible without interrupting separator operation. Includes disposal tanks (for grease, sludge and replacement tank).

Electrical heating dome (230V, 50 Hz, 1200 W) for grease separation compartment and motor operated grease mixer (230 V, 50 Hz, 360 W) and electrical control unit (230V, 50 Hz, 6.3-10 Amp), rinsing pump (230V, 50 Hz, 1400 W).

Complete system is IP 54 rated.

System delivered completely assembled.

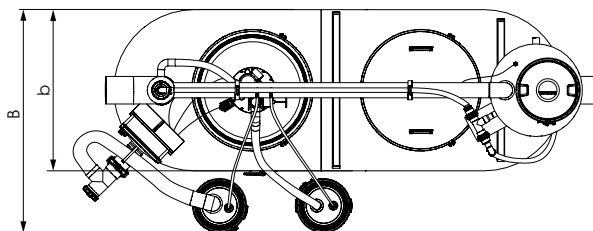
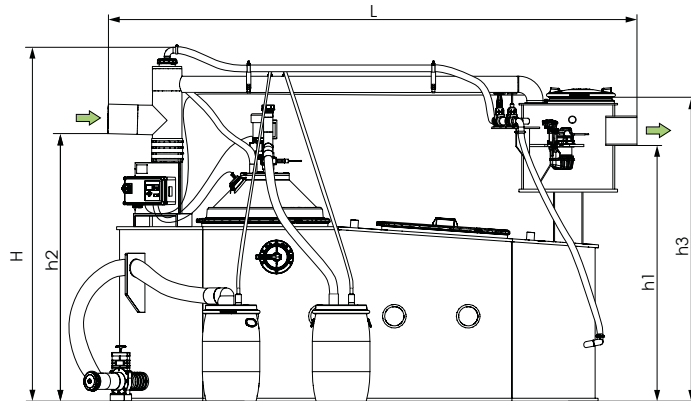
Rights reserved for technical changes.

➤ **Required accessories:** Sludge pre-filter

➤ **Accessories:** Sampling Chamber, Lifting Stations



Nominal sizes	Art. no.
NS 15	99 115.02
NS 20	99 120.02
NS 25	99 125.02



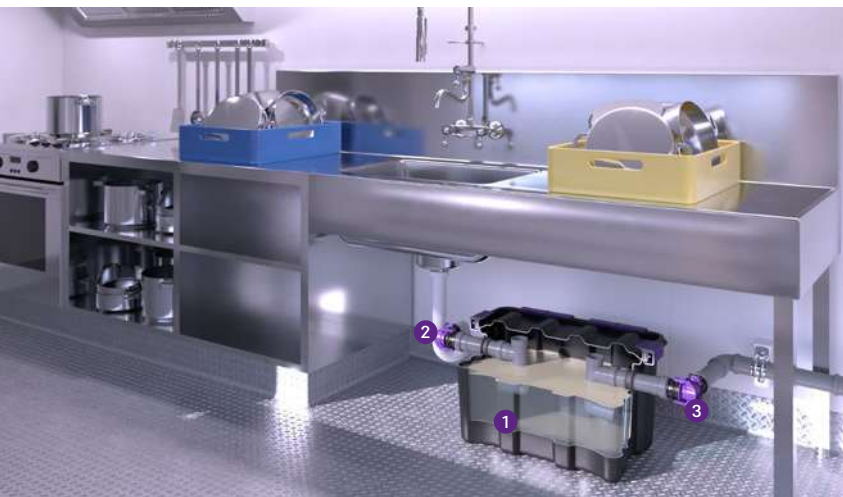
NS	Flow rate	Ø (mm)	H (mm)	L (mm)	B (mm)	b (mm)	h1 (mm)	h2 (mm)	h3 (mm)	Weight empty (kg)	Weight full (kg)
15	15 l/s	200	2350	3200	1550	1100	1730	1800	2100	370	3095
20	20 l/s	200	2350	3600	1650	1200	1730	1800	2100	440	3855
25	25 l/s	200	2350	4350	1650	1200	1730	1800	2100	530	4740

Ø = Outer diameter

Grease separator *EasyClean free UnderSink*

In the food truck, in the takeaway restaurant, in the shopping centre or in a small club: Installation of large central grease separators is not possible everywhere. If this is the case, and only small volumes of wastewater are produced, then it's a clear case for the *EasyClean free UnderSink* grease separator – optimised for free-standing set-up where space is limited.

Its low weight and compact size enable easy handling. Thanks to its 360° rotatable and vertically adjustable swivel connection, the tank is particularly convenient to remove. The *EasyClean free UnderSink* grease separator has been tested on the test bench with 0.7 l/s and is therefore ideally suitable for the wastewater discharge from a sink – efficient at a favourable price in TÜV-tested quality.



1 Grease separators 2 Inlet 3 Outlet

100 % corrosion-free

The *EasyClean free UnderSink* is 100 % made of polymer. That makes it resistant to aggressive wastewater and particularly durable.

100 % waterproof and odour-tight

The tank of the *EasyClean free UnderSink* grease separator is water and odour-tight. We vouch for this with our KESSEL guarantee: In addition to the statutory provision, we provide a 20-year warranty on the leak tightness, fitness for purpose and structural stability of tank.

Inspection window

An inspection window is available for optional installation on site for visual checking of the grease layer thickness.

Tool-free installation

KESSEL makes the installation particularly easy for you: You do not need any tools to install the *EasyClean free UnderSink* grease separator – which also applies to the disposal.



1 Grease separators 2 Lifting station



Grease separator *EasyClean free UnderSink* NS 0.7 for free-standing installation



The separator for greasy wastewater is suitable for free-standing set-up in frost-protected rooms below a sink and is manufactured without the need for metallic components in the tank. The collecting tank made of permanently resistant polymer (PP) is equipped with an integrated sludge trap. An odour-tight cover with all-round seal and clip closures makes easy access possible for cleaning and maintenance work. For easy removal, the separator has a quick-release connection to the pipe.

An inspection window for optional installation on site is available for visual checking of the grease layer thickness.

Technical data:

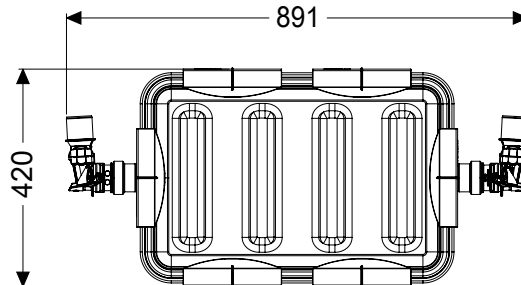
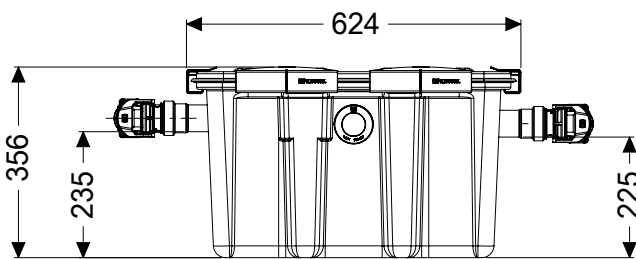
- Inlet/outlet Ø 50 mm
- Grease storage 8l
- Sludge trap 12l
- Total volume 33l

Material: PP

Delivery: Modular kit for assembly on site

Type of disposal: manual

NS	Art. no.
0.7	93 070.00US



h1 (mm)	h2 (mm)	Inlet/outlet Ø (mm)	Installation dimension l × b (mm)	Weight (kg)	Sludge trap (l)	Water and grease (l)	Grease storage (l)	Total (l)
225	235	50	891 × 420	5	12	21	8	33

Accessories

Inspection window

Inspection window

Compatibility: For grease separators *EasyClean free UnderSink* for free-standing installation

Inclusive: High-gloss polished inspection glass

Note: Installation in drillhole on site, use hole saw with DA60



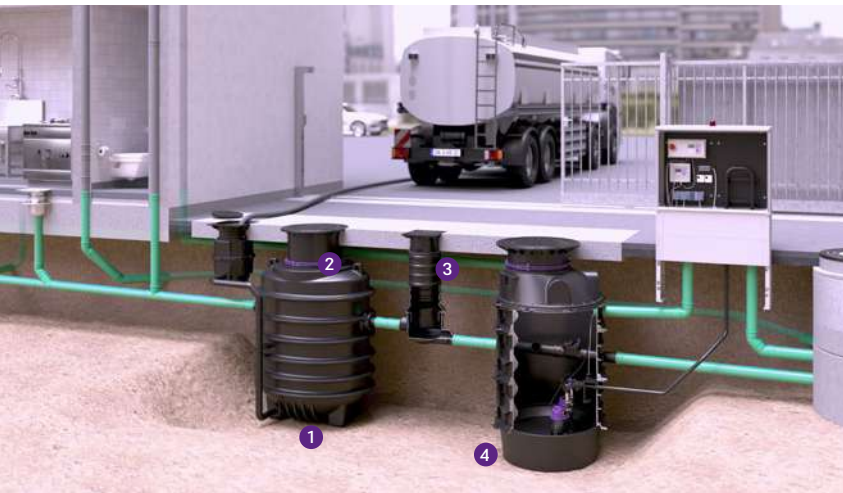
Art. no.

913 110

Grease separators *EasyClean* ground

The space-saving solution
for underground installation.

Underground installation outside the building is a space saving alternative to indoor installed separators. Here, we offer a wide range of grease separators with the *EasyClean* ground that combines the advantages of the *EasyClean* free with more usable operating space.



- 1 Grease separator
- 2 Height adjustable upper section
- 3 Disposal chamber
- 4 Pumping station



- 1 Grease separator
- 2 Height adjustable upper section
- 3 Disposal chamber



Different disposal options

Auto Mix & Pump	➤ Page 372
Auto Mix	➤ Page 373
Direct	➤ Page 374
Standard	➤ Page 376
Multi Direct, Multi Standard	➤ Page 381

EasyClean ground
complete includes tank, upper
section, cover, gaskets



Remote Control
located at the disposal truck
connection (option for PVS and
DSP)



Lock & Lift
lockable odour tight manhole cover
with easy release technology

Fully certified according to EN
800 mm access by health and
safety – all installation depth
provides easy service/inspection

Upper sections
vertical adjustable



Warranty
KESSEL offers a factory extended
warranty of 20 years on the
polyethylene grease separator tanks.

Cable conduit
water/odour tight chamber
sealing system for Sonic-Control
sensor cable



Groundwater resistance
up to manhole cover NS 7-12.5
(others on demand)



SonicControl
for the measurement, display and
control of the grease layer thickness
includes clip-on installation bracket

Grease separator *EasyClean* ground Auto Mix & Pump NS 1 – 10

for underground installation



EN 1825 DIN 4040-100

Made of polyethylene

Installation

In combination with engineering system chamber

- Grease Separator NS 1 – 4: Resistant when installed in the groundwater up to 500 mm
- Grease Separator NS 7, 10: Resistant when installed in the groundwater up to 500 mm
- A load distribution plate must be planned for class D

Consisting of: With program-controlled disposal system and Shredder-Mix system, upper section made of polymer material, continuous height and level adjustment, with cover, class A / B, D (class D with *Lock & Lift* function) according to EN 124 made of cast iron (can be driven over by cars and trucks), sealed odour-tight, incl. removal mechanism, integrated sampling chamber *Type NBG*, control unit (potential free contact and Modbus) and remote control, mains water supply rinse function, refill inlet, pump

Pumping capacity: 3.0 kW

Cable length: 5 m

Delivery: System completely assembled

Note: Further nominal sizes on request

- **Accessories:** Jointing / connection set, disposal chamber Ø 400, sampling chamber, intermediate section, *SonicControl* page 382 – 385, pumping stations see chapter "3"

- **Technical note:** page 379

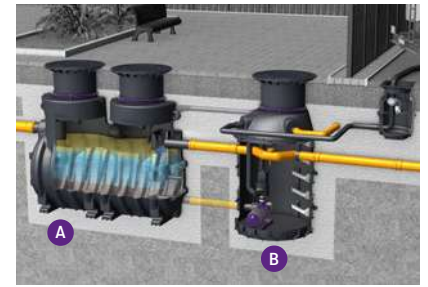


Illustration shows NS 10, NS 4

Underground installation frost-free depth 1200 mm

NS	Installation depth D in mm	Art. no.
Cover class A/B		
NS 1	725 - 1225	93 001/120B-PVS-TS
NS 2	725 - 1225	93 002/120B-PVS-TS
NS 4	725 - 1225	93 004/120B-PVS-TS
NS 7	680 - 1190	93 007/120B-PVS-TS
NS 10	680 - 1190	93 010/120B-PVS-TS

Cover class D, with Lock & Lift function

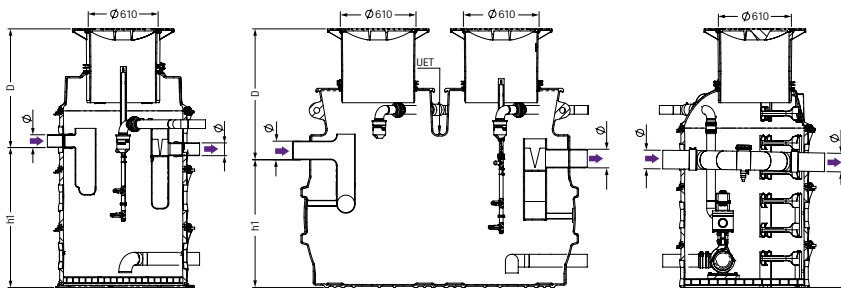
NS 1	1020 - 1225	93 001/120D-PVS-TS
NS 2	1020 - 1225	93 002/120D-PVS-TS
NS 4	1020 - 1225	93 004/120D-PVS-TS
NS 7	975 - 1190	93 007/120D-PVS-TS
NS 10	975 - 1190	93 010/120D-PVS-TS

Underground installation frost-free depth 1700 mm

NS	Installation depth D in mm	Art. no.
Cover class A/B		
NS 1	1225 - 1725	93 001/170B-PVS-TS
NS 2	1225 - 1725	93 002/170B-PVS-TS
NS 4	1225 - 1725	93 004/170B-PVS-TS
NS 7	1180 - 1690	93 007/170B-PVS-TS
NS 10	1180 - 1690	93 010/170B-PVS-TS

Cover class D, with Lock & Lift function

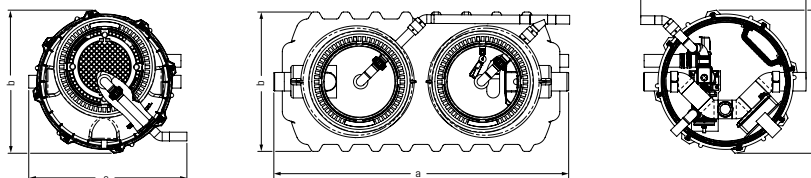
NS 1	1520 - 1725	93 001/170D-PVS-TS
NS 2	1520 - 1725	93 002/170D-PVS-TS
NS 4	1520 - 1725	93 004/170D-PVS-TS
NS 7	1475 - 1690	93 007/170D-PVS-TS
NS 10	1475 - 1690	93 010/170D-PVS-TS



A Grease separator NS 1 – 4

A Grease separator NS 7 – 10

B Grease separator



NS	Ø (mm)	a (mm)	b (mm)	a1 (mm)	b1 (mm)	h1 (mm)	h2 (mm)	Weight (kg)	Sludge trap (l)	Water and grease (l)	Grease storage (l)	Total (l)
1	110	1365	1235	1425	1235	705	595	270	140	230	70	370
2	110	1365	1235	1425	1235	955	845	300	200	370	120	570
4	110	1365	1235	1425	1235	1205	1095	325	400	370	160	770
7	160	2540	1200	1425	1235	1100	995	525	700	1100	280	1800
10	160	3065	1200	1425	1235	1100	995	550	1000	1600	400	2600



Ø = Outer diameter D = Installation depth

Grease separator *EasyClean* ground Auto Mix NS 1 – 10

for underground installation



EN 1825 DIN 4040-100

Made of polyethylene

Installation

In combination with engineering system chamber

- Grease Separator NS 1 – 4: Resistant when installed in the groundwater up to 500 mm
- Grease Separator NS 7, 10: Resistant when installed in the groundwater up to 500 mm
- A load distribution plate must be planned for class D

Consisting of: With program-controlled Shredder-Mix system, upper section made of polymer material, continuous height and level adjustment, with cover, class A / B, D (class D with *Lock & Lift* function) according to EN 124 made of cast iron (can be driven over by cars and trucks), sealed odour-tight, incl. removal mechanism, integrated sampling chamber *Type NBG*, control unit and remote control, mains water supply rinse function, refill inlet, pump

Pumping capacity: 3.0 kW

Cable length: 5 m

Delivery: System completely assembled

Note: Further nominal sizes on request

- **Accessories:** Joining / connection set, disposal chamber Ø 400, sampling chamber, intermediate section, *SonicControl* page 382 – 385, pumping stations see chapter "3"

➤ **Technical note:** page 379

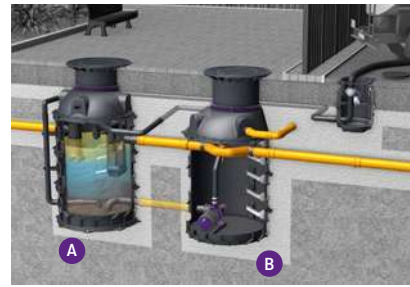


Illustration shows NS 2, NS 4

Underground installation frost-free depth 1200 mm

NS	Installation depth D in mm	Art. no.
Cover class A / B		
NS 1	725 - 1225	93 001/120B-DSP-TS
NS 2	725 - 1225	93 002/120B-DSP-TS
NS 4	725 - 1225	93 004/120B-DSP-TS
NS 7	680 - 1190	93 007/120B-DSP-TS
NS 10	680 - 1190	93 010/120B-DSP-TS

Cover class D, with *Lock & Lift* function

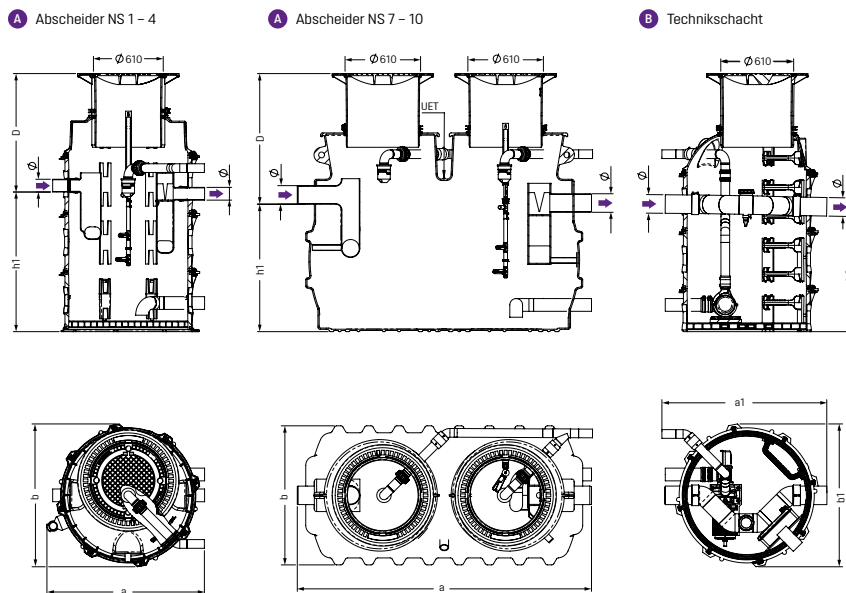
NS 1	1020 - 1225	93 001/120D-DSP-TS
NS 2	1020 - 1225	93 002/120D-DSP-TS
NS 4	1020 - 1225	93 004/120D-DSP-TS
NS 7	975 - 1190	93 007/120D-DSP-TS
NS 10	975 - 1190	93 010/120D-DSP-TS

Underground installation frost-free depth 1700 mm

NS	Installation depth D in mm	Art. no.
Cover class A / B		
NS 1	1225 - 1725	93 001/170B-DSP-TS
NS 2	1225 - 1725	93 002/170B-DSP-TS
NS 4	1225 - 1725	93 004/170B-DSP-TS
NS 7	1180 - 1690	93 007/170B-DSP-TS
NS 10	1180 - 1690	93 010/170B-DSP-TS

Cover class D, with *Lock & Lift* function

NS 1	1520 - 1725	93 001/170D-DSP-TS
NS 2	1520 - 1725	93 002/170D-DSP-TS
NS 4	1520 - 1725	93 004/170D-DSP-TS
NS 7	1475 - 1690	93 007/170D-DSP-TS
NS 10	1475 - 1690	93 010/170D-DSP-TS



NS	Ø (mm)	a (mm)	b (mm)	a1 (mm)	b1 (mm)	h1 (mm)	Weight (kg)	Sludge trap (l)	Water and grease (l)	Grease storage (l)	Total (l)
1	110	1365	1235	1425	1235	705	270	140	230	70	370
2	110	1365	1235	1425	1235	955	300	200	370	120	570
4	110	1365	1235	1425	1235	1205	325	400	370	160	770
7	160	2540	1200	1425	1235	1100	525	700	1100	280	1800
10	160	3065	1200	1425	1235	1100	550	1000	1600	400	2600

Ø = Outer diameter D = Installation depth



Grease separator *EasyClean* ground Direct NS 1 – 12,5 for underground installation

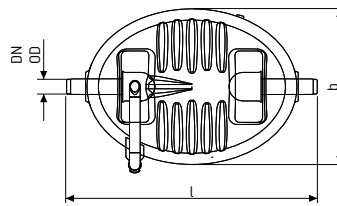
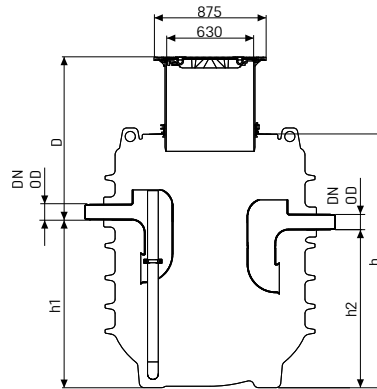


EN 1825 DIN 4040-100

The separator for greasy wastewater is suitable for installation in the ground and comes without metallic components in the tank. The collecting tank made of permanently resistant polymer (PE) is equipped with an integrated sludge trap and has a rounded base for fast and clean disposal. Access for cleaning and maintenance work is possible via a service access cover. A direct disposal pipe socket is available for manual disposal. A load distribution slab must be installed on site for load class D. The reinforcement drawings are part of the EBA and are available from KESSEL AG. The tank is groundwater resistant up to ground level (GL). 20 year polyethylene warranty.

➤ **Accessories:** Sampling chamber, extension section, *SonicControl* page 382 – 385, pumping stations see chapter "3"

➤ **Technical note:** page 379



NS	Ø (mm)	l (mm)	b (mm)	h (mm)	h1 (mm)	h2 (mm)	Weight (kg)	Sludge trap (l)	Water and grease (l)	Grease storage (l)	Total (l)
1	100	1700	1090	1515	870	800	215	100	550	40	650
2	100	1700	1090	1515	870	800	215	200	450	80	650
3	100	1700	1090	1820	1175	1105	230	300	615	120	915
4	100	1700	1090	1820	1175	1105	230	400	515	160	915
7	150	1870	1090	2375	1705	1635	305	700	930	280	1630
8,5	150	1870	1090	2375	1755	1685	305	850	850	340	1700
10	150	1870	1090	2795	2170	2100	345	1000	1100	400	2100
12,5	200	1870	1090	2795	2135	2065	350	1250	880	500	2130

Ø = Outer diameter

D = Installation depth

Underground installation frost-free depth 1200 mm

NS	Installation depth in mm	Direction of flow "left" Art. no.	Direction of flow "right" Art. no.
----	--------------------------	-----------------------------------	------------------------------------

Cover class B

NS 1	690 - 1190	95 010-120B-DL	95 010-120B-DR
NS 2	690 - 1190	95 020-120B-DL	95 020-120B-DR
NS 3	690 - 1190	95 030-120B-DL	95 030-120B-DR
NS 4	690 - 1190	95 040-120B-DL	95 040-120B-DR
NS 7	715 - 1215	95 070-120B-DL	95 070-120B-DR
NS 8,5	665 - 1165	95 085-120B-DL	95 085-120B-DR
NS 10	670 - 1170	95 100-120B-DL	95 100-120B-DR
NS 12,5	645 - 1145	95 125-120B-DL	95 125-120B-DR

Cover class D, with Lock & Lift function

NS 1	900 - 1190	95 010-120D-DL	95 010-120D-DR
NS 2	900 - 1190	95 020-120D-DL	95 020-120D-DR
NS 3	900 - 1190	95 030-120D-DL	95 030-120D-DR
NS 4	900 - 1190	95 040-120D-DL	95 040-120D-DR
NS 7	925 - 1215	95 070-120D-DL	95 070-120D-DR
NS 8,5	875 - 1165	95 085-120D-DL	95 085-120D-DR
NS 10	880 - 1170	95 100-120D-DL	95 100-120D-DR
NS 12,5	855 - 1145	95 125-120D-DL	95 125-120D-DR

Underground installation frost-free depth 1700 mm

NS	Installation depth D in mm	Direction of flow "left" Art. no.	Direction of flow "right" Art. no.
----	----------------------------	-----------------------------------	------------------------------------

Cover class B

NS 1	1040 - 1740	95 010-170B-DL	95 010-170B-DR
NS 2	1040 - 1740	95 020-170B-DL	95 020-170B-DR
NS 3	1040 - 1740	95 030-170B-DL	95 030-170B-DR
NS 4	1040 - 1740	95 040-170B-DL	95 040-170B-DR
NS 7	1065 - 1765	95 070-170B-DL	95 070-170B-DR
NS 8,5	1015 - 1715	95 085-170B-DL	95 085-170B-DR
NS 10	1020 - 1720	95 100-170B-DL	95 100-170B-DR
NS 12,5	995 - 1740	95 125-170B-DL	95 125-170B-DR

Cover class D, with Lock & Lift function

NS 1	1190 - 1740	95 010-170D-DL	95 010-170D-DR
NS 2	1190 - 1740	95 020-170D-DL	95 020-170D-DR
NS 3	1190 - 1740	95 030-170D-DL	95 030-170D-DR
NS 4	1190 - 1740	95 040-170D-DL	95 040-170D-DR
NS 7	1215 - 1765	95 070-170D-DL	95 070-170D-DR
NS 8,5	1165 - 1715	95 085-170D-DL	95 085-170D-DR
NS 10	1170 - 1720	95 100-170D-DL	95 100-170D-DR
NS 12,5	1145 - 1695	95 125-170D-DL	95 125-170D-DR



Grease separator *EasyClean* ground Direct NS 2 – 4 for underground installation



EN 1825 DIN 4040-100

Made of polyethylene

Installation

in frost-free depth

- Resistant when installed in the groundwater up to 500 mm
- A load distribution plate must be provided for class D

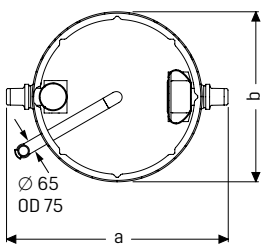
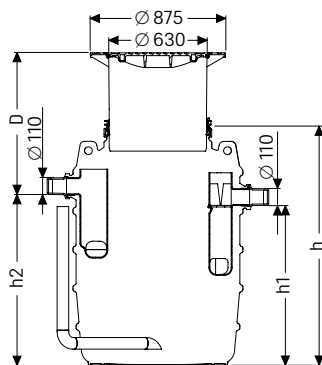
Consisting of:

Upper section made of polymer, continuous height and level adjustment, with cover class A / B, D (class D with *Lock & Lift* function) in accordance with EN 124 made of cast iron, sealed odour-tight, incl. lift-out key

Delivery: System completely assembled

➤ **Accessories:** Sampling chamber, extension section, *SonicControl* (NS 2 and NS 4) page 382 – 385, pumping stations see chapter "3"

➤ **Technical note:** page 379



NS	Ø (mm)	a (mm)	b (mm)	h ¹⁾ (mm)	h1 (mm)	h2 (mm)	Weight (kg)	Sludge trap (l)	Water and grease (l)	Grease storage (l)	Total (l)
2	110	1380	1106	1300	790	860	120	200	370	120	570
4	110	1380	1106	1550	1040	1110	130	400	370	160	770

¹⁾ Valued for Type 80 separators. For Type 120 h* = h + 250 mm.

Ø = Outer diameter D = Installation depth



Underground installation frost-free depth 800 mm

NS	Installation depth D in mm	Art. no.
Cover class A / B, direction of flow left		
NS 2	515 - 975	93 002.80B-DL
NS 4	515 - 975	93 004.80B-DL
Cover class A / B, direction of flow right		
NS 2	515 - 975	93 002.80B-DR
NS 4	515 - 975	93 004.80B-DR
Cover class D, direction of flow left		
NS 2	515 - 975	93 002.80D-DL
NS 4	515 - 975	93 004.80D-DL
Cover class D, direction of flow right		
NS 2	515 - 975	93 002.80D-DR
NS 4	515 - 975	93 004.80D-DR

Underground installation frost-free depth 1200 mm

NS	Installation depth D in mm	Art. no.
Cover class A / B, direction of flow left		
NS 2	765 - 1225	93 002.120B-DL
NS 4	765 - 1225	93 004.120B-DL
Cover class A / B, direction of flow right		
NS 2	765 - 1225	93 002.120B-DR
NS 4	765 - 1225	93 004.120B-DR
Cover class D, direction of flow left		
NS 2	765 - 1225	93 002.120D-DL
NS 4	765 - 1225	93 004.120D-DL
Cover class D, direction of flow right		
NS 2	765 - 1225	93 002.120D-DR
NS 4	765 - 1225	93 004.120D-DR



Grease separator *EasyClean* ground Standard NS 1 – 12,5 for underground installation

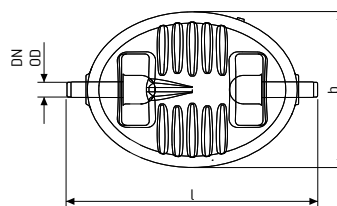
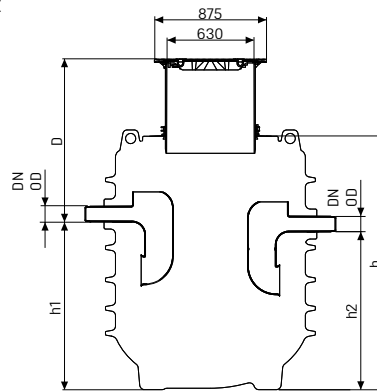


EN 1825 DIN 4040-100

The separator for greasy wastewater is suitable for installation in the ground and comes without metallic components in the tank. The collecting tank made of permanently resistant polymer (PE) is equipped with an integrated sludge trap and has a rounded base for fast and clean disposal. Access for cleaning and maintenance work is possible via a service access cover. A direct disposal pipe socket is available for manual disposal. A load distribution slab must be installed on site for load class D. The reinforcement drawings are part of the EBA and are available from KESSEL AG. The tank is groundwater resistant up to ground level (GL). 20 year polyethylene warranty.

➤ **Accessories:** Sampling chamber, extension section, *SonicControl* (NS 2 and NS 4) page 382 – 385, pumping stations see chapter "3"

➤ **Technical note:** page 379



NS	Ø (mm)	l (mm)	b (mm)	h (mm)	h1 (mm)	h2 (mm)	Weight (kg)	Sludge trap (l)	Water and grease (l)	Grease storage (l)	Total (l)
1	100	1700	1090	1515	870	800	215	100	550	40	650
2	100	1700	1090	1515	870	800	215	200	450	80	650
3	100	1700	1090	1820	1175	1105	230	300	615	120	915
4	100	1700	1090	1820	1175	1105	230	400	515	160	915
7	150	1870	1090	2375	1705	1635	305	700	930	280	1630
8,5	150	1870	1090	2375	1755	1685	305	850	850	340	1700
10	150	1870	1090	2795	2170	2100	345	1000	1100	400	2100
12,5	200	1870	1090	2795	2135	2065	350	1250	880	500	2130

Ø = Outer diameter

D = Installation depth

Underground installation frost-free depth 1200 mm

NS	Installation depth D in mm	Art. no.
Cover class B		
NS 1	690 – 1190	95 010-120B
NS 2	690 – 1190	95 020-120B
NS 3	690 – 1190	95 030-120B
NS 4	690 – 1190	95 040-120B
NS 7	715 – 1215	95 070-120B
NS 8,5	665 – 1165	95 085-120B
NS 10	670 – 1170	95 100-120B
NS 12,5	645 – 1145	95 125-120B

Cover class D, with *Lock & Lift* function

NS 1	900 – 1190	95 010-120D
NS 2	900 – 1190	95 020-120D
NS 3	900 – 1190	95 030-120D
NS 4	900 – 1190	95 040-120D
NS 7	925 – 1215	95 070-120D
NS 8,5	875 – 1165	95 085-120D
NS 10	880 – 1170	95 100-120D
NS 12,5	855 – 1145	95 125-120D

Underground installation frost-free depth 1700 mm

NS	Installation depth D in mm	Art. no.
Cover class B		
NS 1	1040 – 1740	95 010-170B
NS 2	1040 – 1740	95 020-170B
NS 3	1040 – 1740	95 030-170B
NS 4	1040 – 1740	95 040-170B
NS 7	1065 – 1765	95 070-170B
NS 8,5	1015 – 1715	95 085-170B
NS 10	1020 – 1720	95 100-170B
NS 12,5	995 – 1740	95 125-170B

Cover class D, with *Lock & Lift* function

NS 1	1190 – 1740	95 010-170D
NS 2	1190 – 1740	95 020-170D
NS 3	1190 – 1740	95 030-170D
NS 4	1190 – 1740	95 040-170D
NS 7	1215 – 1765	95 070-170D
NS 8,5	1165 – 1715	95 085-170D
NS 10	1170 – 1720	95 100-170D
NS 12,5	1145 – 1695	95 125-170D



Grease separator *EasyClean* ground Standard NS 1 – 4

for underground installation



EN 1825 DIN 4040-100

Made of polyethylene

Installation

- Resistant when installed in the groundwater up to 500 mm
- A load distribution plate must be provided for class D

Consisting of:

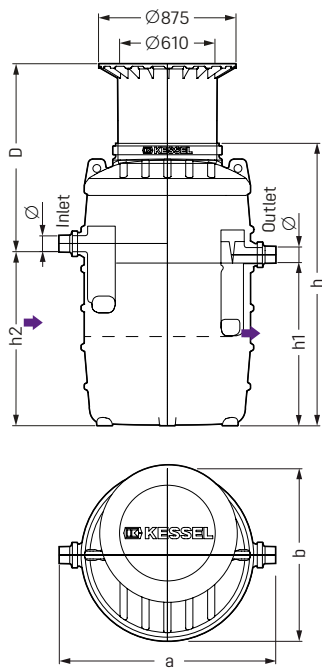
Upper section made of polymer, infinite height and level adjustment, with cover class A / B, D (class D with *Lock & Lift* function) in accordance with EN 124 made of cast iron, sealed odour-tight, incl. lift-out key

Delivery: System completely assembled

Note: Further nominal sizes on request

➤ **Accessories:** Sampling chamber, extension section, direct disposal, *SonicControl* (NS 2 and NS 4) page 382 – 385, pumping stations see chapter "3"

➤ **Technical note:** page 379



**Underground installation
frost-free depth 800 mm**

NS	Installation depth D in mm	Art. no.
Cover class A / B		
NS 1	515 - 975	93 001/80B
NS 2	515 - 975	93 002/80B
NS 4	515 - 975	93 004/80B

Cover class D, with <i>Lock & Lift</i> function		
NS	Installation depth D in mm	Art. no.
NS 1	515 - 975	93 001/80D
NS 2	515 - 975	93 002/80D
NS 4	515 - 975	93 004/80D

**Underground installation
frost-free depth 1200 mm**

NS	Installation depth D in mm	Art. no.
Cover class A / B		
NS 1	765 - 1225	93 001/120B
NS 2	765 - 1225	93 002/120B
NS 4	765 - 1225	93 004/120B

Cover class D, with <i>Lock & Lift</i> function		
NS	Installation depth D in mm	Art. no.
NS 1	765 - 1225	93 001/120D
NS 2	765 - 1225	93 002/120D
NS 4	765 - 1225	93 004/120D

NS	Ø (mm)	a (mm)	b (mm)	h ¹⁾ (mm)	h1 (mm)	h2 (mm)	Weight (kg)	Sludge trap (l)	Water and grease (l)	Grease storage (l)	Total (l)
1	110	1380	1106	1050	540	610	111	140	230	70	370
2	110	1380	1106	1300	790	860	120	200	370	120	570
4	110	1380	1106	1550	1040	1110	130	400	370	160	770

¹⁾ Specifications apply for type 80. For type 120, h* = h + 250 mm.

Ø = Outer diameter D = Installation depth



Grease separator *EasyClean* ground Standard NS 7 – 35 for underground installation



EN 1825 DIN 4040-100

Made of polyethylene

Installation

in frost-free depth

- Installation is possible with groundwater up to the upper edge of the tank (UET)
- A load distribution plate must be provided for class D
- Class D = 700 mm ≤ DEC ≤ 1500 mm
Class A/ B = 700 mm ≤ DEC ≤ 1800 mm
- Minimum installation depth achieved by sawing the upper section as required

Consisting of:

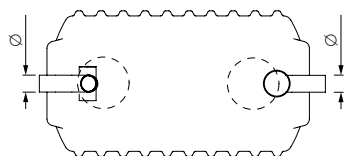
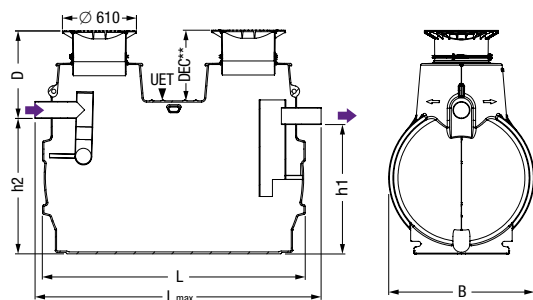
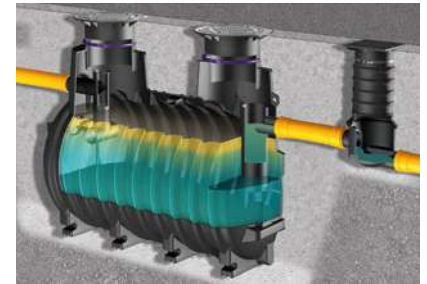
Upper section made of polymer, height and level adjustment, with cover class A/B, D (class D with *Lock & Lift* function) in accordance with EN 124, made of cast iron (can be driven over by cars and trucks), sealed odour-tight, incl. lift-out key

Delivery: System completely assembled

Note: Further nominal sizes on request

➤ **Accessories:** Sampling chamber, extension section, direct disposal, *SonicControl* page 382 – 385, pumping stations see chapter "3"

➤ **Technical note:** page 379



**DEC = Depth of earth coverage

NS	Ø (mm)	L (mm)	B (mm)	h1 (mm)	h2 (mm)	Sludge trap (l)	Water and grease (l)	Grease storage (l)	Total (l)	D-DEC	Lmax
7	160	2390	1200	1030	1100	700	1100	280	1800	220	2540
10	160	2910	1200	1030	1100	1000	1600	400	2600	220	3060
15	200	2590	1760	1550	1620	1500	2800	600	4300	185	2780
20	200	3110	1760	1550	1620	2000	3800	800	5800	185	3300
25	200	3470	2010	1550	1650	2500	5300	2000	7800	480	3760
30	250	3470	2010	1550	1650	3000	4800	2000	7800	480	3760
35	250	3470	2010	1700	1800	3500	4800	2000	8300	330	3760

Ø = Outer diameter D = Installation depth

NS	Installation depth D in mm	Weight in kg	Art. no.
Cover class A / B			
NS 7	705 - 1200	315	93 007/120B
NS 10	705 - 1200	340	93 010/120B
NS 15	730 - 1225	435	93 015/120B
NS 20	730 - 1225	490	93 020/120B
NS 25	765 - 1260	665	93 925/120B
NS 30	765 - 1260	665	93 930/120B
NS 35	615 - 1110	665	93 935/120B

NS	Installation depth D in mm	Weight in kg	Art. no.
Cover class D, with Lock & Lift function			
NS 7	705 - 1200	450	93 007/120D
NS 10	705 - 1200	480	93 010/120D
NS 15	730 - 1225	630	93 015/120D
NS 20	730 - 1225	670	93 020/120D
NS 25	765 - 1260	765	93 925/120D
NS 30	765 - 1260	765	93 930/120D
NS 35	615 - 1110	765	93 935/120D

Extended version for deeper installation with extension section Ø 800 mm

NS	Installation depth D in mm	Weight in kg	Art. no.
Cover class A / B			
NS 7	1085 - 1765	345	93 007/170B
NS 10	1085 - 1765	370	93 010/170B
NS 15	1095 - 1780	465	93 015/170B
NS 20	1095 - 1780	520	93 020/170B
NS 25	1120 - 1800	695	93 925/170B
NS 30	1120 - 1800	695	93 930/170B
NS 35	970 - 1650	695	93 935/170B

NS	Installation depth D in mm	Weight in kg	Art. no.
Cover class D, with Lock & Lift function			
NS 7	1085 - 1765	480	93 007/170D
NS 10	1085 - 1765	510	93 010/170D
NS 15	1095 - 1780	660	93 015/170D
NS 20	1095 - 1780	700	93 020/170D
NS 25	1120 - 1800	795	93 925/170D
NS 30	1120 - 1800	795	93 930/170D
NS 35	970 - 1650	795	93 935/170D



Grease separator *EasyClean Modular Standard NS 1 – 4*

for underground installation in frost-free depth, with separate sludge trap



DIN 4040-100

Made of polyethylene

Installation

in frost-free depth

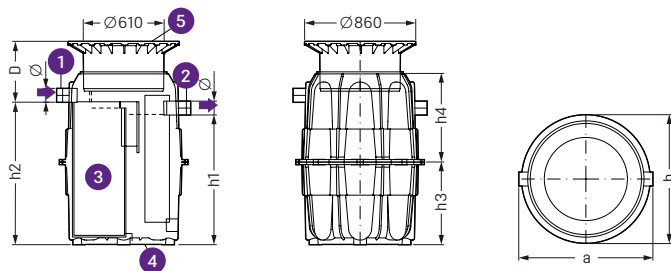
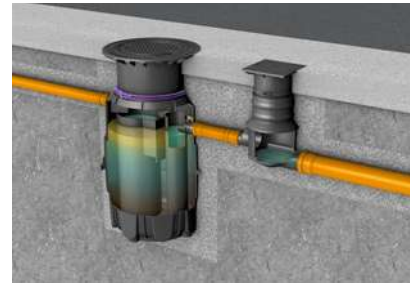
- Resistant when installed in the groundwater up to 500 mm
- A load distribution plate must be provided for class D

Consisting of:

Upper section made of polymer, height and level adjustment, with cover class A / B, D (class D with *Lock & Lift* function) in accordance with EN 124, made of cast iron (can be driven over by cars and trucks), sealed odour-tight, incl. lift-out key

Delivery: System completely assembled

➤ **Accessories:** Sampling chamber, extension section, direct disposal, *SonicControl* (NS 2 and NS 4) page 382 – 385, lifting stations see chapter "3"



- 1 Inlet
- 2 Outlet
- 3 Sludge trap
- 4 Separation chamber
- 5 Upper section with cover class A / B, D

NS	Installation depth D in mm	Art. no.
<i>Cover class A / B</i>		
NS 1	295 - 480	98 201/00B
NS 2	295 - 480	98 202/00B
NS 4	295 - 480	98 204/00B
<i>Cover class D, with Lock & Lift function</i>		
NS 1	295 - 480	98 201/00D
NS 2	295 - 480	98 202/00D
NS 4	295 - 480	98 204/00D

Technical note
for pages 372 – 379

Weather-related influences or cooling of the tanks during the installation phase (caused by filling with cold water) can lead to deviations in dimensions from the catalogue specifications in the case of cisterns and separators installed in the ground.

NS	Ø (mm)	a (mm)	b (mm)	h1 (mm)	h2 (mm)	h3 (mm)	h4 (mm)	Weight (kg)	Sludge trap (l)	Water and grease (l)	Grease storage (l)	Total (l)
1	110	1055	1020	1020	1120	650	720	140	105	415	40	420
2	110	1355	1300	1136	1236	750	750	190	200	945	80	1145
4*	110	2635	1300	1136	1236	750	750	330	600	1150	160	1750

* NS 4 separator consist of two chambers

Ø = Outer diameter D = Installation depth



Grease separators

EasyClean ground Multi

Grease separator and pumping station in one chamber.

The convenient solution with just one chamber! The *EasyClean ground Multi* allows for the installation of the grease separator, sampling chamber and lifting station in a single chamber. This means that the entire system can be designed and installed as a whole. This procedure not only saves time and effort but also costs.

The *EasyClean ground Multi* grease separator is available for load classes A/B and D as well as in nominal sizes NS 4, NS 7 and NS 10. The *SonicControl* layer thickness measuring device, with which the disposal cycles of the separator can be monitored and optimised, is available as an optional accessory. In addition, other installation depths and nominal sizes for special requirements and installation situations are also available on request – all you need to do is contact us!



1 Grease separator 2 Sampling chamber 3 Lifting station

Two variants – one goal

With the standard version of the *EasyClean ground Multi* the grease separator is emptied and cleaned manually. The odour-tight covers must be opened for emptying and cleaning. Disposal with the *EasyClean ground Multi Direct* is uncomplicated: With an extended disposal pipe on site, the disposal vehicle's connection can be made via a separate chamber or a wall cabinet. That means no opening of the tank, no unpleasant odours.



Grease separator *EasyClean* ground *Multi* Standard and Direct NS 4 – 10

for underground installation



Material: polymer

Einbau: for frost-free depth

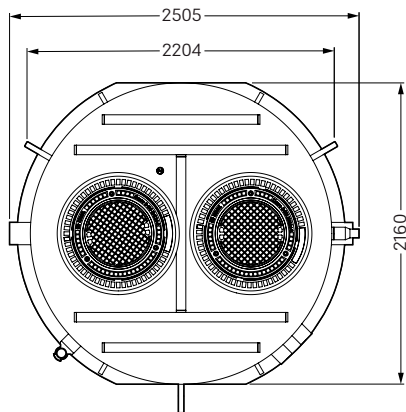
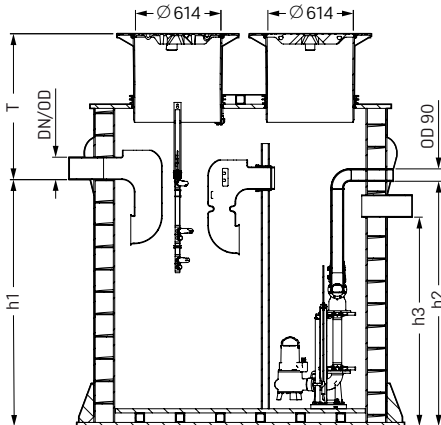
- Installation up to groundwater GL
- a load distribution slab must be provided for load class D
- Class B = 550 mm ≤ DSC ≤ 1200 mm
Class D = 720 mm ≤ DSC ≤ 1200 mm
- minimum installation depth achievable by cutting the upper section to the required length

Version includes: Grease separator in spirally wound pipe, with integrated sampling, pump station in wet installation with GTK 1300-S1 pumps (refer to page 145 for data), telescopic height-adjustable upper section made of plastic, cover class A/B, D (class D with Lock & Lift function) to EN 124 made of GG (can be driven over by cars and trucks), closed odour-tight

Delivery: Separator completely assembled, pumps separate

Note: Further nominal sizes and installation depths on request

➤ **Accessories:** *SonicControl* grease layer thickness measuring device



EasyClean ground *Multi* Standard

NS	Installation depth D in mm	Art. no.	PG
----	----------------------------	----------	----

Installation in the ground, frost-free depth 800 mm

Cover load class A/B

NS 4	515 - 985	96 004.80B	60
NS 7	515 - 985	96 007.80B	60
NS 10	515 - 985	96 010.80B	60

Cover load class D, mit *Lock & Lift*-Funktion

NS 4	720 - 985	96 004.80D	60
NS 7	720 - 985	96 007.80D	60
NS 10	720 - 985	96 010.80D	60

Installation in the ground, frost-free depth 1200 mm

Cover load class A/B

NS 4	755 - 1225	96 004.120B	60
NS 7	755 - 1225	96 007.120B	60
NS 10	755 - 1225	96 010.120B	60

Cover load class D, mit *Lock & Lift*-Funktion

NS 4	960 - 1225	96 004.120D	60
NS 7	960 - 1225	96 007.120D	60
NS 10	960 - 1225	96 010.120D	60

EasyClean ground *Multi* Direct

NS	Installation depth D in mm	Art. no.	PG
----	----------------------------	----------	----

Installation in the ground, frost-free depth 800 mm

Cover load class A/B, Flow direction left

NS 4	515 - 985	96 004.80B-DL	60
NS 7	515 - 985	96 007.80B-DL	60
NS 10	515 - 985	96 010.80B-DL	60

Cover load class A/B, Flow direction right

NS 4	515 - 985	96 004.80B-DR	60
NS 7	515 - 985	96 007.80B-DR	60
NS 10	515 - 985	96 010.80B-DR	60

Cover load class D, Flow direction left

NS 4	720 - 985	96 004.80D-DL	60
NS 7	720 - 985	96 007.80D-DL	60
NS 10	720 - 985	96 010.80D-DL	60

Cover load class D, Flow direction right

NS 4	720 - 985	96 004.80D-DR	60
NS 7	720 - 985	96 007.80D-DR	60
NS 10	720 - 985	96 010.80D-DR	60

Installation in the ground, frost-free depth 1200 mm

Cover load class A/B, Flow direction left

NS 4	755 - 1225	96 004.120B-DL	60
NS 7	755 - 1225	96 007.120B-DL	60
NS 10	755 - 1225	96 010.120B-DL	60

Cover load class A/B, Flow direction right

NS 4	755 - 1225	96 004.120B-DR	60
NS 7	755 - 1225	96 007.120B-DR	60
NS 10	755 - 1225	96 010.120B-DR	60

Cover load class D, Flow direction left

NS 4	960 - 1225	96 004.120D-DL	60
NS 7	960 - 1225	96 007.120D-DL	60
NS 10	960 - 1225	96 010.120D-DL	60

Cover load class D, Flow direction right

NS 4	960 - 1225	96 004.120D-DR	60
NS 7	960 - 1225	96 007.120D-DR	60
NS 10	960 - 1225	96 010.120D-DR	60

Art.-Nr.	Einbautiefe T	h1	h2	h3
96 004.80B	515 - 985	1125	830	1115
96 007.80B	515 - 985	1600	1330	1590
96 010.80B	515 - 985	1770	1500	1760
96 004.80D	720 - 985	1125	830	1115
96 007.80D	720 - 985	1600	1330	1590
96 010.80D	720 - 985	1770	1500	1760
96 004.120B	755 - 1225	1125	830	1115
96 007.120B	755 - 1225	1600	1330	1590
96 010.120B	755 - 1225	1770	1500	1760
96 004.120D	960 - 1225	1125	830	1115
96 007.120D	960 - 1225	1600	1330	1590
96 010.120D	960 - 1225	1770	1500	1760

Values for Direct versions are identical

Accessories

Grease separators for underground installation

Direct disposal, without disposal chamber

Disposal connection right or left

Compatibility: Installed in the ground with direct disposal connection; for grease separators for underground installation according to EN 1825
Inclusive: Flange connection Ø 65, PN 10 (welded collar and loose flange) for the suction pipe on site, with Storz-B coupling R 2 1/2" for disposal vehicle, for nominal sizes NS 1 - NS 35
Delivery: Installed suction device for the joint disposal from sludge trap and separating chamber, tank and direct connection completely assembled, disposal pipe and Storz-B connection on site.
Note: Further installation depths, sizes and connections on request



Disposal connection	Art. no.
right	917 419.00
left	917 419.50

Disposal chamber Ø 400

Disposal chamber

Compatibility: For separator systems Auto Mix & Pump, Auto Mix and Mix for installation in the ground
Material: Polyethylene, watertight
Installation depth: 710 - 1080 mm
Inclusive: With telescopic, height-adjustable upper section made of polymer with clamping ring, cover class A/B, D in accordance with EN 124 made of cast iron, sealed odour-tight, incl. lift-out key, with Storz-B coupling R 2 1/2" for disposal vehicle. Pressure pipe connection between separator and disposal chamber provided on-site.



Cover	Art. no.
Class A/B	917 422B
Class D	917 422D

Joint and connection set

Joint and connection set

Material: Polyethylene
Compatibility: For connection of the grease separator (NS 1 - NS 20) to the technical chamber for the versions grease separators Auto Mix & Pump, Auto Mix and Mix in ground installation
Inclusive: Storz-B coupling, pipe clamps



Art. no.
917 421

Direct disposal, including disposal chamber Ø 400

Disposal connection right or left

Compatibility: Installed in the ground with direct disposal connection for nominal sizes NS 1 - NS 35; for grease separators for underground installation according to EN 1825
Installation depth: 630 - 980 mm
Inclusive: Flange connection Ø 65, PN 10 (welded collar and loose flange) for the suction pipe on site, with Storz-B coupling R 2 1/2" for disposal vehicle, with chamber system Ø = 400 mm, incl. cover class A/B/D, sealed
Delivery: Installed suction device for the joint disposal from sludge trap and separating chamber, tank and direct connection completely assembled, disposal pipe on site.
Note: Further installation depths, sizes and connections on request



Disposal connection	Art. no.
right	917 420.00
left	917 420.50

Direct disposal

Disposal chamber Ø 400

Accessories

Grease separators for underground installation

SonicControl level sensing system

Art. no.

Level sensing system

Compatibility: For grease separators for underground installation

Inclusive: Ultra sonic sensor for electronic measurement, display and control of the grease layer thickness and the water temperature; power connection, battery back up, connection for remote speaker; installation set with easy assembly and maintenance; control unit with optical and audible alarm with potential free contact; electronic log book with 12 month capacity. Data transfer by telemetry.

Voltage: 230 V ~ 50 Hz

Protection type: IP 54

Plug: Schuko 1.5 m

Cable length: 10 m (extendable on-site to 60 meters)

917 821



Cable access conduit

Art. no.

Cable access conduit

Compatibility: For grease separators for underground installation according to EN 1825 and DIN 4040; for watertight connection of *SonicControl* cable into separator chamber

Inclusive: Gasket, cable connection, extension, sensor bracket

Note: Conduit pipe with chase wire should be planned; requires 50 mm OD conduit pipe (PE-HD) -sourced on-site. Max. distance 30 m

917 823



Cable extension set for *SonicControl FA*

Art. no.

10 m extension

917 871

20 m extension

917 872

30 m extension

917 873

extendable on-site to 60 meters



Remote control

Art. no.

Remote control

Compatibility: Fits KESSEL separation systems for free standing installation according to EN 1825, for connection to an isolated ground socket

Version: Model Auto Mix & Pump and Auto Mix in accordance with EN 1825

Cable length: 15 m

916 601



Accessories

Grease separators for underground installation

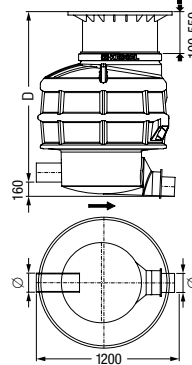
Sampling chamber Ø 1000

Cover class A/B

Compatibility: For separation systems NS 1 – NS 20 and special models; for underground installation
Installation depth (D): 1145 – 1585 mm
 (Other installation depths available on request)
Drop height: 160 mm

Cover class D, with Lock & Lift function

Inclusive: Inlet and outlet Ø ... for synthetic material pipes in: PE-HD (according to EN 12666-1); PVC-KG (according to EN 1401-1); PP or AS.
 With integrated access steps, with vertically height-adjustable upper section made of polymer, with cover class A / B, D according to EN 124 in cast iron sealed odour-tight, incl. removal mechanism.



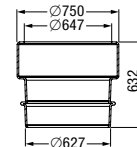
Outer dia-meter Ø (mm)	Suitable for separator	Art. no.
Ø 110	NS 1, NS 2, NS 4	915 10 10B
Ø 160	NS 7, NS 10	915 10 15B
Ø 200	NS 15, NS 20*	915 10 20B
Ø 110	NS 1, NS 2, NS 4	915 10 10D
Ø 160	NS 7, NS 10	915 10 15D
Ø 200	NS 15, NS 20*	915 10 20D

*Suitable for individual solutions

Extension section

Extension section

Compatibility: For underground grease separators with 600 mm access cover
Height increase: 500 mm



Art. no.

917 460

Sampling chamber Ø 400

Cover class A

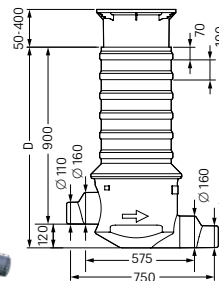
Compatibility: For connection to outlet pipe of separator for underground installation

Cover class B

Installation depth (D): 400 – 1300 mm
 (minimum installation depth can be achieved by cutting off)

Cover class D

Drop height: 120 mm (160 mm on request)
Inclusive: Telescopic upper section with clamping ring, cover class A / B / D, sealed odour-tight
Extension: 600 mm
 with extension section Art. no. 915 402



In-/Outlet	Art. no.
Ø 110/160	915 880A
Ø 110/160	915 880B
Ø 110/160	915 880D

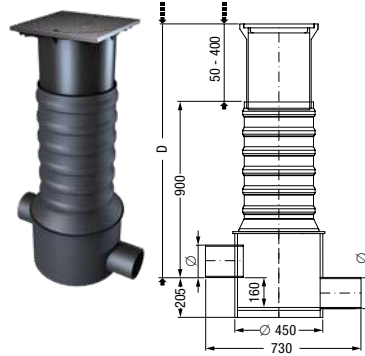
Accessories

Grease separators for underground installation

Sampling chamber Ø 450

Cover class A

Compatibility: For connection to outlet pipe of separators for underground installation
Installation depth (D): 950 - 1300 mm
Drop height: 160 mm
Inclusive: Telescopic upper section with clamping ring, cover class A/B/D, sealed odour-tight
Extension: 600 mm with extension section Art. no. 915 402



In-/Outlet	Art. no.
Ø 110	915 881A
Ø 160	915 882A
Ø 200	915 883A
Ø 260	915 884A
Ø 110	915 881B
Ø 160	915 882B
Ø 200	915 883B
Ø 260	915 884B
Ø 110	915 881D
Ø 160	915 882D
Ø 200	915 883D
Ø 260	915 884D

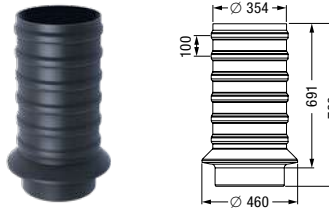
Cover class B

Cover class D

Extension section

Extension section

Compatibility: For sampling chamber Ø 400 and Ø 450
Extension height: max. 600 mm (can be shortened on-site)
Check maintenance accessibility!

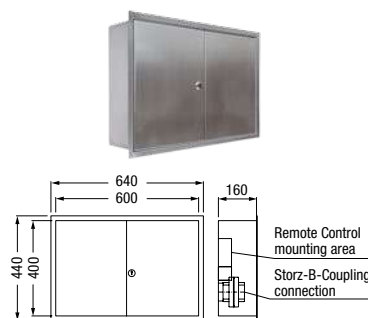


Art. no.
915 402

Access panel

Recessed wall installation

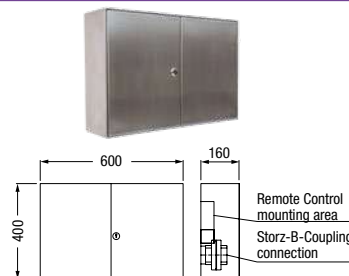
Material: Stainless steel
Compatibility: For Storz-B disposal pipe hook up connection and remote control connection for use with fully automated grease separators. Remote control not included
Inclusive: 2 doors, lockable
Note: Special dimensions on request



Width × Height × Depth in mm	Art. no.
640 × 440 × 160	917 414

Wall installation

Material: Stainless steel
Compatibility: For Storz-B disposal pipe hook up connection and remote control connection for use with fully automated grease separators. Remote control not included
Inclusive: 2 doors, lockable
Note: Special dimensions on request



600 × 400 × 160	917 413
-----------------	---------

Secondary wastewater treatment

Bifena

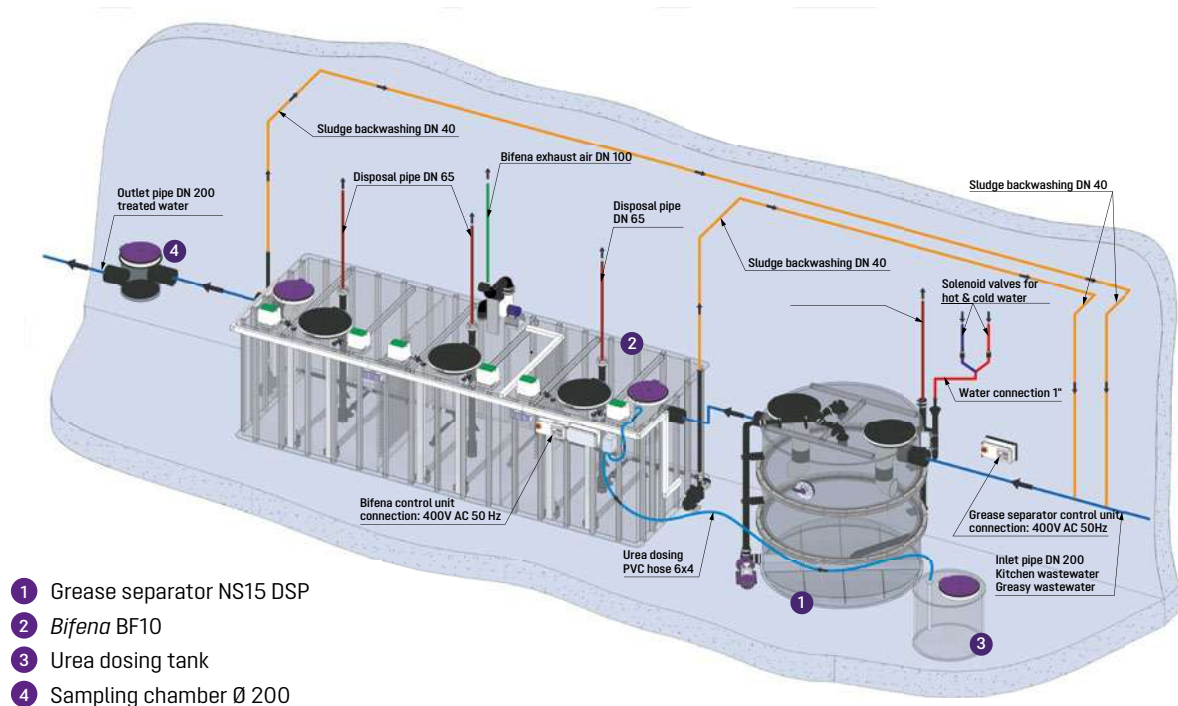
When a grease separator alone is not enough: after treatment, wastewater draining out of a properly sized and certified EN 1825 grease separator normally has a residual value of lipophilic substances of approx. 300 mg/l. If the municipalities require a limit value of below 300 mg/l, biological grease treatment with a Bifena unit is needed. It removes residual grease from the wastewater with the help of bacteria.

Bifena units are available for free-standing or underground installation. The individual dimensioning is based on a wastewater sample analysis to determine what additional treatment measures need to be taken to meet local wastewater limits. Contact us – we will be happy to advise you and develop an individual solution for your specific requirements.

On the other hand, it may be necessary for chemical substances to be added. In this case a dosing station is advisable, with which the correct quantity of chemicals can be added to the separator. The unit consists of a mixing and a dosing station and can be installed near the separator.

Individual solutions

info@kessel.com



Bifena units for biological grease treatment

for free-standing installation / for underground installation



Material: Polymer

Version:

- Bifena modules for connection after grease separators NS 2 / 4 / 7 / 10 / 15 and 20

Bifena BF 2 and Bifena BF 4

Delivery: Completely assembled system or on-site welding

Bifena with larger dimensions

Delivery: on-site welding

Dimensioning: Following a wastewater sample analysis to determine what additional treatment measures need to be taken to meet local wastewater limits

Accessories: Lifting stations, sampling devices, etc. from the KESSEL range are matched to the respective project-dependent system

Customised solution: e-Mail: info@kessel.com



Unit for chemical treatment

for free-standing installation



Material: Polymer

Version:

- Dosing station for combination with grease separators in nominal sizes NS 2 – NS 30

Delivery: Mixing and dosing station for preliminary or secondary treatment

Accessories: Lifting stations, sampling devices, etc.

Customised solution: e-Mail: info@kessel.com



5.2 Coalescence / Oil / Fuel Separators

Treatment of oil / fuel contaminated
wastewater





Coalescence and oil / fuel separators

EasyOil free

The exposed installation for wastewater with light liquids.

Bodies of water and sewer systems must be reliably protected from contamination with mineral oil. However, a coalescence separator cannot always be installed in the ground. The reason for this can be an inlet that is too deep below the ground level or a high groundwater pressure, which prevents the installation of a cistern in the ground. This can be the case, for example, in underground car parks or in the basement of multi-storey car parks.

The *EasyOil free* was developed for these specific requirements: the space-saving alternative for exposed installation. This model is available in nominal sizes 3 and 6.



- 1 Coalescence separator
- 2 Lifting station
- 3 Sampling chamber

Space-saving and modular design

As the *EasyOil free* needs only a small installation area, it is ideally suitable for many rooms. Its modular design is an advantage: Its dismantled individual components can be taken to the place of installation.

SonicControl

The automatic layer thickness measuring device *SonicControl* with ultrasonic sensor takes over the precise monitoring and reporting of the oil layer thickness in coalescence and oil/fuel separators. Operators can therefore monitor the actual volumes of oil and fuel inside the separator to determine the precise disposal date.

Coalescence separator *EasyOil* free NS 3 and NS 6, class I, Ø 1000

for free-standing installation according to EN 858



EN 858

Installation

For free standing installation

Consisting of:

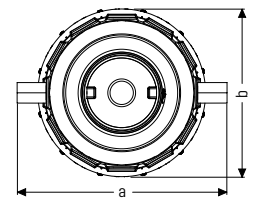
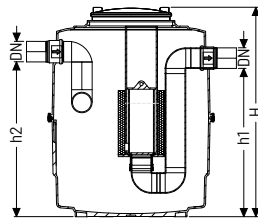
Integrated sludge trap and self-actuated closure lock, calibrated for light liquids with densities between 0.85 to 0.95 g/cm³. With removable coalescence filter insert. Completely water tight to top of cover, resistant against aggressive wastewaters, certified structural test. Corrosion free HDPE

Inlet and outlet Ø for connection pipes:

PE-HD (according to EN 12666-1),

PVC pipe (according to EN 1401-1), PP or AS.

Delivery: Completely assembled



NS	Art. no.
NS 3	99 703.10F
NS 6	99 706.06F

NS	DN	Outer diameter Ø (mm)	Cover Ø (mm)	a (mm)	b (mm)	h1 (mm)	h2 (mm)	H (mm)	Weight empty (kg)	Sludge trap capacity (l)	Oil storage capacity (l)	Total (l)
3	100	110	630	1550	1322	1055	1105	1615	210	300	150	850
6	150	160	630	1580	1322	1155	1205	1615	220	600	180	880

Ø = Outer diameter

Coalescence separator *EasyOil* free NS 1,5-3 class I

for free-standing installation



Material: PE

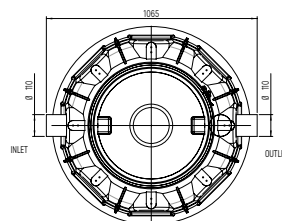
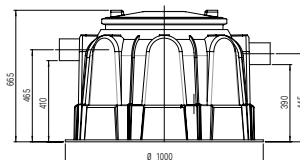
Consisting of: Sludge trap (in selected variants), self-actuated closure lock, inlet and outlet DN100

Optionally: Backwater valve according to DIN 13564 (on request)

Bypass (on request)

Controller with level sensors and the possibility of connection to the BMS (on request)

Note: The automatic measuring device *SonicControl* cannot be installed here



NS	Art. no.
Without a sludge trap	
1,5	99815
3	99830
With a sludge trap	
1,5	99815S
3	99830S

NS	Outer diameter Ø (mm)	Total volume (l)	Sludge trap capacity (l)	L (mm)	B (mm)	H (mm)	h1 (mm)	h2 (mm)	Weight (kg)	Oil storage capacity (l)	Excess level (mm)
Without a sludge trap											
1,5	110	212	-	1065	1000	665	390	410	41	38	72
3	110	415	-	1360	1300	750	390	410	69	78	72
With a sludge trap											
1,5	110	260	75	1065	1000	700	475	495	43	38	72
3	110	590	300	1360	1300	855	545	565	71	78	72

Coalescence and oil / fuel separators

EasyOil ground

For the treatment of oil / fuel contaminated wastewater

EasyOil separators are available in Class I high efficiency coalescence separators for use in treating wastewater from petrol stations, car washes, vehicle repair garages or any source with oil/fuel contaminated wastewater.

The *EasyOil* separators are available for above-ground and under-ground installation.



- 1** Coalescence separator
- 2** Height adjustable upper section
- 3** Sampling chamber

Emergency float switch

EasyOil is equipped with a self-actuated closure lock. This emergency system prevents the leakage of light liquids into the sewer pipe.

Vertically adjustable upper section

Underground models are equipped with vertically adjustable upper section which are also tiltable up to 5° – for optimum adaptation to the ground level and to compensate for ground settling.

Polymer

EasyOil is the first series of polymer coalescence and oil/fuel separator systems on the German market with national technical approval. The polyethylene material used is resistant to bioethanol (E10) and biodiesel – and therefore particularly durable. In addition to the statutory provision, we provide a 20-year warranty with regard to the leak tightness and structural safety of tanks and upper sections.

SonicControl

The automatic layer thickness measuring device *SonicControl* with ultrasonic sensor takes over the precise monitoring and reporting of the oil layer thickness in coalescence and oil/fuel separators. Operators can therefore monitor the actual volumes of oil and fuel inside the separator to determine the precise disposal date.

Coalescence separator *EasyOil* ground NS 3 – 6, class I, Ø 1000

for underground installation



Based on EN 858

Made of polyethylene

Installation

For underground installation, installation depth (D) from ... mm

- Not for installation in high groundwater areas!

Consisting of:

Integrated sludge trap and self-actuated closure lock, calibrated for light liquid with densities between 0.85 to 0.95 g/cm³.

With removable coalescence filter insert. Completely water tight to top of cover, resistant against aggressive wastewaters. Vertically adjustable polymer upper section, tiltable to 5°, cast iron manhole cover according to EN 124, load class D, with removal key, certified structural test.

Inlet and outlet Ø for synthetic material pipes in:

PE-HD (according to EN 12666-1); PVC pipe (according to EN 1401-1); PP or AS.

Delivery: Completely assembled

Note: Choose separator size and article number from table below.

Contact KESSEL for separator sizing support if required.

➤ **Accessories:** *SonicControl*, e.g. see page 397 – 399



Illustration shows Art. no. 99 703.10B

Illustration shows Art. no. 99 706.10B

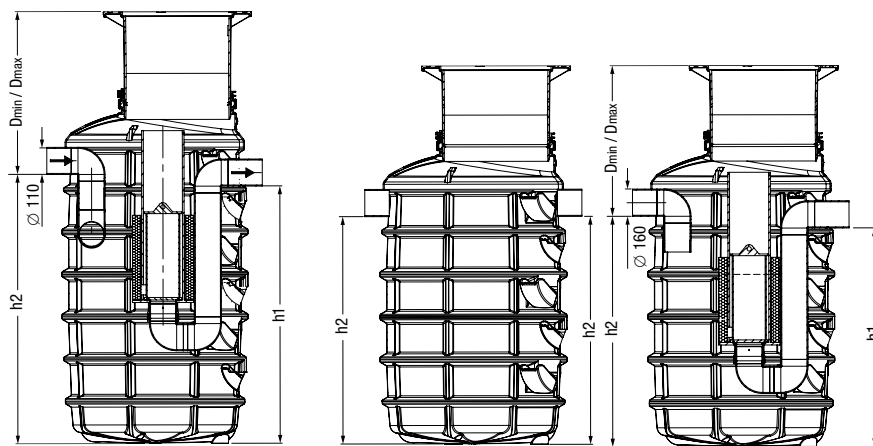


Illustration shows Art. no. 99 703.04B

Illustration shows Art. no. 99 706.18B (Twin-chamber system)

NS Art. no.

Cover class A / B

NS 6	99 706.02B
NS 6	99 706.06B
NS 3	99 703.04B
NS 6 ¹⁾	99 706.10B
NS 3	99 703.10B
NS 6 ¹⁾	99 706.18B

Cover class D

NS 6	99 706.02D
NS 6	99 706.06D
NS 3	99 703.04D
NS 6 ¹⁾	99 706.10D
NS 3	99 703.10D
NS 6 ¹⁾	99 706.18D

NS	Ø*	Installation depth D (min/max) (mm)	Sludge disposal volume (l)	Weight (kg)	h2 (Inlet bottom) (mm)	h1 (Outlet bottom) (mm)	Oil storage capacity (l)	Sludge trap capacity (l)	Art. no.
6	160	560 - 1090	200	175	1090	1020	200	400	99 706.02B
6	160	560 - 1090	650	175	1590	1520	200	1300	99 706.06B
3	110	545 - 995	400	175	1105	1055	200	800	99 703.04B
6 ¹⁾	160	560 - 1090	850	305	1090	1020	200	1700	99 706.10B
3	110	545 - 995	850	190	1605	1555	200	1700	99 703.10B
6 ¹⁾	160	560 - 1090	1900	320	1590	1520	200	3800	99 706.18B
6	160	560 - 1090	200	205	1090	1020	200	400	99 706.02D
6	160	560 - 1090	650	220	1590	1520	200	1300	99 706.06D
3	110	545 - 995	400	205	1105	1055	200	800	99 703.04D
6 ¹⁾	160	560 - 1090	850	338	1090	1020	200	1700	99 706.10D
3	110	545 - 995	850	220	1605	1555	200	1700	99 703.10D
6 ¹⁾	160	560 - 1090	1900	353	1590	1520	200	3800	99 706.18D

*Ø = Inlet and outlet outer diameter (mm) ¹⁾ Twin-chamber system

Coalescence separator *EasyOil* ground NS 3 – 15, class I

for underground installation with DIBt-certification



DIN 1999-100 DIN 1999-101 Z-83.8-54

Made of polyethylene

Installation

- Installation is possible with groundwater up to the upper edge of the tank (UET)
- A load distribution plate must be planned for class D
- Class D = 700 mm ≤ DEC ≤ 1500 mm
Class A / B = 700 mm ≤ DEC ≤ 1800 mm

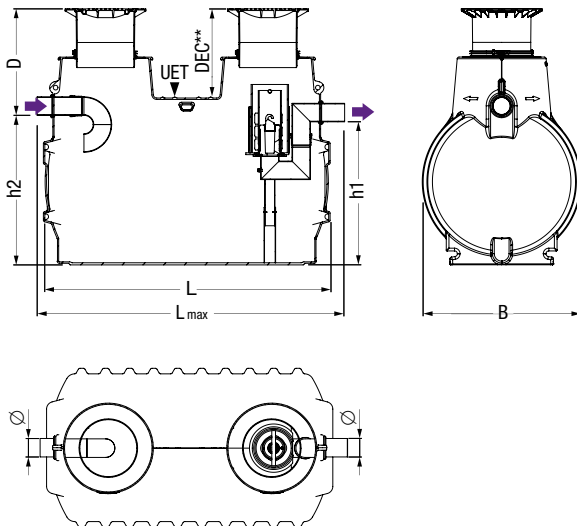
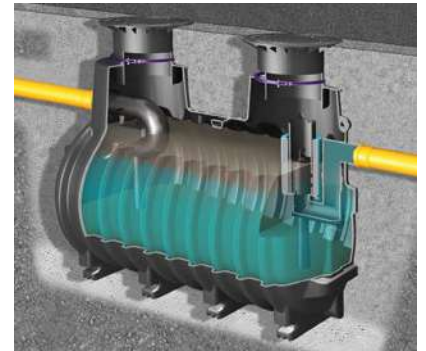
Consisting of:

Removable coalescence filter. Upper sections made of polymer, continuous height and level adjustment, tiltable to 5°, with covers class A / B, D according to EN 124 in cast iron (can be driven over by cars and trucks), incl. lift-out key. Inlet and outlet Ø ... for synthetic material pipes in: PE-HD (according to EN 12666-1); PVC pipe (according to EN 1401-1); PP or AS.

Note:

- Suitable for filling stations with high-performance filling pumps, E10 and biodiesel fuels
- Choose separator size and article number from table below.
Contact KESSEL for separator sizing support if required

➤ **Accessories:** Sampling chamber for underground installation, extension section for deep installation, alarm units for when the maximum oil level is reached and there is a back-up of water (required according to EN 858 Part 1), oil and sludge suction system, *SonicControl* page 397 – 399, pumping stations see chapter "3"



NS	Installation depth D (min/max) in mm	Art. no.
Cover class A/B		
NS 3	710 - 1170	99 503.10B EX
NS 6	735 - 1195	99 706.30B EX
NS 6	735 - 1195	99 706.80B EX
NS 10	710 - 1170	99 710.15B EX
NS 10	735 - 1195	99 710.30B EX
NS 10	735 - 1195	99 710.80B EX
NS 15	735 - 1195	99 715.80B EX
Cover class D		
NS 3	710 - 1170	99 503.10D EX
NS 6	735 - 1195	99 706.30D EX
NS 6	735 - 1195	99 706.80D EX
NS 10	710 - 1170	99 710.15D EX
NS 10	735 - 1195	99 710.30D EX
NS 10	735 - 1195	99 710.80D EX
NS 15	735 - 1195	99 715.80D EX

Technical note

Weather-related influences or cooling of the tanks during the installation phase (caused by filling with cold water) can lead to deviations in dimensions from the catalogue specifications in the case of cisterns and separators installed in the ground.

NS	Ø* (mm)	Sludge trap capacity (l)	L (mm)	B (mm)	h1 (mm)	h2 (mm)	Oil storage capacity (l)	Excess level	Weight (kg)	Total volume (l)	D-DEC	Lmax
3	160	1000	2390	1200	1070	1100	215	90	395	1800	155	2642
6	200	2500 ¹⁾	2590	1760	1600	1630	380	120	535	4300	180	2940
6	200	5000	3110	1760	1600	1630	470	130	610	5800	180	3460
10	160	1500	2910	1200	1070	1100	267	100	440	2600	155	3162
10	200	2500 ¹⁾	2590	1760	1600	1630	380	120	535	4300	180	2940
10	200	5000	3110	1760	1600	1630	470	130	610	5800	180	3460
15	200	5000	3110	1760	1600	1630	470	130	610	5800	180	3460

* Ø = Inlet and outlet outer diameter (mm)

¹⁾ Comparable sludge trap total volume in accordance with the dimensioning according to EN 858.

Oil-/fuel separator *EasyOil* ground NS 3 – 20, class II

for underground installation with DIBt-certification



DIN 1999-100 DIN 1999-101 Z-83.8-55

Made of polyethylene

Installation

- Installation is possible with groundwater up to the upper edge of the tank (UET)
- A load distribution plate must be planned for class D
- Class D = 700 mm ≤ DEC ≤ 1500 mm
Class A / B = 700 mm ≤ DEC ≤ 1800 mm

Consisting of:

Upper sections made of polymer, continuous height and level adjustment, tiltable to 5°, with covers class A / B, D according to EN 124 in cast iron (can be driven over by cars and trucks), incl. lift-out key. Inlet and outlet Ø ... for synthetic material pipes in: PE-HD (according to EN 12666-1); PVC pipe (according to EN 1401-1); PP or AS.

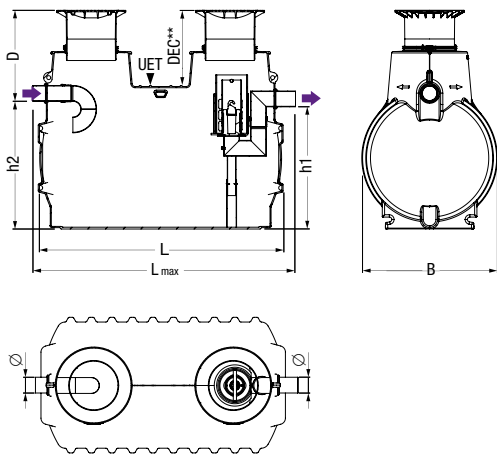
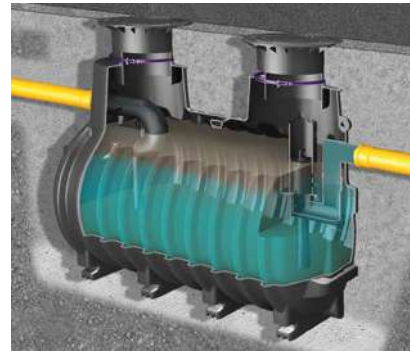
Note:

- Suitable for filling stations with high-performance filling pumps, E10 and biodiesel fuels
- Choose separator size and article number from table below.

Contact KESSEL for separator sizing support if required

- **Accessories:** Sampling chamber for underground installation, extension section for deep installation, alarm units for when the maximum oil level is reached and there is a back-up of water (required according to EN 858 Part 1), oil and sludge suction system, coalescence filter insert for retrofitting to the coalescence separator, *SonicControl* page 397 – 399, pumping stations see chapter "3"

- **Technical note:** page 394



NS	Installation depth D (min/max) in mm	Art. no.
Cover class A / B		
NS 3	710 - 1170	99 403.10B EX
NS 6	735 - 1195	99 606.30B EX
NS 6	735 - 1195	99 606.80B EX
NS 10	710 - 1170	99 610.15B EX
NS 10	735 - 1195	99 610.30B EX
NS 10	735 - 1195	99 610.80B EX
NS 15	735 - 1195	99 615.80B EX
NS 20	735 - 1195	99 620.80B EX
Cover class D		
NS 3	710 - 1170	99 403.10D EX
NS 6	735 - 1195	99 606.30D EX
NS 6	735 - 1195	99 606.80D EX
NS 10	710 - 1170	99 610.15D EX
NS 10	735 - 1195	99 610.30D EX
NS 10	735 - 1195	99 610.80D EX
NS 15	735 - 1195	99 615.80D EX
NS 20	735 - 1195	99 620.80D EX

NS	Ø* (mm)	Sludge trap capacity (l)	L (mm)	B (mm)	h1 (mm)	h2 (mm)	Oil storage capacity (l)	Excess level	Weight (kg)	Total volume (l)	D-DEC	Lmax
3	160	1000	2390	1200	1070	1100	215	90	379	1800	155	2642
6	200	2500 ¹⁾	2590	1760	1600	1630	380	120	519	4300	180	2940
6	200	5000	3110	1760	1600	1630	470	130	594	5800	180	3460
10	160	1500	2910	1200	1070	1100	267	100	424	2600	155	3162
10	200	2500 ¹⁾	2590	1760	1600	1630	380	120	519	4300	180	2940
10	200	5000	3110	1760	1600	1630	470	130	594	5800	180	3460
15	200	5000	3110	1760	1600	1630	470	130	594	5800	180	3460
20	200	4000	3110	1760	1600	1630	470	130	600	5800	180	3460

* Ø = Inlet and outlet outer diameter (mm)

¹⁾ Comparable sludge trap total volume in accordance with the dimensioning according to EN 858-2.

Oil-/fuel separator *EasyOil* ground NS 1.5, class II for underground installation



KESSEL factory standard

Made of polyethylene

Consisting of: Sludge trap, upper sections made of polymer, continuous height and level adjustment, self-actuated closure lock, inlet and outlet \varnothing 110 mm.

Cover:

Class B (\varnothing 800 / 400)

Class D (\varnothing 1000 / 800), with *Lock & Lift* function

Optional: Backwater valve according to DIN 13564

Note: Not suitable for *SonicControl*

- **Accessories \varnothing 400:** Sampling chamber for underground installation from page 374, pumping stations see chapter "3"
- **Accessories \varnothing 800 / 1000:** Sampling chamber for underground installation, alarm unit to signal maximum oil level and overflow - available as accessory (required based on EN 858) from page 397, pumping stations see chapter "3"
- **Technical note:** page 394



Illustration shows
Art. no. 99 601.041D



Illustration shows
Art. no. 99 601.016B/D



Illustration shows
Art. no. 99 601.002B

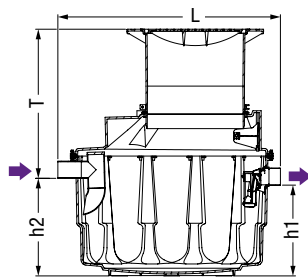


Illustration shows Art. no. 99 601.041D

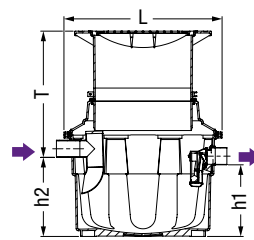


Illustration shows Art. no. 99 601.016B/D

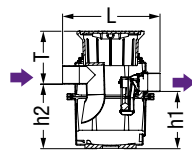


Illustration shows Art. no. 99 601.002B

Ø	Ø (mm)	Sludge trap capacity (l)	L (mm)	B (mm)	h1 (mm)	h2 (mm)	Oil storage capacity (l)	Excess level	Weight (kg)	Total (l)	Installation depth D (min/max) in mm		Art. no.	
											Ø	Art. no.		
												Cover class B		
400	110	17	582	520	342	389	17.6	50	12	34.6	400	231 - 324	99 601.002B	
800	110	130	1091	1012	461	508	70.5	50	74	200.5	800	483 - 967	99 601.016B	
												Cover class D, with <i>Lock & Lift</i> function		
800	110	130	1091	1012	461	508	70.5	50	74	200.5	800	483 - 967	99 601.016D	
1000	110	360	1425	1300	583	630	110	70	110	417	1000	535 - 1020	99 601.041D	

Accessories

Oil-/fuel separator / Coalescence separator for underground installation

Sampling chamber Ø 400

Cover class A

Compatibility: For connection to outlet pipe of separator; for oil-/fuel separator / coalescence separator for underground installation

Installation depth (D): 400 - 1300 mm (minimum installation depth can be achieved by cutting off)

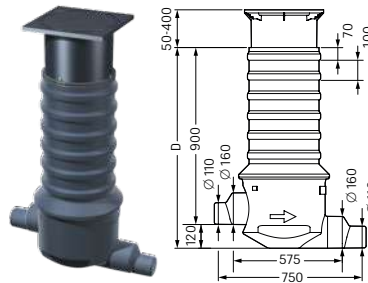
Drop height: 120 mm (160 mm on request)

Inclusive: Telescopic upper section with clamping ring, cover class A / B / D, sealed odour-tight

Extension: 600 mm with extension section Art. no. 915 402

Cover class B

Cover class D



In-/Outlet **Art. no.**

Ø 110/160 **915 880A**

Ø 110/160 **915 880B**

Ø 110/160 **915 880D**

Sampling chamber Ø 450

Cover class A

Compatibility: For connection to outlet pipe of separator; for oil-/fuel separator / coalescence separator for underground installation

Installation depth (D): 950 - 1300 mm

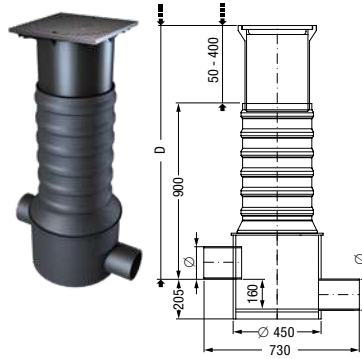
Drop height: 160 mm

Inclusive: Telescopic upper section with clamping ring, cover class A/B/D, sealed odour-tight

Extension: 600 mm with extension section Art. no. 915 402

Cover class B

Cover class D



In-/Outlet **Art. no.**

Ø 110 **915 881A**

Ø 160 **915 882A**

Ø 200 **915 883A**

Ø 260 **915 884A**

Ø 110 **915 881B**

Ø 160 **915 882B**

Ø 200 **915 883B**

Ø 260 **915 884B**

Ø 110 **915 881D**

Ø 160 **915 882D**

Ø 200 **915 883D**

Ø 260 **915 884D**

Sampling chamber Ø 1000

Cover class A / B

Compatibility: For separation systems NS 1 - NS 20 and special models for underground installation

Installation depth (D): 1145 - 1585 mm (Other installation depths available on request)

Drop height: 160 mm

Inclusive: Inlet and outlet Ø ... for synthetic material pipes in: PE-HD (according to EN 12666-1); PVC-KG (according to EN 1401-1); PP or AS. With integrated access steps, with vertically height-adjustable upper section made of polymer, with cover class A/B, D according to EN 124 in cast iron sealed odour-tight, incl. removal mechanism.

Cover class D, with Lock & Lift function



Outer diameter Ø (mm) **Suitable for separator** **Art. no.**

Ø 110 NS 1, NS 2, NS 4 **915 10 10B**

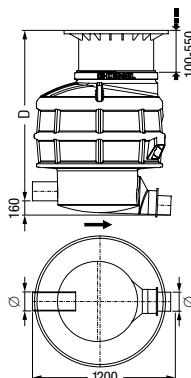
Ø 160 NS 7, NS 10 **915 10 15B**

Ø 200 NS 15, NS 20* **915 10 20B**

Ø 110 NS 1, NS 2, NS 4 **915 10 10D**

Ø 160 NS 7, NS 10 **915 10 15D**

Ø 200 NS 15, NS 20* **915 10 20D**



* Suitable for individual solutions

Accessories

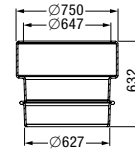
Oil-/fuel separator / Coalescence separator for underground installation

Extension section

Art. no.

Extension section

Compatibility: For underground grease separators with 600 mm access cover
Height increase: 500 mm



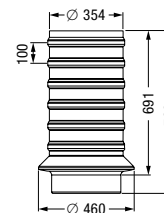
917 460

Extension section

Art. no.

Extension section

Compatibility: For sampling chamber Ø 400 and Ø 450 for underground installation
Extension height: max. 600 mm (can be shortened on-site)
Check maintenance accessibility!



915 402

SonicControl level sensing system

Type

Art. no.

Oil layer thickness and back-up / overflow warning

Compatibility: For oil- / coalescence separators from NS 3 for underground installation
Inclusive: Ultra sonic sensor for centimeter accurate monitoring and display of oil / fuel layer thickness along with backwater / flooding alarm; ATEX certification; power connection, battery back up, connection for remote speaker



OA

917 826

Oil layer thickness

Voltage: 230 V ~ 50 Hz
Protection type: IP 54
Plug: Schuko (double pole)
Cable length: 30 m with cable duct set. The sensor cable can be extended to a total length of 60 m. Cable extension set see below
Certification: BVS 11 ATEX E 040 X
 • Sensor can be used in explosive areas (Zone 0)
 • Acc. to RL 2014/34/EU designed in ignition protection class „Intrinsic safety“

O

917 828

back-up / overflow warning

A

917 830

Cable access conduit

Art. no.

Cable access conduit

Compatibility: For oil-/fuel separator / coalescence separator for underground installation according to EN 1825 and DIN 4040; for watertight connection of SonicControl cable into separator chamber
Inclusive: Gasket, cable connection, extension, sensor bracket
Note: Conduit pipe with chase wire should be planned; requires 50 mm OD conduit pipe (PE-HD) -sourced on-site. Max. distance 30 m



917 822

Cable extension set for SonicControl

for oil / coalescence separators

Art. no.

10 m extension

917 861

20 m extension

917 862

30 m extension



917 863



Accessories

Oil-/fuel separator / Coalescence separator for underground installation


Safety

			Art. no.
TeleControl telemetric system	<p>Compatibility: For connection to KESSEL Comfort control units 230 Volt and 400 Volt</p> <p>Function: Relaying of full text messages to up to three mobile phones</p> <p>Inclusive: With internal antenna (without SIM card)</p>		28 792
Antenna booster with magnetic base	<p>Compatibility: For TeleControl telemetric system to improve the reception</p> <p>Cable length: 2.5 m</p>		28 793
Extension cable	<p>Compatibility: For antenna booster</p> <p>Cable length: 2 m</p>		28 794


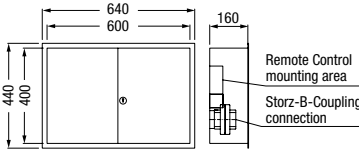
Oil/fuel / Sludge suction system


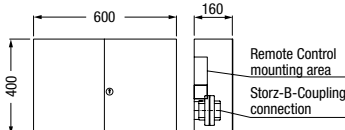
		Outer diameter Ø (mm)	Art. no.
Oil / fuel suction system	<p>Compatibility: For direct suction of oil / fuel into disposal vehicle, for inlet Ø 160 and Ø 200</p> <p>Inclusive: Storz B connection coupling</p>	<p>Ø 160</p> <p>Ø 200</p>	<p>917 803</p> <p>917 808</p>
Sludge suction system	<p>Compatibility: For direct suction of sludge / sediment into disposal vehicle, for inlet Ø 160 and Ø 200</p> <p>Inclusive: Storz B connection coupling</p>	<p>Ø 160</p> <p>Ø 200</p>	<p>917 804</p> <p>917 809</p>

Coalescence filter insert

			Art. no.
Coalescence filter insert	<p>Compatibility: For retrofitting the KESSEL Oil/fuel separator NS 3 - NS 15 to coalescence separator with two covers</p>		917 805

Access panel

		Width×Height×Depth in mm	Art. no.
Recessed wall installation	<p>Material: Stainless steel</p> <p>Compatibility: For Storz-B disposal pipe hook up connection and remote control connection for use with fully automated separators. Remote control not included</p> <p>Inclusive: 2 doors, lockable</p> <p>Note: Special dimensions on request</p>		917 414
		 <p>640 600 440 400 160 Remote Control mounting area Storz-B-Coupling connection</p>	

		Width×Height×Depth in mm	Art. no.
Wall installation	<p>Material: Stainless steel</p> <p>Compatibility: For Storz-B disposal pipe hook up connection and remote control connection for use with fully automated separators. Remote control not included</p> <p>Inclusive: 2 doors, lockable</p> <p>Note: Special dimensions on request</p>		917 413
		 <p>600 400 160 Remote Control mounting area Storz-B-Coupling connection</p>	

5.3 Sediment separators

Wastewater pipe blockage prevention.
Removal of solids (sand, stones, ...)
from wastewater stream

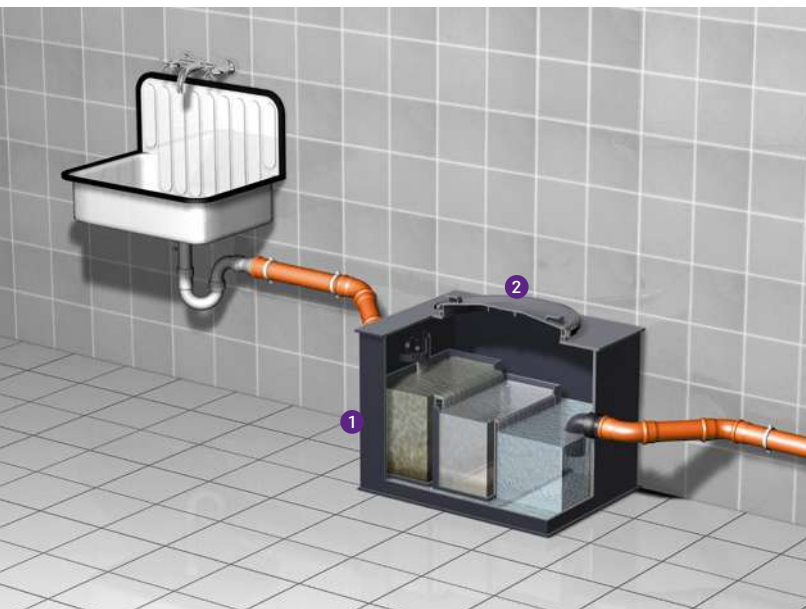
Sediment separators

EasySink free / ground

The clean solution for wastewater with sediment, sand or sludge.

The clean solution for sediments, sand and sludge. The sediment separator *EasySink* prevents residues, such as plaster, scale and clay, from entering the sewer system. It is used wherever a lot of sludge, sand and sediment / debris occurs and can lead to blockages in the sewer system.

We offer sediment separators with the nominal sizes NS 1 and NS 2 for free-standing set-up, for installation in the ground and as individual solutions in all desired sizes.



1 Sediment separator 2 Access cover

Polymer

Polymer sediment separators are an advantageous alternative to metal solutions as they are fully corrosion free. The polyethylene material used is particularly durable. In addition to the statutory provision, we provide a 20-year warranty with regard to the leak tightness, fitness for purpose and structural safety of tanks and upper sections.

Sediment separator *EasySink* free NS 1 – 2

for free-standing installation



Made of polyethylene

Installation: For free installation in frost protected areas

Consisting of:

With removable polymer collection tank(s), polymer inlet cover and outlet odour trap, sealed with odour-tight domed cover.

Inlet/outlet \emptyset for plastic adapter DIN 19534

Delivery: System completely assembled

Delivery scope: Tank with access cover and removable collection tank(s)

NS 1: 1 collection tank

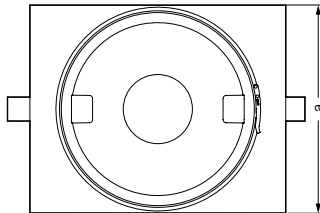
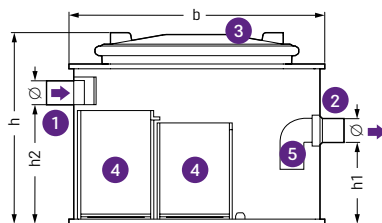
NS 2: 2 collection tank

Note: Further nominal sizes on request



Illustration shows Art. no. 97 202/000

NS	Art. no.
NS 1	97 201/000
NS 2	97 202/000



- 1 Inlet
- 2 Outlet
- 3 Domed cover
- 4 Collection tank
- 5 Odour trap

NS	\emptyset (mm)	a (mm)	b (mm)	h (mm)	h1 (mm)	h2 (mm)	Weight (kg)	Tank volume (l)
1	50	400	570	470	195	305	17	13
2	70	650	800	596	255	373	50	51

\emptyset = Outer diameter

Sediment separator *EasySink* ground Ø 400 NS 1 – 2

for underground installation



KESSEL factory standard

Made of polyethylene

Consisting of:

With removable sediment container (hole diameter 5 mm), outlet odour trap. Vertically adjustable upper section with cover class A / B / D, odour-tight seal.

Inlet / outlet Ø 110 for plastic adapter DIN 19534;

Delivery scope:

NS 1: 1 sediment container (12 l) removable

NS 2: 1 sediment container (12 l) + 1 sediment container (20 l)

both are removable

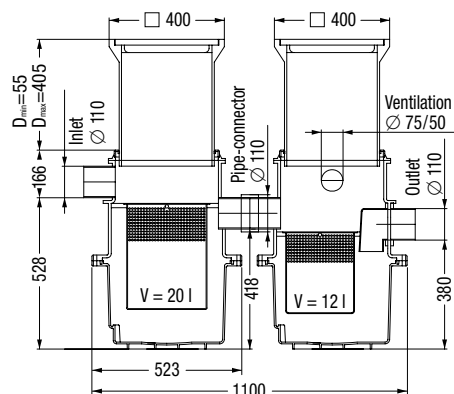
Delivery: System completely assembled

Options: Inlet / outlet Ø = 40, 50, 75 mm

Stainless steel sediment containers with hole diameter:

3, 6, 8, 10, 12, 15 mm

Optional fine filter (mesh width 1.0 mm)



NS	Weight in kg	Art. no.
Cover class A		
NS 1	25	97 201/00A
NS 2	45	97 202/00A
Cover class B		
NS 1	25	97 201/00B
NS 2	45	97 202/00B
Cover class D		
NS 1	25	97 201/00D
NS 2	45	97 202/00D

5.4 Starch separators

Starch removal from commercial wastewater (from potato peeling wastewater)

Starch separator *EasyStarch* free / ground

The strong solution for starchy wastewater.

Strong-acting against starch: *EasyStarch*. Starch occurs during the processing of potatoes, rice and grain. The starch separator *EasyStarch* is used to prevent deposits, encrustations and blockages in the drainage pipes.

The *EasyStarch* is available for free-standing installation and underground installation. Please get in touch with us – we will be happy to advise you and develop an individual solution for your specific requirements.



1 Starch separator 2 Sampling chamber 3 Lifting station

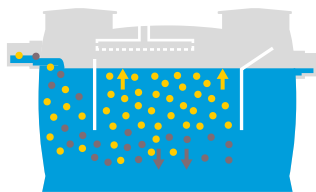
Polymer

Polymer starch separators are an advantageous alternative to metal solutions as they do not need to be refurbished, even after many years. The polyethylene material used is particularly durable. In addition to the statutory provision, we provide a 20-year warranty with regard to the leak tightness, fitness for purpose and structural safety of tanks and upper sections.



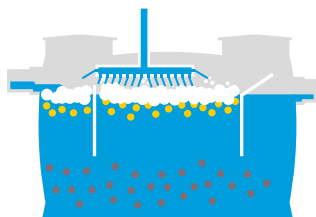
What happens inside a starch separator?

Starch settles to the base of a starch separator due to it being heavier than water. However, foam formation can be expected inside the separator which needs to be reduced by an internal foam reduction spray system.



Wastewater discharge

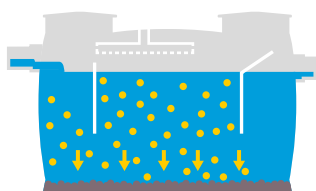
Wastewater from the potato peeling machine is discharged into the starch separator via a flow calming section (calming section at least 1 m)



Formation of foam layer

Starch foam is reduced by a water spray system. Where possible, the water connection of the spray system is activated by switching on the potato peeler machine.

Option: Additional device for water spray system (#ZESA40) Submersible pump operates the spray system with water from the clean water zone of the starch separator.



Formation of starch layer

Spraying the starch foam causes the starch to settle to the bottom of the tank. The treated wastewater flows out of the starch separator via gravity.

Starch separators *EasyStarch* free Standard NS 0.5 – 3

for free-standing installation



EN 1825

Tank

Manufactured from virgin, non-recycled polyethylene, for free standing installation in frost protected areas, foam suppressing rinsing rod system, sloped interior base improves cleaning and reduces disposal time, inlet flow calming system and outlet flow regulation device, slanted twin access covers with quick release odour tight snap closures, integrated fork lift grips at base of separator, 100 % corrosion free polyethylene body construction (20 year warranty).

Disposal System

Standard version requires disposal truck with vacuum system for separator disposal.

Delivery: System completely assembled.

Recommended accessory: ZESA40

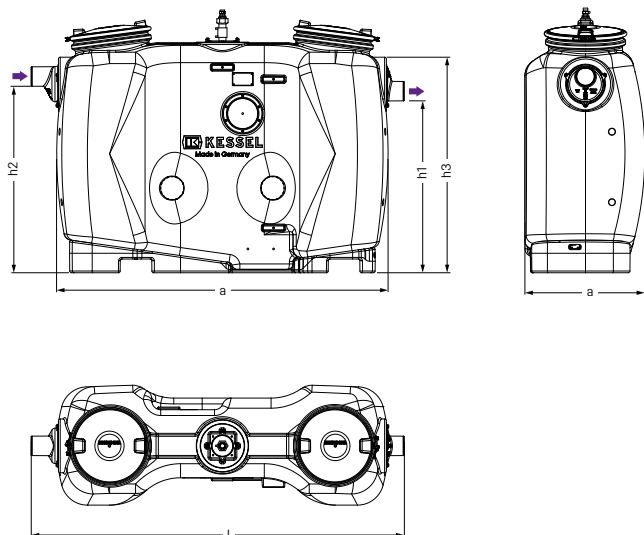
ZESA40 is a water supply system for the foam suppressing system consisting of a pump (Type GTF 500), suction hose (DN32/PN6) and high-pressure pipe DN32/PN6 (DA = 40 × 2.3 mm), control unit

➤ **Accessories:** Sampling chamber page 394

➤ **Technical note:** page 356



NS	Art. no.
Without accessories	
NS 0.5	94 200.01
NS 1	94 201.01
NS 2	94 202.01
NS 3	94 203.01



NS	Ø (mm)	a (mm)	Installation dimension l × b (mm)	h1 (mm)	h2 (mm)	h3 (mm)	Weight (kg)	Total (l)
0.5	110	1500	1735 × 680	985	1055	1435	84	600
1	110	1880	2115 × 680	985	1055	1435	97	800
2	110	1910	2145 × 940	1185	1255	1655	145	1350
3	110	2590	2820 × 940	1185	1255	1655	191	1900

Ø = Outer diameter

Article index

List of article numbers and page numbers

Art. no.	Page	Art. no.	Page	Art. no.	Page	Art. no.	Page
1							
11 000	113	11 079	112	22 005	87	27 602	136
11 001	113	11 080	112	22 006	87	27 603	299
11 002	113	11 082	111	22 007	87	27 609	298
11 003	113	11 082-900l	110	22 200	93	27 611	288
11 006	113	11 083	111	22 201	93	27 621	288
11 007	113	11 085	113	22 202	93	27 631	286
11 009	112	11 086	113	22 203	93	27 641	286
11 010	112	11 088	113	22 205	93	27 650	294
11 011	112	11 090	112	24 100	29	27 651	287
11 012	112	11 091	112	24 100S	28	27 660	294
11 015	112	11 092	112	24 100X	28	27 671	286
11 016	112	11 095	113	24 125	29	28 014	139
11 018	113	11 096	113	24 125S	28	28 015	139
11 019	113	11 098	113	24 125X	28	28 016	139
11 020	113	11 100	112	24 150	29	28 020	141
11 021	113	11 101	112	24 150S	28	28 021	141
11 024	113	11 103	112	24 150X	28	28 040	135
11 025	113	11 105	113	24 200	29	28 041	141
11 027	112	11 106	113	24 200S	28	28 042	141
11 028	112	11 108	113	24 200X	28	28 043	141
11 029	112	11 110	112	27 118	202	28 044	141
11 030	112	11 111	112	27 126	136	280 451S	283
11 033	112	11 113	112	27 140	309	280 451X	283
11 034	112	11 115	111	27 141	309	28 048	92
11 036	113	11 116	111	27 146	212	280 500S	128
11 037	113	11 118	111	27 157	299	280 500SC	128
11 038	113	11 120	113	27 165	211	280 500X	128
11 039	113	11 121	113	27 168	213	280 500XC	128
11 042	113	11 123	112	27 169	299	280 530S	127
11 043	113	11 124	112	27 170	309	280 530SC	127
11 045	112	11 126	111	27 171	309	280 530X	127
11 046	112	11 127	111	27 176	210	280 530XC	127
11 047	112	11 604	114	27 177-PL	261	280 550S	127
11 048	112	11 605	114	27 177-PLF	261	280 550SC	127
11 051	112	11 606	114	27 177-PLF-KF	261	280 550X	127
11 052	112	11 607	114	27 177-PL-KF	261	280 550XC	127
11 054	111	11 608	114	27 182	277	280 570S	133
11 054-900l	110	11 609	114	27 185	277	280 570SC	133
11 055	111	142 025	259	27 186	277	280 570X	133
11 057	111	142 026	259	27 191G	260	280 570XC	133
11 059	113	142 025	252	27 192	211	28 062	135
11 060	113	142 025.20	252	27 196	210	28 067	141
11 061	113	142 025.21	252	27 196G	211	28 068	140
11 062	113	142 025.30	252	27 198	212	280 710	175
11 064	112	142 025.52	252	27 199	212	280 750	175
11 065	112	142 026	253	27 201	210	28 076	65
11 066	112	142 026.20	253	27 202	210	28 078	141
11 067	112	142 026.21	253	27 205	299	280 810	175
11 069	111	142 026.30	253	27 210	211	28 082	179
11 069-900l	110	142 026.52	253	27 211	211	280 850	175
11 070	111	185-043	179	27 218	210	28 086	137
11 072	113	185-045	179	27 219	210	28 088	169
11 073	113			27 220	210	28 089	169
11 074	113	2		27 221	210	28 090	170
11 075	113	20 162	56	27 225	210	28 091	170
11 077	112	20 222	134	27 226	210	28 092	170
11 078	112	20 223	134	27 298	297	28 093	137
		20 224	134	27 301	289	28 094	170
		22 004	87	27 308	299	28 095	170
				27 600	294	28 097	137

Art. no.	Page	Art. no.	Page	Art. no.	Page	Art. no.	Page
281 200S	128	28 731 DS	177	3		42 701	211
281 200SC	128	28 731 LL	178		42 701.20	209	
281 200X	128	28 731 P	176		42 701.50	209	
281 200XC	128	28 731 PS	176		42 701.54	209	
281 230S	127	28 731 S	177		42 701.91	208	
281 230SC	127	28 731 SX	177		42 701.95	209	
281 230X	127	28 740	175		42 703	211	
281 230XC	127	28 740C	175		43 401	212	
281 250S	127	28 746 D	177		43 401.91	212	
281 250SC	127	28 746 DL	177		43 401.93	212	
281 250X	127	28 746 DO	177	43 500	213		
281 250XC	127	28 746 DS	177	43 700	213		
28 511	125	28 746 LLLF	178	43 710	212		
28 512	125	28 746 LLV	178	43 711	212		
28 513	124	28 746 P	176	43 730	212		
28 514	124	28 746 PS	176	44 700	201		
28 515	124	28 746 S	177	44 700.20	197		
28 516	124	28 746 SX	177	44 700.20M	197		
28 517	123	28 751	115	44 700.51	199		
28 518	123	28 752	115	44 700.52	198		
28 520	121	28 753	115	44 700.53	198		
28 561	132	28 754	115	44 700.62	197		
28 561C	132	28 755	178	44 700.63	197		
28 562	132	28 756	178	44 700.66	197		
28 562C	132	28 757	178	44 701	201		
28 563	132	28 758	178	44 702	202		
28 563C	132	28 759	178	44 703	202		
28 628-C	114	28 760	174	44 704	202		
28 629-C	114	28 760C	174	44 740	200		
28 646-C	115	28 761	178	44 740.20	196		
28 648-C	115	28 762	178	44 740.20M	196		
28 660	139	28 763	178	44 740.62	196		
28 661	139	28 764	114	44 740.62M	196		
28 662	139	28 765	114	44 740.63	196		
28 663	139	28 766	114	44 740.63M	196		
28 680	140	28 767	114	44 740.66M	196		
28 682	140	28 778	174	44 740M	200		
28 683	140	28 779	174	44 750	200		
28 698	140	28 781	178	44 750.20	196		
28 699	140	28 783	178	44 750.20M	196		
28 701S	119	28 785	180	44 750.62	196		
28 701SC	119	28 792	91	44 750.62M	196		
28 701X	119	28 793	91	44 750.63	196		
28 701XC	119	28 794	91	44 750.63M	196		
28 704S	119	28 798	117	44 750.66M	196		
28 704SC	119	28 799	169	44 750M	200		
28 704X	119	28 840	175	45 100	218		
28 704XC	119	28 840C	175	45 100.01	218		
28 712	140	28 860	174	45 100.02	218		
28 713	140	28 860C	174	45 100.03	218		
28 714	140	29 101	294	45 101.20	203		
28 715	140	29 102	294	45 102	218		
28 716	140	29 103	294	45 102.01	218		
28 717	120	29 111	288	45 102.02	218		
28 717C	120	29 121	288	45 102.03	218		
28 718	120	29 131	286	45 103	218		
28 718C	120	29 141	286	45 103.01	218		
28 731 D	177	29 151	287	45 103.02	218		
28 731 DL	177			45 103.03	218		
28 731 DO	177			45 104.01	218		
				46 100	211		
				46 150	210		
				46 150.20	206		
				46 150.30	207		
				46 150.50	204		
				46 150.51	204		
				46 150.54	204		
				46 150.66	206		
				46 150.90	205		
				46 151	210		
				46 159.50	205		
				46 170	210		
				46 170.20	206		
				46 170.30	207		
				46 170.50	204		
				46 170.51	204		
				46 170.54	204		
				46 170.66	206		
				46 170.90	205		
				46 171	210		
				46 179.50	205		
				46 250	210		
				46 250.20	206		
				46 250.30	207		
				46 250.50	204		
				46 250.51	204		
				46 250.54	204		
				46 250.66	206		
				46 250.90	205		
				46 251	210		
				46 259.50	205		
				46 270	210		
				46 270.20	206		
				46 270.30	207		
				46 270.50	204		
				46 270.51	204		
				46 270.54	204		
				46 270.66	206		
				46 270.90	205		
				46 271	210		
				46 279.50	205		
				46 700	211		

Art. no.	Page	Art. no.	Page	Art. no.	Page	Art. no.	Page
45 104.02	218	45 210.63	241	45 600.67M	219	48 310.02	319
45 104.03	218	45 218.11	243	45 950	321	48 310.03	319
45 110	221	45 219	240	45 970	321	48 311	221
45 110.11	241	45 219.11	240	47 804S	210	48 312	319
45 110.40	242	45 219.51	240	47 805S	210	48 312.01	319
45 110.51	241	45 219.53	240	47 806S	210	48 312.02	319
45 110.53	241	45 219.63	240	47 807S	210	48 312.03	319
45 110.63	241	45 250	221	47 808S	210	48 335	322
45 119	240	45 250.11	241	47 809S	210	48 345	322
45 119.11	240	45 250.20	243	47 810S	210	48 351	323
45 119.51	240	45 250.51	241	47 811S	210	48 352	323
45 119.53	240	45 250.53	241	47 812S	210	48 353	323
45 119.63	240	45 250.63	241	47 900	213	48 354	323
45 150	221	45 259	240	47 901	211	48 358	221
45 150.11	241	45 259.11	240	47 902	211	48 370	319
45 150.51	241	45 259.51	240	47 904	210	48 370.01	319
45 150.53	241	45 259.53	240	47 905	210	48 370.02	319
45 150.63	241	45 259.63	240	47 906	211	48 370.03	319
45 159	240	45 270	221	48 000M	228	48 378	221
45 159.11	240	45 270.11	241	48 003M	229	48 383	221
45 159.51	240	45 270.20	243	48 000.01M	228	48 400	222
45 159.53	240	45 270.51	241	48 000.02M	228	48 403	247
45 159.63	240	45 270.53	241	48 000.03M	228	48 407	222
45 170	221	45 270.63	241	48 000.04M	228	48 409	202
45 170.11	241	45 279	240	48 003.41M	229	48 410	222
45 170.51	241	45 279.11	240	48 003.42M	229	48 411	221
45 170.53	241	45 279.51	240	48 003.43M	229	48 411.11	236
45 170.63	241	45 279.53	240	48 003.44M	229	48 411.51	236
45 179	240	45 279.63	240	48 011	228	48 411.53	236
45 179.11	240	45 300.08	216	48 012	228	48 411.63	236
45 179.53	240	45 300.09	216	48 013	228	48 435	257
45 179.63	240	45 300.10	216	48 014	228	48 458	221
45 200.08	217	45 300.11	216	48 063	228	48 458.11	236
45 200.09	217	45 300.12	216	48 099	247	48 458.51	236
45 200.10	217	45 300.14	216	48 100	247	48 458.53	236
45 200.11	217	45 300.16	216	48 165	200	48 458.63	236
45 200.12	217	45 301	322	48 168	247	48 478	236
45 200.14	217	45 302.08	216	48 176	245	48 478.11	236
45 200.16	217	45 302.09	216	48 193	201	48 478.51	236
45 202.08	217	45 302.10	216	48 200	278	48 478.53	236
45 202.09	217	45 302.11	216	48 201	200	48 478.63	236
45 202.10	217	45 302.12	216	48 202	200	48 483	221
45 202.11	217	45 303.08	216	48 203	200	48 483.11	236
45 202.12	217	45 303.09	216	48 204	200	48 483.51	236
45 203.08	217	45 303.10	216	48 206	201	48 483.53	236
45 203.09	217	45 303.11	216	48 207	201	48 483.63	236
45 203.10	217	45 303.12	216	48 209	201	48 500	55
45 203.11	217	45 304.08	216	48 211	201	48 501	304
45 203.12	217	45 304.09	216	48 218	200	48 502	304
45 204.08	217	45 304.10	216	48 219	200	48 503	304
45 204.09	217	45 304.11	216	48 220	200	48 504	304
45 204.10	217	45 304.12	216	48 221	200	48 511	235
45 204.11	217	45 600.59M	219	48 225	200	48 511.11	235
45 204.12	217	45 600.60M	219	48 226	200	48 511.51	235
45 210	221	45 600.61M	219	48 227	200	48 511.53	235
45 210.11	241	45 600.62M	219	48 228	200	48 511.63	235
45 210.20	243	45 600.63M	219	48 300	322	48 520	309
45 210.40	242	45 600.64M	219	48 302	322	48 550	55
45 210.51	241	45 600.65M	219	48 310	319	48 558	235
45 210.53	241	45 600.66M	219	48 310.01	319	48 558.11	235

Art. no.	Page	Art. no.	Page	Art. no.	Page	Art. no.	Page
48 558.51	235	48 778.11	234	48 978	252	54 430.52	251
48 558.53	235	48 778.51	234	48 981	246	54 430.61	251
48 558.63	235	48 778.53	234	48 982	298	54 900	275
48 578	235	48 778.63	234	48 987	246	54 901	275
48 578.11	235	48 783	234	48 988	277	54 902	275
48 578.51	235	48 783.11	234	48 989	246	54 903	275
48 578.53	235	48 783.51	234	48 990	247	54 910	256
48 578.63	235	48 783.53	234	48 991	247	54 911	254
48 583	235	48 783.63	234			54 912	256
48 583.11	235	48 800	222			54 913	254
48 583.51	235	48 811	234			54 914	245
48 583.53	235	48 811.01	304			54 915	255
48 583.63	235	48 811.11	234			54 916	245
48 600	247	48 811.51	234			54 917	254
48 611	235	48 811.53	234			54 919	255
48 611.11	235	48 811.63	234			54 920	256
48 611.51	235	48 812	305			54 923	255
48 611.53	235	48 858	234			54 926	256
48 611.63	235	48 858.11	234			54 928	254
48 618	200	48 858.51	234			54 929	255
48 619	200	48 858.53	234			55 350	253
48 620	200	48 858.63	234			55 350.20	253
48 621	200	48 878	234			55 350.21	253
48 625	200	48 878.01	304			55 350.30	253
48 626	200	48 878.11	234			55 350.52	253
48 630	222	48 878.51	234			55 400	253
48 636	276	48 878.53	234			55 400.20	253
48 639	222	48 878.63	234			55 400.21	253
48 640	222	48 879	305			55 400.30	253
48 650	212	48 883	234			55 400.52	253
48 651	212	48 883.11	234			55 550	252
48 658	235	48 883.51	234			55 550.20	252
48 658.11	235	48 883.53	234			55 550.21	252
48 658.51	235	48 883.63	234			55 550.30	252
48 658.53	235	48 889	305			55 550.52	252
48 658.63	235	48 900	246			55 550-KF	258
48 669	200	48 904	200			55 600	252
48 670	200	48 905	200			55 600.20	252
48 678	235	48 906	201			55 600.21	252
48 678.11	235	48 907	250			55 600.30	252
48 678.51	235	48 928M	221			55 600.52	252
48 678.53	235	48 929M	221			55 600-KF	258
48 678.63	235	48 930M	221			57 410	258
48 683	235	48 931M	221			57 410-KF	259
48 683.11	235	48 932M	221			57 415	258
48 683.51	235	48 950	201			57 415-KF	259
48 683.53	235	48 951	201			57 420	259
48 683.63	235	48 952	305			57 420-KF	258
48 700	55	48 954	295			57 425	259
48 711	234	48 954-SL	277			57 425-KF	258
48 711.11	234	48 954-S-V2A-KF	259			57 435	259
48 711.51	234	48 958	298			57 410	252
48 711.53	234	48 963	201			57 420	252
48 711.63	234	48 964	295			59 010	254
48 758	234	48 965	250			59 011	256
48 758.11	234	48 966	297			59 012	255
48 758.51	234	48 967	298			59 013	256
48 758.53	234	48 968	277			59 014	255
48 758.63	234	48 969	252			59 165	245
48 778	234	48 977	257			59 192	245

5

500 100	65	54 914	245
500 101	65	54 915	255
500 102	136	54 916	245
50 100	313	54 917	254
51 101	291	54 919	255
51 102	294	54 920	256
52 101	291	54 923	255
52 102	294	54 926	256
54 187	275	54 928	254
54 188	276	54 929	255
54 189	275	55 350	253
54 200	250	55 350.20	253
54 200.20	250	55 350.21	253
54 200.21	250	55 350.30	253
54 200.52	250	55 350.52	253
54 200.61	250	55 400	253
54 210	250	55 400.20	253
54 210.20	250	55 400.21	253
54 210.21	250	55 400.30	253
54 210.52	250	55 400.52	253
54 210.61	250	55 550	252
54 220	250	55 550.20	252
54 220.20	250	55 550.21	252
54 220.21	250	55 550.30	252
54 220.52	250	55 550.52	252
54 220.61	250	55 550-KF	258
54 230	250	55 600	252
54 230.20	250	55 600.20	252
54 230.21	250	55 600.21	252
54 230.52	250	55 600.30	252
54 230.61	250	55 600.52	252
54 400	251	55 600-KF	258
54 400.20	251	57 410	258
54 400.21	251	57 410-KF	259
54 400.52	251	57 415	258
54 400.61	251	57 415-KF	259
54 410	251	57 420	259
54 410.20	251	57 420-KF	258
54 410.21	251	57 425	259
54 410.52	251	57 425-KF	258
54 410.61	251	57 435	259
54 420	251	57 410	252
54 420.20	251	57 420	252
54 420.21	251	59 010	254
54 420.52	251	59 011	256
54 420.61	251	59 012	255
54 430	251	59 013	256
54 430.20	251	59 014	255
54 430.21	251	59 165	245
		59 192	245

Art. no.	Page	Art. no.	Page	Art. no.	Page	Art. no.	Page
59 305	260	61 02 401	270	62 40 250	266	67 923B	308
59 315	260	61 15 050	268	62 40 300	266	67 940	315
59 325	260	61 15 100	268	62 50 050	271	67 945	315
59 335	260	61 15 150	268	62 50 100	271	67 960	315
59 400	257	61 15 200	268	62 60 600	271	67 970	315
<hr/>							
6		61 15 250	268	62 80 800	271	67 985	277
60 00 100	271	61 15 300	268	63 00 100	272	67 986	309
60 02 100	269	61 20 050	268	63 02 100	270	67 997	315
60 02 101	269	61 20 100	268	63 02 101	270	680 071	92
60 02 140	269	61 20 150	268	63 02 140	270	680 125	65
60 02 141	269						
60 02 200	269	61 20 200	268	63 02 141	270	680 370	64
60 02 201	269	61 20 250	268	63 02 200	270	680 371	64
60 02 300	269	61 20 300	268	63 02 201	270	680 373	65
60 02 301	269	6125SKH	278	63 02 300	270	680 528	169
60 02 400	269	61 30 050	268	63 02 301	270	680 529	169
60 02 401	269	61 30 100	268	63 02 400	270	680 530	169
60 101S	299	61 30 150	268	63 02 401	270	680 531	169
60 15 050	265	61 30 200	268	63 20 050	267	680 696	55
60 15 100	265	61 30 250	268	63 20 100	267	680 795	55
60 15 150	265	61 30 300	268	63 20 150	267	680 796	55
60 15 200	265	61 35 035	272	63 20 200	267	680 797	55
60 15 250	265	61 40 050	268	63 20 250	267	680 798	55
60 15 300	265	61 40 100	268	63 20 300	267	680 941	218
60 20 050	265	61 40 150	268	63 30 050	267	680 986	139
60 20 100	265	61 40 200	268	63 30 100	267	680 987	139
60 20 150	265	61 40 250	268	63 30 150	267	681 040	138
60 20 200	265	61 40 300	268	63 30 200	267	681 041	138
60 20 250	265	61 50 050	272	63 30 250	267	681 042	138
60 20 300	265	61 50 100	272	63 30 300	267	681 043	138
60 30 050	265	61 60 600	272	63 35 035	272	681 044	168
60 30 100	265	61 80 800	272	63 40 050	267	681 045	168
60 30 150	265	62 00 100	271	63 40 100	267	681 046	91
60 30 200	265	6200SKN	278	63 40 150	267	681 047	91
60 30 250	265	62 02 100	269	63 40 200	267	681 111	136
60 30 300	265	62 02 101	269	63 40 250	267	681 148	93
60 35 035	271	62 02 140	269	63 40 300	267	7	
60 40 050	265	62 02 141	269	63 50 050	272	700 090	41
60 40 100	265	62 02 200	269	63 50 100	272	700 090.10S	41
60 40 150	265	62 02 201	269	63 60 600	272	700 090.10X	41
60 40 200	265	62 02 300	269	63 80 800	272	700 100	41
						700 100.10S	41
60 40 250	265	62 02 301	269	67 000	309	700 100.10X	41
60 40 300	265	62 02 400	269	67 007	309	700 125	41
60 50 050	271	62 02 401	269	67 020.30	308	700 125.10S	41
60 50 100	271	62 20 050	266	67 040	309	700 125.10X	41
60 60 600	271	62 20 100	266	67 060.30	308	700 150	41
60 80 800	271	62 20 150	266	67 110B	307	700 150.10S	41
61 00 100	272	62 20 200	266	67 111B	307	700 150.10X	41
6101SKH	278	62 20 250	266	67 300	277	700 200	41
61 02 100	270	62 20 300	266	67 301	277	700 200.10S	41
61 02 101	270	62 30 050	266	67 302	277	700 200.10X	41
61 02 140	270	62 30 100	266	67 304	278	70 100	44
61 02 141	270	62 30 150	266	67 305	278	70 125	44
61 02 200	270	62 30 200	266	67 400	309	70 150	44
61 02 201	270	62 30 250	266	67 500	309	70 200	44
61 02 300	270	62 30 300	266	67 600	309	70 203	44
61 02 301	270	62 35 035	271	67 700	316	70 205	44
61 02 400	270	62 40 050	266	67 750	316	70 214	55
		62 40 100	266	67 775	316		
		62 40 150	266	67 800	316		
		62 40 200	266	67 922B	308		

Art. no.	Page	Art. no.	Page	Art. no.	Page	Art. no.	Page
70 231	44	730 150.10X	38	80 102	60	827 720D	160
70 232	44	730 150.10XR	38	80 104	60	827 721A	160
70 233	56	730 150R	39	80 125	35	827 721B	160
70 234	56	730 200	39	80 125X	34	827 721D	160
70 241	44	730 200.10S	38	80 150	35	827 730A	160
70 242	44	730 200.10SR	38	80 150X	34	827 730B	160
70 261	44	730 200.10X	38	80 200	35	827 730D	160
70 262	44	730 200.10XR	38	80 200X	34	827 731A	160
71 100	43	730 200R	39	80 888	169	827 731B	160
71 125	43	73 050	46	80 889	54	827 731D	160
71 150	43	73 051	47	80 890	54	827 740A	160
71 200	43	73 052	47	80 891	54	827 740B	160
71 250	48	73 053	47	80 893	180	827 740D	160
71 300	48	73 070	46	824 811B	161	827 741A	160
71 400	48	73 100	43	824 811D	161	827 741B	160
71 500	48	73 100.10	33	824 821B	161	827 741D	160
720 090	40	73 100.10S	33	824 821D	161	827 750A	160
720 090.10S	40	73 100.10X	33	824 831B	161	827 750B	160
720 090.10X	40	73 100R	43	824 831D	161	827 750D	160
720 100	40	73 125	43	825 810B	161	827 751A	160
720 100.10S	40	73 125.10	33	825 810D	161	827 751B	160
720 100.10X	40	73 125.10S	33	825 811B	161	827 751D	160
720 125	40	73 125.10X	33	825 811D	161	827 810B	161
720 125.10S	40	73 125R	43	825 820B	161	827 810D	161
720 125.10X	40	73 150	43	825 820D	161	827 811B	161
720 150	40	73 150.10	33	825 821B	161	827 811D	161
720 150.10S	40	73 150.10S	33	825 821D	161	827 820B	161
720 150.10X	40	73 150.10X	33	825 830B	161	827 820D	161
720 200	40	73 150R	43	825 830D	161	827 821B	161
720 200.10S	40	73 200	43	825 831B	161	827 821D	161
720 200.10X	40	73 200.10	33	825 831D	161	827 830B	161
72 100	43	73 200.10S	33	826 711A	160	827 830D	161
72 100R	43	73 200.10X	33	826 711B	160	827 831B	161
72 125	43	76 100	43	826 711D	160	827 831D	161
72 125R	43	77 100	43	826 721A	160	828 711	163
72 150	43	79 100	49	826 721B	160	828 811	163
72 150R	43	79 1000	49	826 721D	160	828 851	163
72 200	43	79 125	49	826 731A	160	829 100	167
72 999	362	79 150	49	826 731B	160	829 200	167
730 090	39	79 200	49	826 731D	160	829 250	167
730 090.10S	38	79 250	49	826 741A	160	829 710	163
730 090.10SR	38	79 300	49	826 741B	160	829 711	163
730 090.10X	38	79 400	49	826 741D	160	829 810	163
730 090.10XR	38	79 500	49	826 751A	160	829 811	163
730 090R	39	79 600	49	826 751B	160	829 850	163
730 100	39	79 800	49	826 751D	160	829 851	163
730 100.10S	38			826 811B	161	830 050	54
730 100.10SR	38			826 811D	161	830 052	54
730 100.10X	38			826 821B	161	830 070	57
730 100.10XR	38			826 821D	161	830 073	57
730 100R	39	80 037	55				
730 125	39	80 072	56	826 831B	161	830 100	57
730 125.10S	38	80 074	134	826 831D	161	830 101	57
730 125.10SR	38	80 077	56	827 710A	160	830 200	57
730 125.10X	38	80 091	35	827 710B	160	830 202	57
730 125.10XR	38			827 710D	160	83 021	312
730 125.10SR	38	80 093	35				
730 125R	39	80 097	35	827 711A	160	83 022	312
730 150	39	80 098	35	827 711B	160	83 070	54
730 150.10S	38	80 100	35	827 711D	160	83 073	54
730 150.10SR	38	80 100X	34	827 720A	160	83 075	54
				827 720B	160	83 077	135

Art. no.	Page	Art. no.	Page	Art. no.	Page	Art. no.	Page
83 078	135	851 151D	311	874 00 36	62	874 01 78	88
83 079	135	851 152A	311	874 00 37	62	874 01 79	88
83 081	54	851 152B	311	874 00 38	63	874 01 80	88
83 082	54	851 152D	311	874 00 40	63	874 01 81	88
83 083	54	85 12 51	61	874 00 42	62	874 02 22	62
83 084	54	85 12 53	61	874 00 43	62	874 02 23	62
83 085	54	85 15 01	61	874 00 44	63	874 02 24	62
83 086	54	85 15 02	61	874 00 46	63	874 02 25	62
83 087	54	85 401	65	874 00 48	62	874 02 26	62
83 088	54	85 402	65	874 00 49	62	874 10 06	85
83 090	57	85 403	65	874 00 50	63	874 10 07	85
84 100	31	85 404	65	874 00 52	63	874 10 08	85
84 100S	31	860 109	65	874 00 54	62	874 10 09	85
84 100X	31	860 116	65	874 00 55	62	874 10 10	85
84 125	31	860 130	64	874 00 56	63	874 10 11	85
84 125S	31	860 131	64	874 00 58	63	874 10 12	85
84 125X	31	860 134	64	874 00 60	62	874 10 13	85
84 150	31	860 135	64	874 00 61	62	874 10 22	85
84 150S	31	860 152	64	874 00 62	63	874 10 23	85
84 150X	31	860 153	64	874 00 64	63	874 10 24	85
84 200	31	860 154	64	874 00 66	156	874 10 25	85
84 200S	31	860 155	64	874 00 67	156	874 10 26	85
84 200X	31	860 156	64	874 00 68	157	874 10 27	85
850 008	312	860 160	64	874 00 70	157	874 10 28	85
850 009	313	860 161	64	874 00 72	156	874 10 29	85
850 010	313	860 164	64	874 00 73	156	874 10 30	85
850 101	312	874 00 00	156	874 00 74	157	874 10 31	85
850 102	312	874 00 01	156	874 00 76	157	874 10 32	85
850 103	312	874 00 02	63	874 00 78	156	874 10 33	85
850 111	312	874 00 03	62	874 00 79	156	874 10 34	85
850 112	313	874 00 04	63	874 00 80	157	874 10 35	85
850 113	313	874 00 05	62	874 00 82	157	874 10 36	85
850 114	65	874 00 06	156	874 00 84	156	874 10 37	85
850 115	313	874 00 07	156	874 00 85	156	874 10 44	84
850 116	65	874 00 08	63	874 00 86	157	874 10 45	84
850 117	65	874 00 09	62	874 00 88	157	874 10 46	84
850 121	313	874 00 10	63	874 01 22	63	874 10 47	84
850 132	312	874 00 11	62	874 01 23	63	874 10 48	84
850 136	312	874 00 12	156	874 01 24	63	874 10 49	84
850 137	313	874 00 13	156	874 01 25	63	874 10 50	84
850 141	312	874 00 14	63	874 01 26	63	874 10 51	84
850 142	312	874 00 15	62	874 01 27	63	874 10 60	84
850 143	313	874 00 16	63	874 01 28	63	874 10 61	84
850 144	309	874 00 17	62	874 01 29	63	874 10 62	84
85 10 01	61	874 00 18	62	874 01 30	63	874 10 63	84
85 10 03	61	874 00 19	62	874 01 31	63	874 10 64	84
851 100A	310	874 00 20	63	874 01 32	63	874 10 65	84
851 100B	310	874 00 21	62	874 01 33	157	874 10 66	84
851 100D	310	874 00 22	63	874 01 34	157	874 10 67	84
851 101A	311	874 00 23	62	874 01 35	157	874 10 68	84
851 101B	311	874 00 24	62	874 01 36	157	874 10 69	84
851 101D	311	874 00 25	62	874 01 41	63	874 10 70	84
851 102A	311	874 00 26	63	874 01 42	63	874 10 71	84
851 102B	311	874 00 27	62	874 01 43	63	874 10 72	84
851 102D	311	874 00 28	63	874 01 58	63	874 10 73	84
851 150A	310	874 00 29	62	874 01 59	63	874 10 74	84
851 150B	310	874 00 30	62	874 01 60	63	874 10 75	84
851 150D	310	874 00 31	62	874 01 75	88	874 20 00	153
851 151A	311	874 00 32	63	874 01 76	88	874 20 01	153
851 151B	311	874 00 34	63	874 01 77	88	874 20 02	153

Art. no.	Page	Art. no.	Page	Art. no.	Page	Art. no.	Page
874 20 03	153	874 30 47	150	915 882A	385	93 002.01/MS	338
874 20 04	153	874 30 48	150	915 882B	385	93 002.01/PVS	336
874 20 05	153	874 40 00	166	915 882D	385	93 002.02	346
874 20 06	153	874 40 01	166	915 883	361	93 002.02/D	344
874 20 07	153	874 40 02	166	915 883A	385	93 002.02/DS	342
874 20 08	153	874 40 03	166	915 883B	385	93 002.02/DSP	340
874 20 09	153	874 40 04	166	915 883D	385	93 002.02/MS	338
874 20 10	153	874 40 05	166	915 884	361	93 002.02/PVS	336
874 20 11	153	874 40 06	166	915 884A	385	93 002.11	346
874 20 12	152	874 40 07	166	915 884B	385	93 002.11/D	344
874 20 13	152	874 40 10	165	915 884D	385	93 002.12	346
874 20 14	152	874 40 12	165	916 601	363	93 002.12/D	344
874 20 15	152	874 40 14	165	917 413	363	93 002.120B-DL	375
874 20 16	152	874 40 20	165	917 414	363	93 002.120B-DR	375
874 20 17	152	874 40 22	165	917 419.00	382	93 002.120D-DL	375
874 20 18	152	874 40 24	165	917 419.50	382	93 002.120D-DR	375
874 20 19	152	874 40 26	165	917 420.00	382	93 002.21	346
874 20 20	152	874 40 30	165	917 420.50	382	93 002.21/D	344
874 20 21	152	874 40 32	165	917 421	382	93 002.22	346
874 20 22	152	874 40 34	165	917 422B	382	93 002.22/D	344
874 20 23	152	878 711	155	917 422D	382	93 002.31	346
874 30 04	151	878 721	155	917 460	384	93 002.31/D	344
874 30 05	151	879 711	155	917 803	399	93 002.32	346
874 30 07	151	879 721	155	917 804	399	93 002.32/D	344
874 30 09	151	88 10 05	60	917 805	399	93 002.80B-DL	375
874 30 10	151	88 10 05-DN 150	60	917 808	399	93 002.80B-DR	375
874 30 12	151	88 15 05	60	917 809	399	93 002.80D-DL	375
874 30 14	149	88 15 05-DN 150	60	917 821	362	93 002.80D-DR	375
874 30 15	149	88 20 05	60	917 822	398	93 002./120B	377
874 30 16	149	88 20 05-DN 150	60	917 823	362	93 002./120B-DSP-TS	373
874 30 17	149	88 25 05	60	917 826	398	93 002./120B-PVS-TS	372
874 30 18	149	88 25 05-DN 150	60	917 828	398	93 002./120D	377
874 30 19	149	88 30 05	60	917 830	398	93 002./120D-DSP-TS	373
874 30 20	150	88 30 05-DN 150	60	917 861	398	93 002./120D-PVS-TS	372
874 30 21	150			917 862	398	93 002./170B-DSP-TS	373
874 30 22	150	9		917 863	398	93 002./170B-PVS-TS	372
874 30 23	150	913 109	363	917 871	362	93 002./170D-DSP-TS	373
874 30 24	150	913 110	369	917 872	362	93 002./170D-PVS-TS	372
874 30 25	150	915 10 10B	384	917 873	362	93 002./80B	377
874 30 26	150	915 10 10D	384	919 010	361	93 002./80D	377
874 30 27	150	915 10 15B	384	93 001	359	93 002-D1-R2-TS	360
874 30 28	150			93 001/120B	377	93 002-R	359
874 30 29	150	915 10 15D	384	93 001/120B-DSP-TS	373	93 002-R2-TS	360
874 30 30	150	915 10 20B	384	93 001/120B-PVS-TS	372	93 003.00/D1-R	359
874 30 31	150	915 10 20D	384	93 001/120D	377	93 003.01	346
874 30 32	150	915 402	385				
874 30 33	150	915 595	65	93 001/120D-DSP-TS	373	93 003.01/D	344
874 30 34	150			93 001/120D-PVS-TS	372	93 003.01/DS	342
874 30 35	147	915 700-100	361	93 001/170B-DSP-TS	373	93 003.01/DSP	340
874 30 36	147	915 700-150	361	93 001/170B-PVS-TS	372	93 003.01/MS	338
874 30 37	147	915 700-200	361	93 001/170D-DSP-TS	373	93 003.01/PVS	336
874 30 38	147	915 800	362				
874 30 39	147	915 863-IS	361	93 001/170D-PVS-TS	372	93 003.02	346
874 30 40	147			93 001/80B	377	93 003.02/D	344
874 30 41	147	915 870	361	93 001/80D	377	93 003.02/DS	342
874 30 42	147	915 871	361	93 001-D1-R2-TS	360	93 003.02/DSP	340
874 30 43	147	915 880A	384	93 001-R2-TS	360	93 003.02/MS	338
874 30 44	147	915 880B	384				
874 30 45	147	915 880D	384	93 002.00/D1-R	359	93 003.02/PVS	336
874 30 46	147			93 002.01	346	93 003.11	346
		915 881A	385	93 002.01/D	344	93 003.11/D	344
		915 881B	385	93 002.01/DS	342	93 003.12	346
		915 881D	385	93 002.01/DSP	340	93 003.12/D	344

Art. no.	Page	Art. no.	Page	Art. no.	Page	Art. no.	Page
93 003.21	346	93 007.01/D	344	93 010.22/D	344	93 030-06-PVS	337
93 003.21/D	344	93 007.01/DS	342	93 010.31	346	93 035.01	347
93 003.22	346	93 007.01/DSP	340	93 010.31/D	344	93 035.01/D	345
93 003.22/D	344	93 007.01/MS	338	93 010.32	346	93 035.01/DS	343
93 003.31	346	93 007.01/PVS	336	93 010.32/D	344	93 035.01/DSP	341
93 003.31/D	344	93 007.02	346	93 010/120B	378	93 035.01/MS	339
93 003.32	346	93 007.02/D	344	93 010/120B-DSP-TS	373	93 035.01/PVS	337
93 003.32/D	344	93 007.02/DS	342	93 010/120B-PVS-TS	372	93 040.01	347
93 003-D1-R2-TS	360	93 007.02/DSP	340	93 010/120D	378	93 040.01/D	345
93 003-R	359	93 007.02/MS	338	93 010/120D-DSP-TS	373	93 040.01/DS	343
93 003-R2-TS	360	93 007.02/PVS	336	93 010/120D-PVS-TS	372	93 040.01/DSP	341
93 004.00/D1-R	359	93 007.11	346	93 010/170B	378	93 040.01/MS	339
93 004.01	346	93 007.11/D	344	93 010/170B-DSP-TS	373	93 040.01/PVS	337
93 004.01/D	344	93 007.12	346	93 010/170B-PVS-TS	372	93 050.01	347
93 004.01/DS	342	93 007.12/D	344	93 010/170D	378	93 050.01/D	345
93 004.01/DSP	340	93 007.21	346	93 010/170D-DSP-TS	373	93 050.01/DS	343
93 004.01/MS	338	93 007.21/D	344	93 010/170D-PVS-TS	372	93 050.01/DSP	341
93 004.01/PVS	336	93 007.22	346	93 015.05	353	93 050.01/MS	339
93 004.02	346	93 007.22/D	344	93 015.05/D	352	93 050.01/PVS	337
93 004.02/D	344	93 007.31	346	93 015.05/DS	351	93 070.00US	369
93 004.02/DS	342	93 007.31/D	344	93 015.05/DSP	350	93 925/120B	378
93 004.02/DSP	340	93 007.32	346	93 015.05/MS	349	93 925/120D	378
93 004.02/MS	338	93 007.32/D	344	93 015.05/PVS	348	93 925/170B	378
93 004.02/PVS	336	93 007/120B	378	93 015/120B	378	93 925/170D	378
93 004.11	346	93 007/120B-DSP-TS	373	93 015/120D	378	93 930/120B	378
93 004.11/D	344	93 007/120B-PVS-TS	372	93 015/170B	378	93 930/120D	378
93 004.12	346	93 007/120D	378	93 015/170D	378	93 930/170B	378
93 004.12/D	344	93 007/120D-DSP-TS	373	93 015-06	347	93 930/170D	378
93 004.120B-DL	375	93 007/120D-PVS-TS	372	93 015-06-D	345	93 935/120B	378
93 004.120B-DR	375	93 007/170B	378	93 015-06-DS	343	93 935/120D	378
93 004.120D-DL	375	93 007/170B-DSP-TS	373	93 015-06-DSP	341	93 935/170B	378
93 004.120D-DR	375	93 007/170B-PVS-TS	372	93 015-06-MS	339	93 935/170D	378
93 004.21	346	93 007/170D	378	93 015-06-PVS	337	94 002.10	357
93 004.21/D	344	93 007/170D-DSP-TS	373	93 020.05	353	94 002.10DL	356
93 004.22	346	93 007/170D-PVS-TS	372	93 020.05/D	352	94 002.10DR	356
93 004.22/D	344	93 010.01	346	93 020.05/DS	351	94 002.12DL	356
93 004.31	346	93 010.01/D	344	93 020.05/DSP	350	94 002.12DR	356
93 004.31/D	344	93 010.01/DS	342	93 020.05/MS	349	94 002.12L	357
93 004.32	346	93 010.01/DSP	340	93 020.05/PVS	348	94 002.12R	357
93 004.32/D	344	93 010.01/MS	338	93 020/120B	378	94 002.21DL	356
93 004.80B-DL	375	93 010.01/PVS	336	93 020/120D	378	94 002.21DR	356
93 004.80B-DR	375	93 010.02	346	93 020/170B	378	94 002.21L	357
93 004.80D-DL	375	93 010.02/D	344	93 020/170D	378	94 002.21R	357
93 004.80D-DR	375	93 010.02/DS	342	93 020-06	347	94 002.32DL	356
93 004/120B	377	93 010.02/DSP	340	93 020-06-D	345	94 002.32DR	356
93 004/120B-DSP-TS	373	93 010.02/MS	338	93 020-06-DS	343	94 002.32L	357
93 004/120B-PVS-TS	372	93 010.02/PVS	336	93 020-06-DSP	341	94 002.32R	357
93 004/120D	377	93 010.05	353	93 020-06-MS	339	94 004.10	357
93 004/120D-DSP-TS	373	93 010.05/D	352	93 020-06-PVS	337	94 004.10DL	356
93 004/120D-PVS-TS	372	93 010.05/DS	351	93 025-06	347	94 004.10DR	356
93 004/170B-DSP-TS	373	93 010.05/DSP	350	93 025-06-D	345	94 004.12DL	356
93 004/170B-PVS-TS	372	93 010.05/MS	349	93 025-06-DS	343	94 004.12DR	356
93 004/170D-DSP-TS	373	93 010.05/PVS	348	93 025-06-DSP	341	94 004.12L	357
93 004/170D-PVS-TS	372	93 010.11	346	93 025-06-MS	339	94 004.12R	357
93 004/80B	377	93 010.11/D	344	93 025-06-PVS	337	94 004.21DL	356
93 004/80D	377	93 010.12	346	93 030-06	347	94 004.21DR	356
93 004-D1-R2-TS	360	93 010.12/D	344	93 030-06-D	345	94 004.21L	357
93 004-R	359	93 010.21	346	93 030-06-DS	343	94 004.21R	357
93 004-R2-TS	360	93 010.21/D	344	93 030-06-DSP	341	94 004.32DL	356
93 007.01	346	93 010.22	346	93 030-06-MS	339	94 004.32DR	356

Art. no.	Page	Art. no.	Page	Art. no.	Page	Art. no.	Page
94 004.32L	357	95 030-120B	376	95 125-120B	376	97 723	92
94 004.32R	357	95 030-120B-DL	374	95 125-120B-DL	374	97 724	92
94 007.10	357	95 030-120B-DR	374	95 125-120B-DR	374	98 201/00B	379
94 007.10DL	356	95 030-120D	376	95 125-120D	376	98 201/00D	379
94 007.10DR	356	95 030-120D-DL	374	95 125-120D-DL	374	98 202/00B	379
94 007.12DL	356	95 030-120D-DR	374	95 125-120D-DR	374	98 202/00D	379
94 007.12DR	356	95 030-170B	376	95 125-170B	376	98 204/00B	379
94 007.12L	357	95 030-170B-DL	374	95 125-170B-DL	374	98 204/00D	379
94 007.12R	357	95 030-170B-DR	374	95 125-170B-DR	374	99 102.02	366
94 007.21DL	356	95 030-170D	376	95 125-170D	376	99 104.02	366
94 007.21DR	356	95 030-170D-DL	374	95 125-170D-DL	374	99 107.02	366
94 007.21L	357	95 030-170D-DR	374	95 125-170D-DR	374	99 110.02	
94 007.21R	357	95 040-120B	376	96 004.120B	381	99 116.02	367
94 007.32DL	356	95 040-120B-DL	374	96 004.120B-DL	381	99 120.02	367
94 007.32DR	356	95 040-120B-DR	374	96 004.120B-DR	381	99 126.02	367
94 007.32L	357	95 040-120D	376	96 004.120D	381	99 403.10B EX	395
94 007.32R	357	95 040-120D-DL	374	96 004.120D-DL	381	99 403.10D EX	395
94 010.10	357	95 040-120D-DR	374	96 004.120D-DR	381	99 503.10B EX	394
94 010.10DL	356	95 040-170B	376	96 004.80B	381	99 503.10D EX	394
94 010.10DR	356	95 040-170B-DL	374	96 004.80B-DL	381	99 601.002B	396
94 010.12DL	356	95 040-170B-DR	374	96 004.80B-DR	381	99 601.016B	396
94 010.12DR	356	95 040-170D	376	96 004.80D	381	99 601.016D	396
94 010.12L	357	95 040-170D-DL	374	96 004.80D-DL	381	99 601.041D	396
94 010.12R	357	95 040-170D-DR	374	96 004.80D-DR	381	99 606.30B EX	395
94 010.21DL	356	95 070-120B	376	96 007.120B	381	99 606.30D EX	395
94 010.21DR	356	95 070-120B-DL	374	96 007.120B-DL	381	99 606.80B EX	395
94 010.21L	357	95 070-120B-DR	374	96 007.120B-DR	381	99 606.80D EX	395
94 010.21R	357	95 070-120D	376	96 007.120D	381	99 610.15B EX	395
94 010.32DL	356	95 070-120D-DL	374	96 007.120D-DL	381	99 610.15D EX	395
94 010.32DR	356	95 070-120D-DR	374	96 007.120D-DR	381	99 610.30B EX	395
94 010.32L	357	95 070-170B	376	96 007.80B	381	99 610.30D EX	395
94 010.32R	357	95 070-170B-DL	374	96 007.80B-DL	381	99 610.80B EX	395
94 200.01	407	95 070-170B-DR	374	96 007.80B-DR	381	99 610.80D EX	395
94 201.01	407	95 070-170D	376	96 007.80D	381	99 615.80B EX	395
94 202.01	407	95 070-170D-DL	374	96 007.80D-DL	381	99 615.80D EX	395
94 203.01	407	95 070-170D-DR	374	96 007.80D-DR	381	99 620.80B EX	395
95 010-120B	376	95 085-120B	376	96 010.120B	381	99 620.80D EX	395
95 010-120B-DL	374	95 085-120B-DL	374	96 010.120B-DL	381	99 703.04B	393
95 010-120B-DR	374	95 085-120B-DR	374	96 010.120B-DR	381	99 703.04D	393
95 010-120D	376	95 085-120D	376	96 010.120D	381	99 703.10B	393
95 010-120D-DL	374	95 085-120D-DL	374	96 010.120D-DL	381	99 703.10D	393
95 010-120D-DR	374	95 085-120D-DR	374	96 010.120D-DR	381	99 703.10F	391
95 010-170B	376	95 085-170B	376	96 010.80B	381	99 706.02B	393
95 010-170B-DL	374	95 085-170B-DL	374	96 010.80B-DL	381	99 706.02D	393
95 010-170B-DR	374	95 085-170B-DR	374	96 010.80B-DR	381	99 706.06B	393
95 010-170D	376	95 085-170D	376	96 010.80D	381	99 706.06D	393
95 010-170D-DL	374	95 085-170D-DL	374	96 010.80D-DL	381	99 706.06F	
95 010-170D-DR	374	95 085-170D-DR	374	96 010.80D-DR	381	99 706.10B	393
95 020-120B	376	95 100-120B	376	97 201/000	402	99 706.10D	393
95 020-120B-DL	374	95 100-120B-DL	374	97 201/00A	403	99 706.18B	393
95 020-120B-DR	374	95 100-120B-DR	374	97 201/00B	403	99 706.18D	393
95 020-120D	376	95 100-120D	376	97 201/00D	403	99 706.30B EX	394
95 020-120D-DL	374	95 100-120D-DL	374	97 202/000	402	99 706.30D EX	394
95 020-120D-DR	374	95 100-120D-DR	374	97 202/00A	403	99 706.80B EX	394
95 020-170B	376	95 100-170B	376	97 202/00B	403	99 706.80D EX	394
95 020-170B-DL	374	95 100-170B-DL	374	97 202/00D	403	99 710.15B EX	394
95 020-170B-DR	374	95 100-170B-DR	374	97 713	92	99 710.15D EX	394
95 020-170D	376	95 100-170D	376	97 714	92	99 710.30B EX	394
95 020-170D-DL	374	95 100-170D-DL	374	97 715	92	99 710.30D EX	394
95 020-170D-DR	374	95 100-170D-DR	374	97 716	92	99 710.80B EX	394

Art. no.	Page
99 710.80D EX	394
99 715.80B EX	394
99 715.80D EX	394
99 815	391
99 815S	391

99 830	391
99 830S	391

A

AQUALI1000F_D	166
AQUALI1000F_DS	166
AQUALI1000F_T	166
AQUALI1000F_TS	166

G

GTF1400-M	165
GTF1600-M	165
GTF2600-M	165
GTF4000-M	165
GTK1300-M	165

GTK2600-M	165
GTK3700-M	165

S

STZ1300-M	165
STZ2500-M	165
STZ3700-M	165

KESSEL AG Standard Conditions of Sale (SCS) – International

1. Scope of application, form

- (1) The present Standard Conditions of Sale (SCS) apply to all our business relations with our customers ("Purchaser"). The SCS apply only provided the Purchaser is an entrepreneur (§14 of the German Civil Code (BGB)), a public-law legal entity or public-law special assets.
- (2) The SCS apply particularly to contracts for the sale and/or delivery of movable objects ("Products") as well as the sale of goods, software and technology ("Goods"), irrespective of whether we manufacture the Products/Goods ourselves or purchase them from suppliers (§§ 433, 651 BGB). Unless anything different has been agreed, the version of the SCS which was applicable at the time of the Purchaser's order or at least as last communicated to him in text form will apply as a framework agreement, if the customer has not lodged an objection to them within two months. The SCS also in the case of similar future contracts and without our having to refer to them again in each individual case. As a matter of principle, we do not render any planning services for the customer.
- (3) Only our SCS apply. The customer's terms and conditions of business do not apply, even if we do not issue any separate objection to their validity. Differing or contradictory terms and conditions apply only if they have been accepted by us in writing.
- (4) Individual agreements made with the Purchaser in a particular case (including side-agreements, additions and amendments) will in any event have precedence over these SCS. Subject to proof to the contrary, the content of such agreements will be governed by a written contract or our written confirmation. The parties agree that these SCS conditions fully reflect the agreements of the contracting parties and that no further agreements exist beyond these SCS.
- (5) Legally material declarations and notices by the Purchaser with regard to the contract (e.g. setting of a deadline, request for return, report of defects, rescission or a price reduction) must be submitted in writing, i.e. in written or text form (e.g. letter, e-mail, fax). This will not affect legal requirements regarding form and additional evidence, particularly in the event of doubts on the legitimacy of the party making the declaration.
- (6) Reference to the application of provisions of the law are only intended for purposes of clarification. Thus, even without such clarification, the provisions of the law will apply unless they are directly amended or expressly excluded in these SCS. § 312i paragraph 1 No. 1-3 BGB do not apply.

2. Conclusion of a contract

- (1) Our quotations are subject to change and not binding. This will also be the case should we have provided the Purchaser with catalogues, technical documentation (e.g. drawing, plans, calculations, estimates, reference to DIN norms), other product descriptions or documents – also in electronic form – to which we reserve rights of title and copyright.
- (2) The Purchaser's order for Products is considered a binding offer to conclude a contract. Unless the order provides for anything different, we are entitled to accept this offer to conclude a contract within four weeks of having received the offer.
- (3) The offer may be accepted either in writing (e.g. by way of an order confirmation) or through delivery of the Products to the Purchaser.

3. Reservation regarding matters related to the German Foreign Trade Law

The contract is subject to the reservation that its fulfilment is not subject to any hindrances due to the domestic or international provisions of the Foreign Trade Law or contrary to any embargos and/or other sanctions. Our Goods may be subject to restrictions under the Foreign Trade Law. These are to be understood to include legal prohibitions and/or obligations to obtain permits. Should a Product be purchased that is subject to the requirement that approval is obtained, it will be clarified with the Purchase in each individual case how the goods are to be shipped and whether a contract may be concluded at all. A restriction in terms of the Foreign Trade Law may be related inter alia to the final destination and intended use of the Products. Should Products supplied by us be forwarded to a third party at home or in a foreign country, the Purchaser is required to comply with the applicable provisions of domestic and international foreign trade law. If necessary, the Purchaser is required, immediately on being requested to do so, to provide us with all information and documents required by the responsible authority for approval in accordance with the Foreign Trade Law concerning the ultimate recipient, final destination and intended use of the Products we supply as well as any restrictions in terms of foreign trade law in this regard. Any amendments and errors reserved.

4. Delivery period and delivery delays

- (1) The delivery period will be agreed individually or stated by us on accepting the order. Should this not be the case, the delivery period is approximately four weeks after transfer to the freight forwarder / carrier. With regard to the particularities during the Covid-19 pandemic, please see section 6.
- (2) Should we be unable to meet binding delivery dates for reasons for which we are not responsible (service not available), we will inform the Purchaser of this fact immediately and simultaneously give notification the probable new delivery period. Should the service also not be available within the new delivery period, we are entitled to rescind all or part of the contract; should the Provider have already paid for the service, we will reimburse this immediately. Non-delivery of the service within the meaning of the above is particularly the case in which our supplier does not deliver to us on time, should we have concluded a parallel covering order, should neither we or our supplier be at fault or should we not be required to procure the Products in the particular case. We assume no procurement guarantee.
- (3) We will be in arrears with the delivery should we be responsible for the delay in service, whereby our degree of blame in accordance with § 9 of these SCS is limited to deliberate intent and gross negligence. As a matter of principle, a reminder by the Purchaser is required unless the reminder is rendered unnecessary by an agreement for a delivery period in accordance with paragraph 1. Should we fall into arrears with the delivery, the Purchaser may demand a lump-sum amount as compensation for its damages due to the delay. The lump-sum compensation amount of 0.5% of the net price (delivery value) for every complete week of arrears, subject however to a maximum of 5% of the delivery value of the Goods delivered late. We reserve the right to prove that the Purchaser has not incurred any damage or has incurred considerably lower damages than the above lump-sum amount.
- (4) The Purchaser's rights in accordance with § 8 of these SCS and our legal rights, particularly in the event of an exclusion of the obligation to perform (e.g. due to impossibility or that performance and/or subsequent fulfilment are unreasonable) are not affected.

5. Force majeure

- (1) In the event of force majeure, we will not be in default in respect of the obligations affected by force majeure and the obligation to perform or fulfil these obligations punctually will be suspended automatically for the period of the force majeure.

- (2) Force majeure relates to events or circumstances of all any type that
 - (a) are beyond the reasonable control of the party claiming force majeure;
 - (b) were not effective or reasonably foreseeable when the contract was concluded;
 - (c) do not constitute acts, events or conditions the risks or consequences of which were expressly assumed by the affected party, and
 - (d) despite the exercise of due care and diligence by the affected party claiming force majeure (or by third parties under the control of the affected party, including subcontractors), cannot be rendered harmless, remedied, averted, offset, negotiated or otherwise overcome.
- (3) If we are prevented from fulfilling a contractual obligation by force majeure, we will inform the Purchaser about the event or the circumstances constituting force majeure, naming the obligations we are prevented from fulfilling. Once this notification has been provided, we will be released from the requirement to fulfil these obligations as long as the case of force majeure prevents us from doing so.
- (4) In the event of a force majeure event, we will not be liable for any resulting loss or damage incurred by the Purchaser. In particular, we will not be liable for any loss or damage incurred by the Purchaser due to delays in deliveries or non-deliveries.

6. Delivery, transfer of risk, delay in acceptance

- (1) The delivery will be made solely in the packing units stated. The delivery is carried out from the warehouse, which is also the place of fulfilment for the delivery and of any subsequent fulfilment. At the request and expense of the Purchaser, the Goods may be delivered to a different destination (sales shipment). Unless anything different has been agreed, we are entitled to determine ourselves the method of shipment (particularly freight forwarder, routing, packaging). Surcharges for freight sent as an urgent or express shipment will be paid by the Purchaser. The Purchaser is required to report transport damage to the freight forwarder/service provider as soon as the shipment is received and to note any damage in writing in the shipment documents.
- (2) The risk of accidental destruction and accidental deterioration will pass to the Purchaser at the latest upon delivery. In the case of sales shipments however the risk of accidental destruction and accidental deterioration of the Products as well as the risk of delay will pass already on delivery of the Products to the freight forwarder, transporter or any other person or institution appointed to carry out the delivery. Only insofar as formal acceptance have been expressly agreed within the meaning of § 433 paragraph 2 BGB will this determine the transfer of risk. Should the Purchaser be in arrears in accepting the Goods, it is irrelevant whether the Goods are handed over or subject to formal acceptance.
- (3) Should the Purchaser be in arrears in accepting the Goods, fail to fulfil an obligation to cooperate or should our delivery be delayed for other reasons for which the Purchaser is responsible, we are entitled to demand compensation for damage incurred thereby, including additional expenses (e.g. storage costs). For this purpose, we charge a lump-sum amount of 1.0% of the net value of the Goods for each complete month as compensation, subject however to a maximum of 5 % of the net value of the Goods, beginning on the delivery date or, in the absence of the delivery date, with the notification that the Goods are ready to be delivered. This does not affect proof of higher damage and our legal rights (particularly compensation for additional expenses, adequate compensation, termination); the lump-sum amount is however to be deducted from additional financial claims. The Purchaser is entitled to prove that we have not incurred any damage or considerably lower damages than the above lump-sum amount.

7. Prices and payment conditions

- (1) Unless anything different is agreed in the particular case, our current ex warehouse price list at the time the contract is concluded plus the VAT stipulated by law will apply.
- (2) In the case of a sales shipment (§ 5 paragraph 1), the Purchaser will pay the costs of transport from the warehouse as well as any transport insurance requested by the Purchaser.
- (3) We charge 10.00 € minimum quality surcharge on deliveries of less than 150.00 € net goods value.
- (4) A third-party delivery surcharge of 8% of the net goods value will be charged on orders that are not delivered to the Purchaser's warehouse.
- (5) The purchase price is due and payable immediately.
- (6) In justified cases, we are entitled to make the respective delivery, at our discretion, only in return for full advance payment of the respective purchase price or adequate collateral. We will state the reasons for requiring advance payment or for a request for collateral. Advance payment or collateral will be due immediately upon receipt of the statement by the customer. A justified case will exist in particular if
 - (a) the customer is in arrears with a due payment at an amount that is more than negligible and has not paid it or has not paid in full even upon express request,
 - (b) the customer has been in default with a due payment twice in twelve months,
 - (c) enforcement measures have been initiated against the customer in respect of monetary claims (§§ 803 - 882a ZPO (Code of Civil Procedure)),
 - (d) there is a concern, based on overall circumstances to be assessed, that the customer is likely to operate in a manner that breaches the contract,
 - (e) a previous contractual relationship with the customer has been effectively terminated. If the customer does not make an advance payment, provides it late or not in full, we are entitled to terminate the contractual relationship for cause and to dissolve the business relationship. The same applies to the provision of collateral.
- (7) If we elect provision of collateral, it must be a bank guarantee. The guarantor must be a credit institution or credit insurer licensed in the European Community (Fitch credit rating index or equivalent, at least A). The declaration of surety must be in writing, for an unlimited period and must waive the defence of failure to pursue remedies. The right of deposit must be excluded. Furthermore, the guarantor must state that the place of jurisdiction is our registered office and that the guarantee claim will not be time-barred before the secured principal claim. We will return the collateral when the grounds for the collateral ceases to apply.
- (8) The Purchaser will be in arrears 30 days after the payment deadline has expired. The interest rate on arrears stipulated by law will be charged on the purchase price whilst payment is in arrears. We reserve the right to claim additional damages on account of payment arrears. In relations with entrepreneurs, our right to claim the commercial interest rate after the due date (§ 353 of the Commercial Code (HGB)) is not affected.
- (9) Should it become clear after the contract has been concluded (e.g. though an application for the initiation of insolvency proceedings), that our claim to the purchase price is endangered due to lack of ability on the part of the Purchaser to perform, we will be entitled to refuse performance in accordance with the provisions of the law and to rescind the contract (§ 321 BGB). In the case of contracts for the manufacture of products which are not inter-changeable

(individual constructions), we may declare rescission immediately; this will not affect the provisions of the law relating to the necessity of setting a grace period.

8. Reservation of title

- (1) We reserve title to the respective goods sold until our claims under the purchase contract (secured claims) are paid for in full.
- (2) Goods subject to reservation of title may neither be mortgaged to third parties nor have title transferred by way of collateral until the secured claims are paid for in full. The Purchaser is required to notify us immediately in writing should insolvency proceedings be applied for or should third parties seize goods belonging to us (e.g. attachments).
- (3) In the event of behaviour by the Purchaser in breach of contract, particularly non-payment of the purchase price once due, we are entitled, in accordance with the provisions of the law to rescind the contract and/or to demand the return of the Goods on account of reservation of title.
- (4) The Purchaser is authorised until further notice in accordance with (c) below to continue to sell and/or to process reserved goods as part of its regular business activity. In this case, the following provisions will apply additionally.
- (a) The reservation of title includes the full value of the products resulting from processing, mixing or combining our goods, whereby we are deemed to be the manufacturer. Should, in the event of processing, mixing or combining with goods belonging to third parties, these third parties retain their rights of ownership, we will acquire co-ownership in proportion to the invoice value of the processed, mixed or combined goods. Otherwise, the same will apply to the resulting product as applies to Goods delivered subject to reservation of title.
- (b) The Purchaser cedes to us with immediate effect the receivables due from third parties created as a result of the re-sale of the Goods or the Products, at the level of our ownership or any co-ownership we might have in accordance with the previous paragraph, as security. We accept the cession. The Purchaser's obligations referred to in paragraph 2 also apply with respect to the ceded receivables.
- (c) In addition to us, the Purchaser is entitled to collect the receivables. We undertake not to collect the receivables as long as the Purchaser fulfils its payment obligations to us, as long as there is no deficiency in its ability to perform and we do not enforce the reservation of title by exercising a right in accordance with paragraph 3. Should this be the case, however, we may demand that the Purchaser inform us of the receivables ceded and their debtors as well as all information required to collect the receivables, hands over the relevant documents and notifies the debtors (third parties) of the cession. Moreover, in this case we are entitled to rescind the Purchaser's authority to continue to dispose of and to process the Goods subject to reservation of title after setting of deadline. We are also entitled to rescind it in the event of an application for insolvency and the opening of insolvency proceedings.
- (d) Should the realisable value of the collateral exceed our claims by more than 10%, we will, at the Purchaser's request, release collateral of our choice.

9. Return of goods

In the case of certain articles in our standard program it is possible, after our individual examination and explicit agreement, to return fault-free goods for a service fee. The customer must send us his return request in advance in writing or in text form. A return of goods without our prior approval is not possible.

10. Purchaser's warranty claims

- (1) Unless anything different is agreed below, the Purchaser's rights in the event of quality and legal defects will be governed by the provisions of the law. In any event, the special provisions of the law relating to the final delivery of unprocessed Goods to a consumer are not affected, even should this consumer have further processed the goods (supplier's recourse in accordance with §§ 478 BGB). Claims derived from supplier's recourse are excluded should the defective goods have been further processed by the Purchaser or some other entrepreneur, e.g. as a result of installation in another product.
- (2) Liability for defects is based above all on the agreement made on the nature of the Goods. All product descriptions which are the object of the individual contract will be considered an agreement on the nature of the goods.
- (3) Should the nature of the goods not have been agreed, the provision, whether a defect is present or not (§ 434 paragraph 1 page 2 and 3 BGB) will be judged by the provision of the law. We assume no liability for statements made by third parties (e.g. advertising claims).
- (4) Warranty claims by the Purchaser are conditional on it having fulfilled its legal obligations to examine the Goods and to report defects (§§ 377, 381 HGB). This also includes a visual check for transport damage and an immediate report to the freight forwarder/service provider in accordance with section 5 paragraph 1 of these SCS. Should a defect be identified at the time of the delivery, the examination or at some time subsequently, this must be notified to us immediately in writing. In any event, obvious defects must be reported in writing within five days of the delivery and defects not identified at the time of the examination must be reported in writing within the same period of time from when the defect is discovered. Should the Purchaser fail to carry out an examination correctly and/or fail to report defects correctly, our liability for the defect not reported or not reported on time or properly is excluded in accordance with the provisions of the law.
- (5) The warranty will not apply if the customer modifies the supplied item or has it modified by a third party without our approval and rectification of the defect is thereby rendered impossible or unreasonably difficult. In any case, the customer must bear the additional costs of the rectification of defects incurred on account of the modification.
- (6) Should the object delivered be defective, we may initially choose whether we provide subsequent fulfilment by eliminating the defect (rectification) or by the delivery of a defect-free object (replacement shipment). Our right to refuse subsequent fulfilment in accordance with the conditions provided for in law is not affected.
- (7) We are entitled to make the required subsequent fulfilment dependent on whether the Purchaser has paid the purchase price due. The Purchaser is however entitled to withhold a reasonable part of the purchase price proportionate to the defect. Reasonable is generally double the costs required in order to remedy the defect.
- (8) The Purchaser is required to grant us the time and opportunity required in order to carry out the subsequent fulfilment due, in particular to hand over the Goods complained of for purposes of examination. In the case of a replacement shipment, the Purchaser is required to return the defective object as required by law. Subsequent fulfilment does not include either dismantling or re-assembling the defective object should we originally not have been required to carry out assembly.
- (9) We will reimburse the expenses required for examination and subsequent fulfilment, particularly the costs of transport, travel, labour and materials as well as, if applicable, those of dismantling and reassembly, in accordance with the requirements of the law, provided a defect is actually present. Otherwise, we may demand from the Purchaser the reimbursement of the costs of the unjustified request that the defect be eliminated (particularly the costs of

examination and transportation), unless the fact that the object was not defective was not evident to the Purchaser.

- (10) Should subsequent fulfilment fail or should a time-limit for subsequent fulfilment to be set by the Purchaser expire without the desired result or be unnecessary in accordance with the provisions of the law, the Purchaser may rescind the contract or reduce the purchase price. Should the defect be only minor however, there is no right to rescind the contract.
- (11) Claims by the Purchaser for compensation or the reimbursement of costs incurred in vain with regard to defects are only admissible in accordance with § 11 and are otherwise excluded.

11. Other liability

- (1) Unless these SCS including the following conditions provide for anything different, we are liable for the infringement of contractual and out-of-court obligations in accordance with the provisions of the law.
- (2) We are liable for compensation – irrespective of the legal reason – in accordance with the law of negligence in cases of deliberate intent and gross negligence. In the event of minor negligence, we are liable, subject to a lesser degree of liability in accordance with the provisions of the law (e.g. duty of care in one's own affairs), only
- (a) for damage due to injury to life, limb or health,
- (b) for damage due to a not inconsiderable infringement of a significant contractual obligation, the fulfilment of which makes the proper implementation of the contract possible at all and on whose compliance the contractual partner normally relies and may rely; in this case, our liability is however limited to compensation for the foreseeable damage typically incurred.
- (3) The limitations of liability referred to paragraph 2 also apply to infringements of obligations in favour of persons for whose negligence we are responsible according to the law. They do not apply should we have fraudulently concealed a defect or assumed a guarantee of the nature of the goods and to claims by the Purchaser in accordance with the German Law on Product Liability.
- (4) The Purchaser may only rescind or terminate the contract on account of an infringement of an obligation that does not constitute a defect should we be responsible for the infringement of the liability. Free right to terminate on the part of the Purchaser is excluded. Otherwise, the conditions and legal consequences provided for in law will apply.

12. Time-limitation

- (1) The Purchaser's claims will become time-expired two years after the final invoice date.
- (2) Building materials and building modules that have been used in the construction of a building in accordance with their normal intended use and which have caused the building to have defects are governed by the provisions of the law.

13. Data processing / data protection

- (1) We record, process and use personal data (e.g. name, delivery address, invoice address, telephone number, tax number etc.) that have become known as part of contractual relations and which are required in order to process orders. We also process third parties' data (final customers/final consumers) transmitted to us by the Purchaser for the purpose of processing as part of the order. For its part, the Purchaser is responsible for processing the data in accordance with data protection within the meaning of the General Data Protection Regulation (GDPR for short) and the German Federal Data Protection Law (BDSG for short) within the meaning of these laws.
- (2) We transmit data obtained as part of the business relationship with the Purchaser to external third parties
- for the purpose of preparing quotations,
 - for order processing and invoicing purposes
 - as part of fulfilling data processing tasks with service partners.
- We oblige external third parties to ensure the confidentiality and security of the data. The volume of data transmitted is established contractually. Provided this is required in order to safeguard legitimate interests, we also transmit data to end customers/end users directly or through a contractual partner within the meaning of article 28 GDPR. In doing this, we ensure that the interests of the Purchaser and of end customers/end users worthy of protection are not impinged. Equally, the Purchaser is required to ensure when processing that the interests of end customers/end users worthy of protection are not impinged and that the provisions of the GDPR and BDSG are complied with. In this regard, the Purchaser will ensure in particular that there is a legal basis in accordance with GDPR und BDSG for processing end customers'/end users' personal data. The Purchaser may ensure this by concluding contracts or by having secured end customer' consent to our further processing of personal data. The Purchaser will for its part also fulfil existing information obligations to its end customers/end users in accordance with GDPR. The Purchaser will inform the end customers /end users in a way that can be proven that their personal data has been forwarded to us in order to carry out the order and for processing purposes.
- (3) We reserve the right to obtain information from commercial information agents or credit insurers with regard to the Purchaser's credit rating for purposes of checking his creditworthiness and to report data to him – limited to cases of processing not according to contract, e.g. application for a dunning letter, with regard to an undisputed claim, enforcement order, sequestration measures. Data will only be transmitted provided that this is necessary in order to safeguard our legitimate interests. Balance sheet data will be handled confidentially and used solely for the purpose of credit checking.
- The Purchaser expressly gives his consent to the data processing described above. With regard to the processing of contractual partners' and final customers' personal data provided to us by the Purchaser for the purpose of carrying out the order, the Purchaser will irrevocably ensure with documentary evidence that the legal basis required for this purpose in accordance with the GDPR and the BDSG exists in our favour.

14. Choice of law and place of jurisdiction

- (1) These SCS and the contractual relationship between ourselves and the Purchaser are subject to the law of the Federal Republic of Germany to the exclusion of international uniformity law, particularly UN purchasing law.
- (2) Should the Purchaser be an entrepreneur within the meaning of the Commercial Code, a public-law legal entity or public-law special assets, the sole – also international – place of jurisdiction for the Purchaser for all disputes arising directly or indirectly from the contractual relationship is our registered office (Lenting) Ingolstadt. The same will apply should the Purchaser be an entrepreneur within the meaning of § 14 BGB. We are however in any event entitled to lodge a claim at the place of performance of the delivery obligation in accordance with these SCS or with an individual agreement having precedence or at the Purchaser's general place of jurisdiction. This will not affect overriding provisions of the law, particularly with respect to exclusive responsibilities.

Last updated: 01.08.2021

Sales Department

Northern Europe and Far East

Tel +49 8456 / 27-310

Eastern Europe

Tel +49 8456 / 27-189

Southern Europe

Tel +49 8456 / 27-257

Western Europe and America

Tel +49 8456 / 27-246

Middle East

Tel +49 8456 / 27-341

Australia and New Zealand

Tel +49 8456 / 27-257

Technical support

Tel +49 8456 / 27-208

+49 8456 / 27-320

info@kessel.com

After sales service

Tel +49 8456 / 27-755

info@kessel.com

The contents of this catalogue and its layout are the property of KESSEL AG and are copyright protected. Any copying of the catalogue or its individual contents is prohibited without the express permission of the owner and is subject to prosecution or civil judgements. All rights reserved.

Rights reserved for technical changes. Issue february 2023.

WEEE-Reg.-Nr. DE 86420036



KESSEL AG

Bahnhofstrasse 31 • 85101 Lenting • Germany

www.kessel.com



Carbon neutral

Print product

ClimatePartner.com/53506-2306-1001

010-773 HI/SE 06/23