



# 6

# Electrical Equipment



INDEX	Page
1- ABS UNDERWATER LIGHTS	94
2- AQUA ABS UNDERWATER LIGHTS	94
3- UNDERWATER "FLAT" LIGHT	95
4- "MINI DICHRO" UNDERWATER LIGHTS	95
5- ABS FOUNTAIN LIGHTS	95
6- STAINLESS STEEL LARGE U/W LIGHT WITH NICHE	96
7- STAINLESS STEEL LARGE FLUSH LIGHT	96
8- STAINLESS STEEL "MINI FLUSH" LIGHT	97
9- STAINLESS STEEL UNDERWATER LIGHT FOR SPA "DECORATIVO"	97
10- AQUA FOUNTAIN LIGHT	98
11- STAINLESS STEEL FOUNTAIN LIGHT	98
12- STAINLESS STEEL HALOGEN LIGHTS	99
13- STAINLESS STEEL ROUND LED LIGHTS	100
14- ULTRA FLAT STAINLESS STEEL ROUND/SQUARE LED LIGHTS	101
15- LED LIGHT "AQUALUXE"	102
16- SPOT LIGHT LED	102
17- UNDERWATER LAMP	103
18- UNDERWATER LED BULBS & REMOTE	103
20- FLEXIBLE CONNECTION CABLE	103
21- ABS CONNECTION BOXES	104
22- STAINLESS STEEL CONNECTION BOX	104
23- CASCADE TRANSFORMER	105
24- LED WALL WASHER LINEAR TUBE LIGHTS	106
25- LED AQUA FOUNTAIN LIGHT	107
26- LED TAPE LIGHT	108
27- INSULATING GEL IP68	109

# Electrical Equipment



## 1- ABS UNDERWATER LIGHTS

- Underwater Light with recess, cable and lamp.
- Made in white UVA resistant ABS plastic capable of withstanding the harsh chemicals often used in a swimming pool.
- Its two screw mechanism ensures the perfect attachment of the spotlight protecting it from falling off or moving when touched by bathers.
- 3/4" recess outlet with gland seal suitable for cable hose threading.
- 300W, 12V AC lamp.
- IP 68 protection rate.

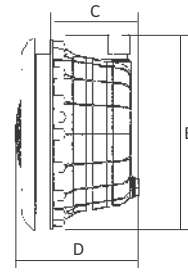
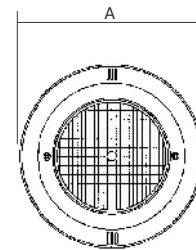
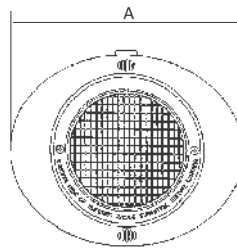

SHAPE	POOL	CODE	DIMENSIONS				SPOT	PACKING	WEIGHT	VOLUME
			A	B	C	D				
○	Concrete	E-101	280	275	130	180	300W - 12V AC	4	12.6	0.069
○		E-102	340	280	130	180	300W - 12V AC	1	3.5	0.020
○	Pre-fabricated	E-103	280	275	130	180	300W - 12V AC	4	14	0.069
○		E-104	340	280	130	180	300W - 12V AC	1	3.5	0.020
○	Liner	E-105	280	275	130	180	300W - 12V AC	4	14	0.069
○		E-106	340	280	130	180	300W - 12V AC	1	3.5	0.020
<b>SSRIM03</b>			Stainless steel AISI316L V4A rim							

## 2- AQUA ABS UNDERWATER LIGHTS



- ABS light PAR56 suitable for both liner and concrete pools
- Supplied with 12V AC lamp (standard 300W and LED are available).
- Kit also contains: light body, light box with connector, power derivation box CEI approved with connector, flexible hose protector.
- 2.5mt panel installation without sandwich gasket.
- Installation kit for the desired kind of pool (Liner, Concrete).
- IP 68 protection rate.

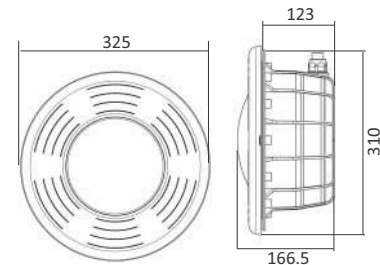

POOL	CODE	DESCRIPTION	SPOT	PACKING	WEIGHT	VOLUME
					kg	m <sup>3</sup>
Concrete	<b>200300002</b>	Par56 under water Halogen light Complete with installation kit*	300W - 12V AC	1	4.5	0.035
Liner	<b>200300001</b>	Par56 under water Halogen light complete with installation kit*	300W - 12V AC	1	4.5	0.035
<b>SSRIM04</b>		Stainless steel AISI316L V4A rim				

### 3- UNDERWATER "FLAT" LIGHT

- Wall light for tile- and mosaic pools, made of UV resistant white ABS.
- 2,5m under water cable HO7RN-F 2 x 1,5 and 1m flexible conduit hose.
- Protection glass, IP-68 protection rate.

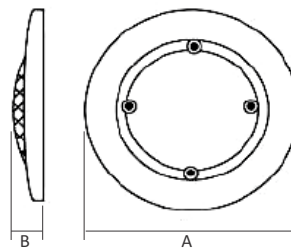

CODE	DESCRIPTION	DIMENSIONS		SPOT	PACKING	WEIGHT	VOLUME
		A	B				
E-108	Standard	291	66	100W - 12V AC	10	12 kg	0.023 m <sup>3</sup>
E-108-C	With 3 color lance	260	66	100W - 12V AC	10	12 kg	0.023 m <sup>3</sup>

### 4- "MINI DICHRO" UNDERWATER LIGHTS

- U/W lights for Polyester/Liner pool or spa, made of UV resistant white ABS.
- Easily disassembled, using the outer side of the frame as a key when the lamp needs replacement.
- IP 68 protection rate.

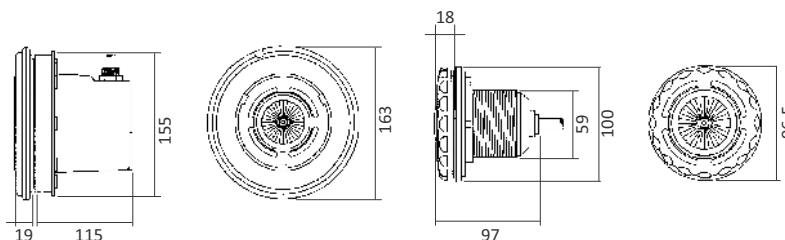

CODE	DESCRIPTION	SPOT	PACKING	WEIGHT	VOLUME
E-112	U/W Halogen Light with niche & cable	50W - 12V AC	1	5.5	0.022
E-113	U/W Halogen Light threaded type with cable	50W - 12V AC	1	3	0.010
SSRIM02	Stainless steel AISI316L V4A face plate				
SSRIM 01	Stainless steel AISI316L V4A face plate				

### 5- ABS FOUNTAIN LIGHTS

- Available in ABS plastic.
- Should always be installed fully submerged in water.
- Can be adjusted to face any direction.
- With 4 meter cable.
- IP 68 protection rate.



CODE	DESCRIPTION	SPOT	PACKING	WEIGHT	VOLUME
E-114	Fountain light with halogen light PAR 56	300W - 12V AC	1	4	0.03



# Electrical Equipment



## 6- STAINLESS STEEL LARGE U/W LIGHT WITH NICHE

- Made completely of AISI-316 stainless-steel.
- With round or conical niche.
- Include 300W, 12V AC bulb, 2.5meter cable and gland.
- Protection IP68.

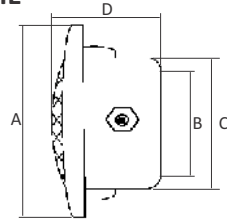

POOL	CODE	NICHE TYPE	DIMENSION				PACKING	WEIGHT kg	VOLUME m <sup>3</sup>
			A	B	C	D			
Concrete	E-133	Conical S.Steel	300	150	280	145	1	4	0.025
	E-134	Round S.STEEL	300	200	222	120	1	4	0.025
	E-135	Round ABS	300	180	210	152	1	4	0.025
Liner	E-135-L	Round ABS	300	180	210	152	1	4	0.025



## 7- STAINLESS STEEL LARGE FLUSH LIGHT

- Made from Stainless Steel AISI-304 for durable use.
- A various selection as quartz halogen or LED series in multi-color changing.
- Patented design uses a mounting hub and bracket instead of a niche .
- Wall hanging fit, easy to install and maintain.
- IP68 waterproof standard.

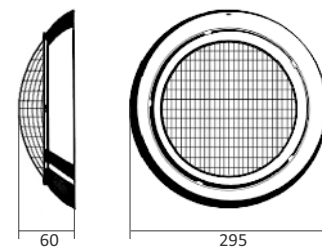

CODE	DESCRIPTION	SPOT	PACKING	WEIGHT kg	VOLUME m <sup>3</sup>
E-132-150	U/W Flat light halogen bulb	150W - 12V AC	1	2.5	0.015
E-132-200	U/W Flat light halogen bulb	200W - 12V AC	1	2.5	0.015
E-132-108W	U/W Flat light 108 LED - White	8W - 12V AC	1	2.5	0.015
E-132-108C	U/W Flat light 108 LED - Color changing	2-8W - 12V AC	1	2.5	0.015
E-132-252W	U/W Flat light 252 LED - White	18W - 12V AC	1	2.5	0.015
E-132-252C	U/W Flat light 252 LED - Color changing	3-18W - 12V AC	1	2.5	0.015
E-132-546W	U/W Flat light 546 LED - White	22W - 12V AC AC	1	2.5	0.015
E-132-546C	U/W Flat light 546 LED - Color changing	9-22W - 12V AC	1	2.5	0.015

## 8- STAINLESS STEEL "MINI FLUSH" LIGHT

- Stainless steel under water light Ø120 mm.
- For concrete pools.
- Perfect for spas and stairs.
- Wall mounting by screws.
- Protection IP68.

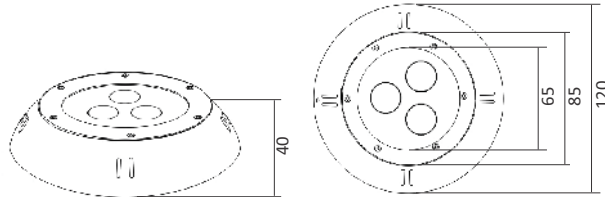

CODE	DESCRIPTION	SPOT	PACKING	WEIGHT	VOLUME
				kg	m <sup>3</sup>
E-138	Flush light with halogen lamp	100W - 12V AC	1	2	0.005
E-139	Single color light with 3 LEDs	3x1W - 15V AC	1	2	0.005

## 9- STAINLESS STEEL UNDERWATER LIGHT FOR SPA "DECORATIVO"

- World standard of reliability.
- AISI-316L Stainless steel.
- Prismatic tempered glass lense.
- Stainless steel face with clamp.
- Heat-sensing cut off device for low water level.
- Includes red and blue lenses.
- Protection IP68.

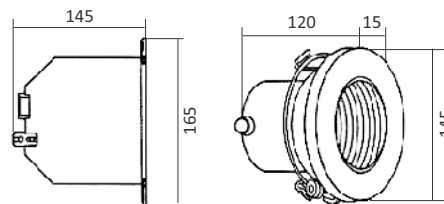

POOL	CODE	SPOT	PACKING	WEIGHT	VOLUME
				kg	m <sup>3</sup>
Concrete	E-140	100W - 12V AC	2	3	0.02

# Electrical Equipment

## 10- AQUA FOUNTAIN LIGHT

- Led lamp designed especially for the enhancement of fountains and water games.
- With 120° wide beam lens and built-in color change system.
- Can autonomously generate 10 fixed colors and 6 color sequences. Does not require DMX control box.
- Adjustable 316L STAINLESS steel bracket
- Electric connection cable 10m.
- Protection degree IP68 3m.



CODE	DESCRIPTION	SPOT	TOTAL OUTPUT	PACKING	WEIGHT	VOLUME
					kg	m <sup>3</sup>
200301023	White Led light PAR 56	30W - 12V	1800 Lumens	1	1.1	0.003
200301026	Led light with changing RGB colors PAR 56	30W - 12V	1015 Lumens	1	1.1	0.003
200301025	White Led light	8W - 12V	350 Lumens	1	0.8	0.002
200301025	Led light with changing RGB colors ø193	10W - 12V	350 Lumens	1	0.8	0.002
200300030	Remote control & Receiver for multicolor LED Maximum 300WATT			1	0.5	0.002

## 11- STAINLESS STEEL FOUNTAIN LIGHT

- AISI-316 Stainless Steel underwater fountain light 50W - 12V.
- Can be fixed on the floor with screws, with 4 meters cable.
- Protection IP68.

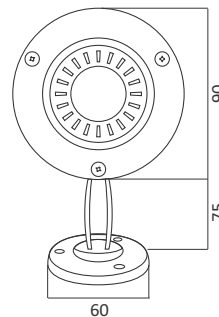

CODE	DESCRIPTION	SPOT	PACKING	WEIGHT	VOLUME
				kg	m <sup>3</sup>
E-136	Fountain light with halogen bulb PAR 56	50W - 12V	1	1.5	0.003

## 12- STAINLESS STEEL HALOGEN LIGHTS

### ROUND HALOGEN LIGHTS

- Made from Stainless Steel AISI-316L V4A for durable use.
- With 3m cable.
- Protection IP68.



CODE	DESCRIPTION	WATT	Ø	PACKING	WEIGHT	VOLUME
					kg	m <sup>3</sup>
		12V-AC	mm			
29250	S.S. Mini light "Mignon" threaded 1¼"	20/35	82	1		
29251	S.S. Mini light "Mignon" threaded and ferrule 1¼"	20/35	82	1		
29252	S.S. Mini light "Mignon" with recess for concrete	20/35	82	1		
29253	S.S. Mini light "Mignon" with recess for liner	20/35	82	1		
29512	S.S Mini light threaded 2"	50/65	106	1		
29515	S.S. Mini light threaded and ferrule 2"	50/65	106	1		
29518	S.S Mini Halogen light with recess for concrete	50/65	106	1		
29521	S.S Mini Halogen light with recess for liner	50/65	106	1		
29505	S.S. Medium halogen light with recess for concrete	100	160	1		
29507	S.S. Medium halogen light with recess for liner	100	160	1		
29506	S.S. Medium halogen light with recess for concrete	150	160	1		
29508	S.S. Medium halogen light with recess for liner	150	160	1		

### SQUARE HALOGEN LIGHTS

- Made from Stainless Steel AISI-316L V4A for durable use.
- With recess and 3m cable.
- Protection IP68.



CODE	DESCRIPTION	RECESS	WATT	PACKING	WEIGHT	VOLUME
			12V-AC		kg	m <sup>3</sup>
29800	S.S. Mini halogen light 120 x 120mm for concrete	Steel	50/60	1		
29804	S.S. Mini halogen light 120 x 120mm for liner	Steel	50/60	1		
29808	S.S. Medium halogen light 200 x 200mm for concrete	Steel	100	1		
29812	S.S. Medium halogen light 200 x 200mm for liner	Steel	100	1		
29809	S.S. Medium halogen light 200 x 200mm for concrete	Steel	150	1		
29813	S.S. Medium halogen light 200 x 200mm for liner	Steel	150	1		
29866	S.S. Standard halogen light 320 x 320mm for concrete	Steel	300	1		
29867	S.S. Standard halogen light 320 x 320mm for liner	Steel	300	1		
39100	S.S. Standard halogen light 320 x 320mm for concrete	ABS	300	1		
39101	S.S. Standard halogen light 320 x 320mm for liner	ABS	300	1		



# Electrical Equipment



## 13- STAINLESS STEEL ROUND LED LIGHTS

### WHITE COLOR

- Made from Stainless Steel AISI-316L V4A for durable use.
- With 3m cable.
- Protection IP68.

CODE	DESCRIPTION	WATT 12V-AC	Ø mm	PACKING	WEIGHT kg	VOLUME m <sup>3</sup>
29100	S.S. Mini light 3 LED threaded and ferrule 2"	3	106	1		
29102	S.S. Mini light 3 LED with steel recess for concrete	3	116	1		
29103	S.S. Mini light 3 LED with steel recess for liner	3	116	1		
39102	S.S. Mini light 3 LED with ABS recess for concrete	3	116	1		
39103	S.S. Mini light 3 LED with ABS recess for liner	3	116	1		
29530	S.S. Medium 6 LED light with steel recess for concrete	6	160	1		
29531	S.S. Medium 6 LED light with ABS recess for liner	6	160	1		
39530	S.S. Medium 6 LED light with ABS recess for concrete	6	160	1		
39531	S.S. Medium 6 LED light with steel recess for liner	6	160	1		
29706	S.S. Light 15 LED PAR 56 for Concrete	50	290	1		
29707	S.S. Light 15 LED PAR 56 for Liner	50	290	1		
39534	S.S. Medium 15 LED light with ABS recess for concrete	50	290	1		
39535	S.S. Medium 15 LED light with ABS recess for liner	50	290	1		

Note: Various colors (blue/red/green/amber) available for lights (3/6) LED



## RGB COLOR CHANGE DMX

- Made from Stainless Steel AISI-316L V4A for durable use.
- With 3m cable.
- Protection IP68.

CODE	DESCRIPTION	WATT 24V-DC	Ø mm	PACKING	WEIGHT kg	VOLUME m <sup>3</sup>
29941	Mini light 3 LED threaded and ferrule	3	106	1		
29942	Mini light 3 LED with steel recess for concrete - cable mt. 15 x c.a.	3	116	1		
29943	Mini light 3 LED with steel recess for liner - cable mt. 15 x c.a.	3	116	1		
39942	Mini light 3 LED with ABS recess for concrete - cable mt. 15 x c.a.	3	116	1		
39943	Mini light 3 LED with ABS recess for liner - cable mt. 15 x c.a.	3	116	1		
29920	9 LED light with steel recess for concrete - cable mt. 15 x c.a.	9	160	1		
29921	9 LED light with steel recess for liner - cable mt. 15 x c.a.	9	160	1		
39920	9 LED light with ABS recess for concrete - cable mt. 15 x c.a.	9	160	1		
39921	9 LED light with ABS recess for liner - cable mt. 15 x c.a.	9	160	1		
29944	21 LED light with recess for concrete - cable mt. 10 x c.a.	21	230	1		
29945	21 LED light with recess for liner - cable mt. 10 x c.a.	21	230	1		
29939	Remote control + effect DMX control generator (LED 3 x 10pcs or LED 9 x 10pcs or 21 x 5pcs)	-	-	1		

## RGB COLOR CHANGE

- Made from Stainless Steel AISI-316L V4A for durable use.
- With 3m cable.
- Protection IP68.



CODE	DESCRIPTION	WATT 12V-AC	Ø mm	PACKING	WEIGHT kg	VOLUME m <sup>3</sup>
31110	S.S. Light 3 LED RGB with Steel recess for Concrete	3	116	1		
31111	S.S. Light 3 LED RGB with Steel recess for Liner	3	116	1		
39912	S.S. Light 3 LED RGB with ABS recess for Concrete	3	116	1		
39913	S.S. Light 3 LED RGB with ABS recess for Liner	3	116	1		
31112	S.S. Light 18 LED RGB with Steel recess for Concrete	10	160	1		
31113	S.S. Light 18 LED RGB with Steel recess for Concrete	10	160	1		
39914	S.S. Light 18 LED RGB with ABS recess for Concrete	10	160	1		
39915	S.S. Light 18 LED RGB with ABS recess for Concrete	10	160	1		
29700	S.S. Super light 531 LED with ABS recess for Concrete	50	290	1		
29700P	S.S. Super light 531 LED with ABS recess for Liner	50	290	1		
29720	RGB Color Change Remote Control + Receiver + receiving for 5 Nos of LED light	-	-	1		

## 14- ULTRA FLAT STAINLESS STEEL ROUND/SQUARE LED LIGHTS - WHITE & RGB CHANGE COLOR

- Made from Stainless Steel AISI-316L V4A for durable use.
- With 3m cable.
- Protection IP68.



CODE	DESCRIPTION	WATT	Dimensions mm	PACKING	WEIGHT kg	VOLUME m <sup>3</sup>
29902	Ultraflat light 531 LED - white color- for concrete - Round	50	Ø290 - H 30	1		
29903	Ultraflat light 531 LED - white color- for concrete - Square	50	290 x 290 - H 30	1		
29525	Ultraflat light 18 LED - white color- for concrete - Round	18	Ø186	1		
29914	Ultraflat light 531 LED - RGB color change - for concrete - Round	50	Ø290 - H 30	1		
29915	Ultraflat light 531 LED - RGB color change - for concrete - Square	50	290 x 290 - H 30	1		
29524	Ultraflat light 18 LED - RGB color change - for concrete - Round	18	Ø186	1		
29720	RGB Color Change Remote Control + Receiver + receiving for 5 Nos of LED light	-	-	1		

# Electrical Equipment



## 15- LED LIGHT "AQUALUXE"

- The AQUALUXE led lamp is simple and based on revolutionary construction with patent, that can allow the use of high power led into a body entirely in poly carbonate.
- The high precision of injection molds makes the structure completely sealed and impervious to oxidation.
- Able to generate a high brightness (about 2000 lumens) with very little consumption.
- Operation with standard transformers 12V AC allows easy replacement in existing systems.
- The color changing version is controlled either through on-off or by remote control.
- IP 68 protection rate.

CODE	DESCRIPTION	SPOT	TOTAL OUTPUT	RECOMMENDED INSTALLATION	PACKING	WEIGHT		VOLUME
						kg	m <sup>3</sup>	
200300013	AQUALUXE LED Lighr - white	30W - 12V	1800 Lumens	1 lamp per 25m <sup>2</sup>	1	1	0.008	
200300014	AQUALUXE LED Lighr - color	30W - 12V	1015 Lumens	1 lamp per 18m <sup>2</sup>	1	1	0.008	
200300026	AQUALUXE power white lamp	50W - 12V	3700 Lumens	1 lamp per 50m <sup>2</sup>	1	0.3	-	
200300027	AQUALUXE power lamp changing colors	50W - 12V	3500 Lumens	1 lamp per 45m <sup>2</sup>	1	0.3	-	
200300030	Remote control & Receiver for multicolor LED Maximum 300WATT				1	0.5	0.002	

## 16- SPOT LIGHT LED

- For public and private pools with structures in panels and concrete
- Skimmer technology
- Overflow edge technology
- Particularly suitable for public structures and hospitality facilities
- Protection degree IP68

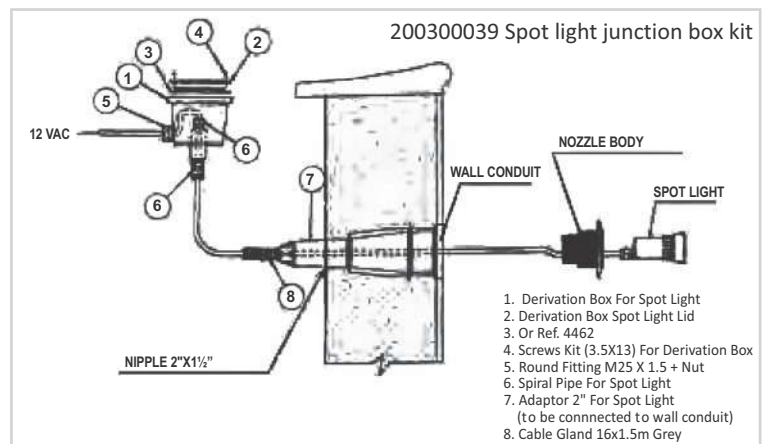

CODE	DESCRIPTION	SPOT	TOTAL OUTPUT	COVERAGE AREA	PACKING	WEIGHT		VOLUME
						kg	m <sup>3</sup>	
200300035	ABS spot light LED white	3W - 12V AC	200 Lumen	3m <sup>2</sup>	1	1	0.008	
200300036	ABS spot light LED white	10W - 12V AC	600 Lumen	8m <sup>2</sup>	1	1	0.008	
200300037	ABS spot light LED RGB	10W - 12V AC	350 Lumen	8m <sup>2</sup>	1	1	0.008	
200300030	Remote control & Receiver for multicolor LED Maximum 300WATT				1	0.5	0.002	
200200686	Wall conduit 25cm				1	0.2	0.004	
100200446	Socket 2"X 1/2"				1	0.2	0.004	
200300039	Spot light junction box kit				1			

## 17- UNDERWATER LAMP



CODE	DESCRIPTION	SPOT	PACKING	WEIGHT kg	VOLUME m <sup>3</sup>
200300012	Lamp PAR-56	300W - 12V	1		
200300301	Lamp Halogen	100W - 12V	1		
200300302	Lamp Dichroic	50W - 12V	1		

## 18- UNDERWATER LED BULBS & REMOTE

- PAR56 bulb completely in water proof plastic body.
- With stainless steel 316 heat diffusing ring.



CODE	DESCRIPTION	SPOT	PACKING	WEIGHT kg	VOLUME m <sup>3</sup>
E-120	144 LED Warm White or Single Color bulb	12W - 12V	1		
E-121	252 LED Warm White or Single Color bulb	25W - 12V	1		
E-121-C	252 LED RGB Color Changing bulb (receiver included in bulb)	25W - 12V	1		
E-121-R	Remote controller for E-121-C		1		

## 19- LEONARDO SPOT LAMP

- Compatible with swimming pool light 50W.
- Impulse color change through on-off switch.
- Available in 2 version.
  - Leonardo color: 8 color programs, consumption 5W, beam aperture 120°.
  - Leonardo white: white light, consumption 6W, beam aperture 120°.



CODE	DESCRIPTION	SPOT	PACKING	WEIGHT kg	VOLUME m <sup>3</sup>
200300305	Leonardo Lamp 30 LED - Multicolor	5W - 12V	1		
200300306	Leonardo Lamp 3 LED - White	6W - 12V	1		
200300312	Receiver for remote control		1		
200300313	Remote control for LED lamp		1		

## 20- FLEXIBLE CONNECTION CABLE

CODE	PACKING	WEIGHT kg	VOLUME m <sup>3</sup>
200300010	1		



# Electrical Equipment



## 21- ABS CONNECTION BOXES

- For connections between lights.
- Constructed of white, UVA-resistant ABS plastic.
- Fully leakproof with O-ring for cover and gland seals for outlets.
- IP 68 Protection rate.

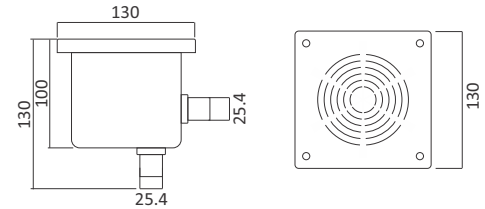

CODE	DIMENSIONS L x W x H	PACKING	WEIGHT kg	VOLUME m <sup>3</sup>
200300009	13.5 x 13.5 x 10.5	40	15	0.1

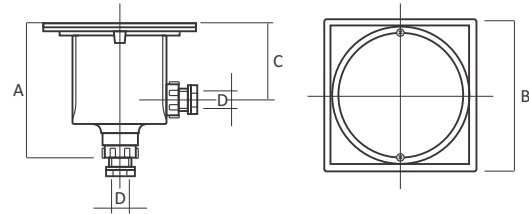

CODE	DIMENSIONS				PACKING	WEIGHT kg	VOLUME m <sup>3</sup>
	A	B	C	D			
E-241	133	149	78	3/4"	16	8	0.075

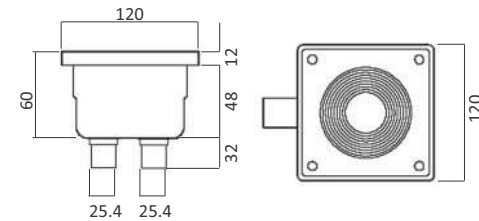

CODE	PACKING	WEIGHT kg	VOLUME m <sup>3</sup>
E-242	16		

## 22- STAINLESS STEEL CONNECTION BOX

- Made of AISI-316 stainless-steel.
- For connections between lights.
- Fully leakproof with O-ring for cover and gland seals for outlets.
- IP 68 Protection rate.

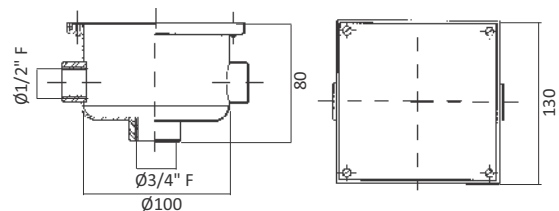

CODE	PACKING	WEIGHT kg	VOLUME m <sup>3</sup>
E-244	1		



## 23- CASCADE TRANSFORMER

- IP64 Complete waterproof transformer with cables for fast wiring.
- Its high quality guarantees its very long life under heavy duty conditions.
- Input 230v-240v, Output 12,14 and 16v. 50/60 HZ.
- Specially recommended for humid areas and where water is close.
- Manufactured under European norms, CE certified.

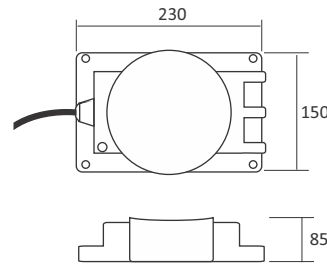

**E-245 CIRCUIT DIAGRAM**

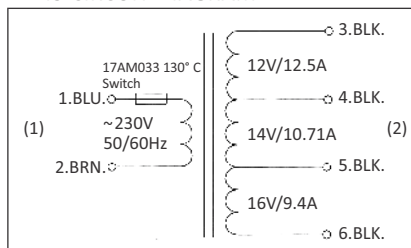

**E-246 CIRCUIT DIAGRAM**

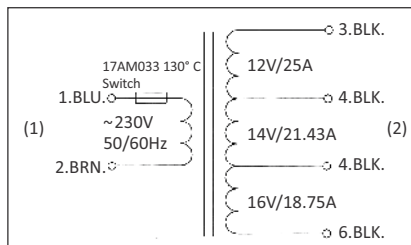

**E-247 CIRCUIT DIAGRAM**

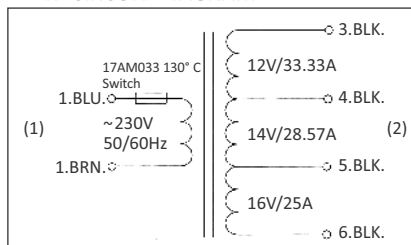

**E-248 CIRCUIT DIAGRAM**

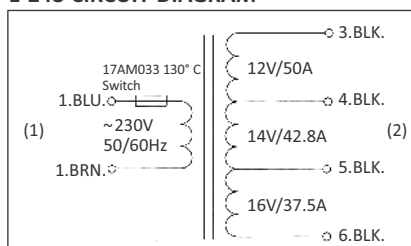

CODE		UNLOAD VOLTAGE (V±5%) AC	LOADING VOLTAGE (V±5%) AC	RATED CURRENT (A)
E-245	S1:3~4	0 ~ 13.1V	0 ~ 12V	12.5A
	S1:3~5	0 ~ 15.2V	0 ~ 14V	10.71A
	S1:3~6	0 ~ 17.65V	0 ~ 16V	9.4A
E-246	S1:3~4	0 ~ 12.68V	0 ~ 12V	25A
	S1:3~5	0 ~ 14.87V	0 ~ 14V	21.43A
	S1:3~6	0 ~ 17.05V	0 ~ 16V	18.75A
E-247	S1:3~4	0 ~ 12.32V	0 ~ 12V	33.33A
	S1:3~5	0 ~ 14.67V	0 ~ 14V	28.57A
	S1:3~6	0 ~ 17.01V	0 ~ 16V	25A
E-248	S1:3~4	0 ~ 12.6V	0 ~ 12V	50A
	S1:3~5	0 ~ 14.7V	0 ~ 14V	42.8A
	S1:3~6	0 ~ 16.8V	0 ~ 16V	37.5A

CODE	POWER W	CURRENT mA	PACKING	WEIGHT kg	VOLUME m³
E-245	150	50	1	4	0.003
E-246	300	60	1	5	0.003
E-247	400	80	1	6	0.003
E-248	600	85	1	7	0.003

# Electrical Equipment



## 24- LED WALL WASHER LINEAR TUBE LIGHTS

- This linear wall washer series adopt the low power LED as the light source, which could produce a mixed color changing effect and can produce more than 16 million colors.
- This product adopt aluminum-alloy lamp body, transparent glass and are simple shaped, easy to install and cost-effective.
- Voltage: 24 V DC
- Operating temperature: -30° C - +50°C
- IP Rating; IP 65

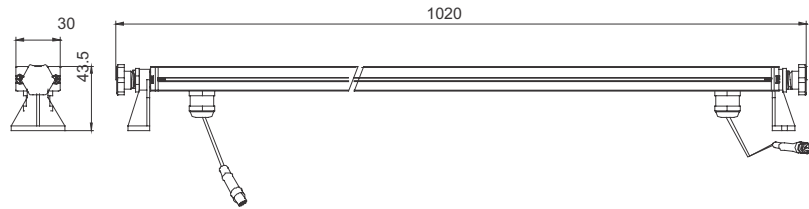

CODE	POWER	LIGHT SOURCE	LED QTY	COLOR	PACKING	WEIGHT kg	VOLUME m <sup>3</sup>
LTLWW01	6 W	3528 RGB LED	84 PCS	RGB	1		
LTLWW02	15 W	5050 LED	60 PCS	R/G/B/Y/W/WW	1		

Kindly add -R Red, -G for green, -B for blue, -Y for yellow, -W for white, -WW for warm white



## WASHER-100

- Stand alone controller
- For easy changing the color (pre-set program from factory)
- Can be connected with SRC174-DMX



## SRC174-DMX

- Controller with 192 channels
- DMX output channels: 192
- Power input: DC 9-12V 300ma min
- Weight: 2.7kg
- DMX output: 2 (1 3-pin XLR female, 1 3-pin XLR male)
- Midi: 5-pin DIN,
- Voltage: AC 120/240V 50/60Hz,
- Dimensions: 1' 8.3" x 6.3" x 3.5"(LxWxH)
- Power load 750KW, recommend to connect up to 600WATT
- Max distance between light and control is 100mtr, if more a power booster is required.

## LTLWW-CABLE05

Extendable cable 5mtr with male and female connector

## LTLWW-CABLE10

Extendable cable 10mtr with male and female connector

## 25- LED AQUA FOUNTAIN LIGHT

- LED Aqua series(Power LED RGB) is a energy savings underwater LED lighting fixture which utilizes high power 1W (RGB) LEDs as the light source.
- The LED Aqua series offers high power RGB full color mixing LED illumination for applications such as fountain, pond, water feature illumination, and any application with direct or indirect constant water immersion.
- Voltage: 24 V DC
- Operating temperature: -20° C - +40°C
- IP Rating; IP 68

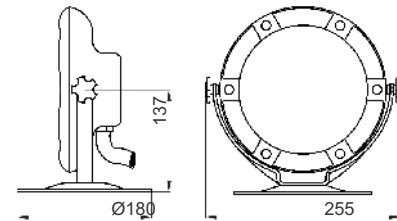

CODE	POWER	LIGHT SOURCE	COLOR	PACKING	WEIGHT	VOLUME
					kg	m <sup>3</sup>
LEDAFL01	24 W	18x1W high power LED	RGB 16.7 million	1		
LEDAFL02	25 W	18x1W high power LED	R/G/B/Y/W	1		

Kindly add -R Red, -G for green, -B for blue, -Y for yellow, -W for white

## WASHER-100

- Stand alone controller
- For easy changing the color (pre-set program from factory)
- Can be connected with SRC174-DMX



## SRC174-DMX

- Controller with 192 channels
- DMX output channels: 192
- Power input: DC 9-12V 300ma min
- Weight: 2.7kg
- DMX output: 2 (1 3-pin XLR female, 1 3-pin XLR male)
- Midi: 5-pin DIN,
- Voltage: AC 120/240V 50/60Hz,
- Dimensions: 1' 8.3" x 6.3" x 3.5"(LxWxH)
- Power load 750KW, recommend to connect up to 600WATT
- Max distance between light and control is 100mtr, if more a power booster is required.



## LEDAFLPS

- To be used with LEDAFL02
- Power supply case 240V-220V TO 24V, 50/60HZ



## LEDAFLDB

- Power distribution box for high power led aqua fountain light
- Maximum can connect 6pcs of high power led aqua fountain light
- 4pcs can be connected to one LEDAFLPS. Therefore, you can reach up to 24 LEDAFL01 in one system



# Electrical Equipment

## CONNECTION MODE

Example 1

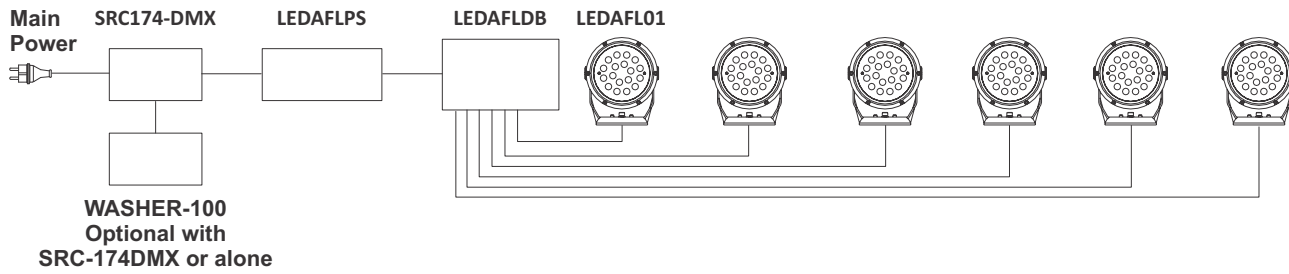

Example 2

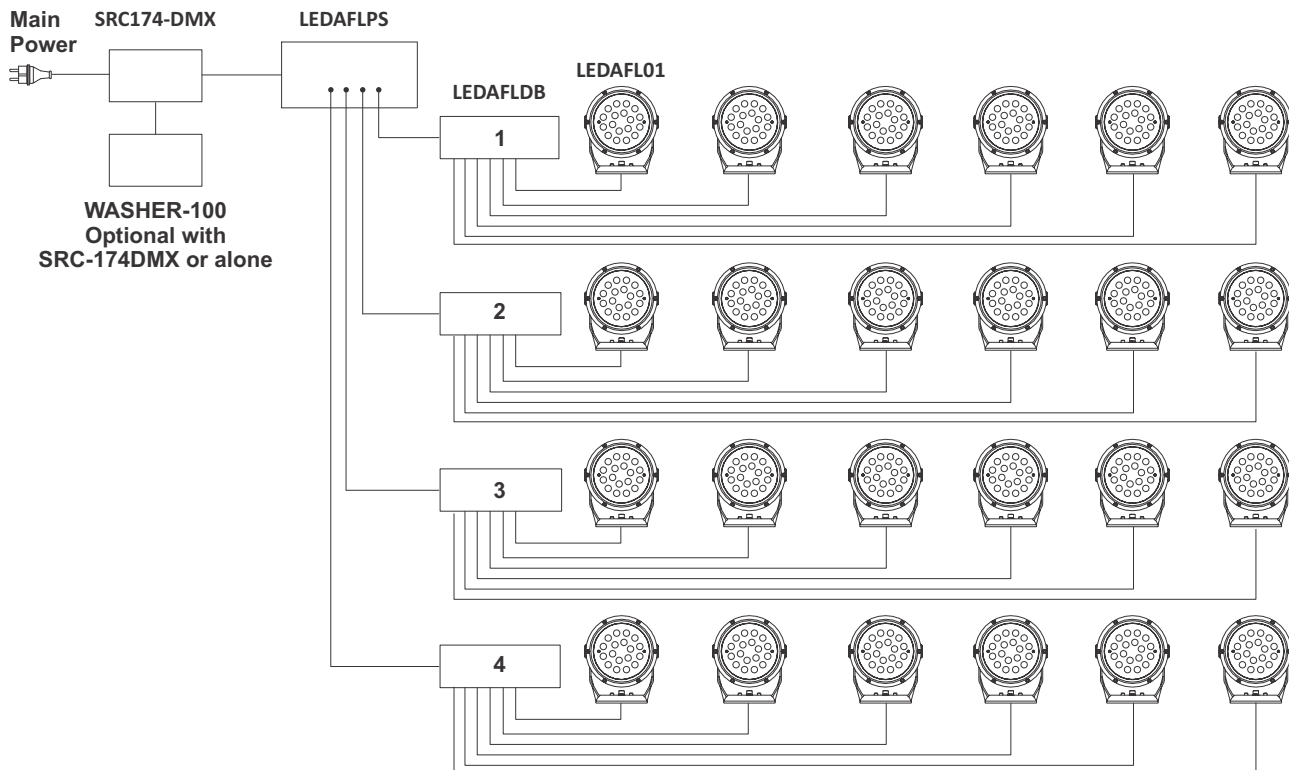

### 26- LED TAPE LIGHT

- High quality LEDs
- High lumens output
- Low energy consumption and eco-friendly
- Low voltage, low heat, high safety
- Flexible light body

CODE	VOLTAGE	SIZE (mm)	LED SPACING (cm)	LED QTY/M	LED COLOR	CUTTING UNIT	PACKING	WEIGHT	VOLUME
LEDTL02	24V	5 x 15	1.67	60 pcs	W/WW/B/G/R/Y/A	0.1 m	1	kg	m <sup>3</sup>

Kindly add -R Red, -G for green, -B for blue, -Y for yellow, -W for white, -WW for warm white, -A for amber light

## 27- INSULATING GEL IP68

- The isolant gel IP68 is the fluid, simple to use, precise product of high quality.
- Put down "A component" into the "B component", mix them for 15 seconds and apply the ready gel on the cable paying particular attention to the position of it. The time limit for this operation is approximately 1 minute at the room temperature. It takes approximately 5 minutes to make the gel become completely hard.



CODE	DESCRIPTION	PACKING	WEIGHT	VOLUME
			kg	m <sup>3</sup>
200300000R	Insulating gel IP68	1		